

CSE 332 Winter 2024

Lecture 9: AVL Trees and B-Trees

Nathan Brunelle

<http://www.cs.uw.edu/332>

Dictionary (Map) ADT

- Contents:
 - Sets of key+value pairs
 - Keys must be comparable
- Operations:
 - insert(key, value)
 - Adds the (key,value) pair into the dictionary
 - If the key already has a value, overwrite the old value
 - Consequence: Keys cannot be repeated
 - find(key)
 - Returns the value associated with the given key
 - delete(key)
 - Remove the key (and its associated value)

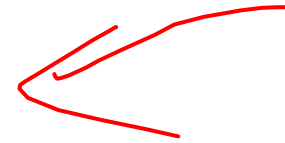

Dictionary Data Structures

Data Structure	Time to insert	Time to find	Time to delete
Unsorted Array	$\Theta(n)$	$\Theta(n)$	$\Theta(n)$
Unsorted Linked List	$\Theta(n)$	$\Theta(n)$	$\Theta(n)$
Sorted Array	$\Theta(n)$	$\Theta(\log n)$	$\Theta(n)$
Sorted Linked List	$\Theta(n)$	$\Theta(n)$	$\Theta(n)$
Binary Search Tree	$\Theta(n)$	$\Theta(n)$	$\Theta(n)$
AVL Tree	$\Theta(\log n)$	$\Theta(\log n)$	$\Theta(\log n)$

AVL Tree

- A Binary Search tree that maintains that the left and right subtrees of every node have heights that differ by at most one.
 - height of left subtree and height of right subtree off by at most 1
 - Not too weak (ensures trees are short)
 - Not too strong (works for any number of nodes)
- Idea of AVL Tree:
 - When you insert/delete nodes, if tree is “out of balance” then modify the tree
 - Modification = “rotation”

Not Balanced!

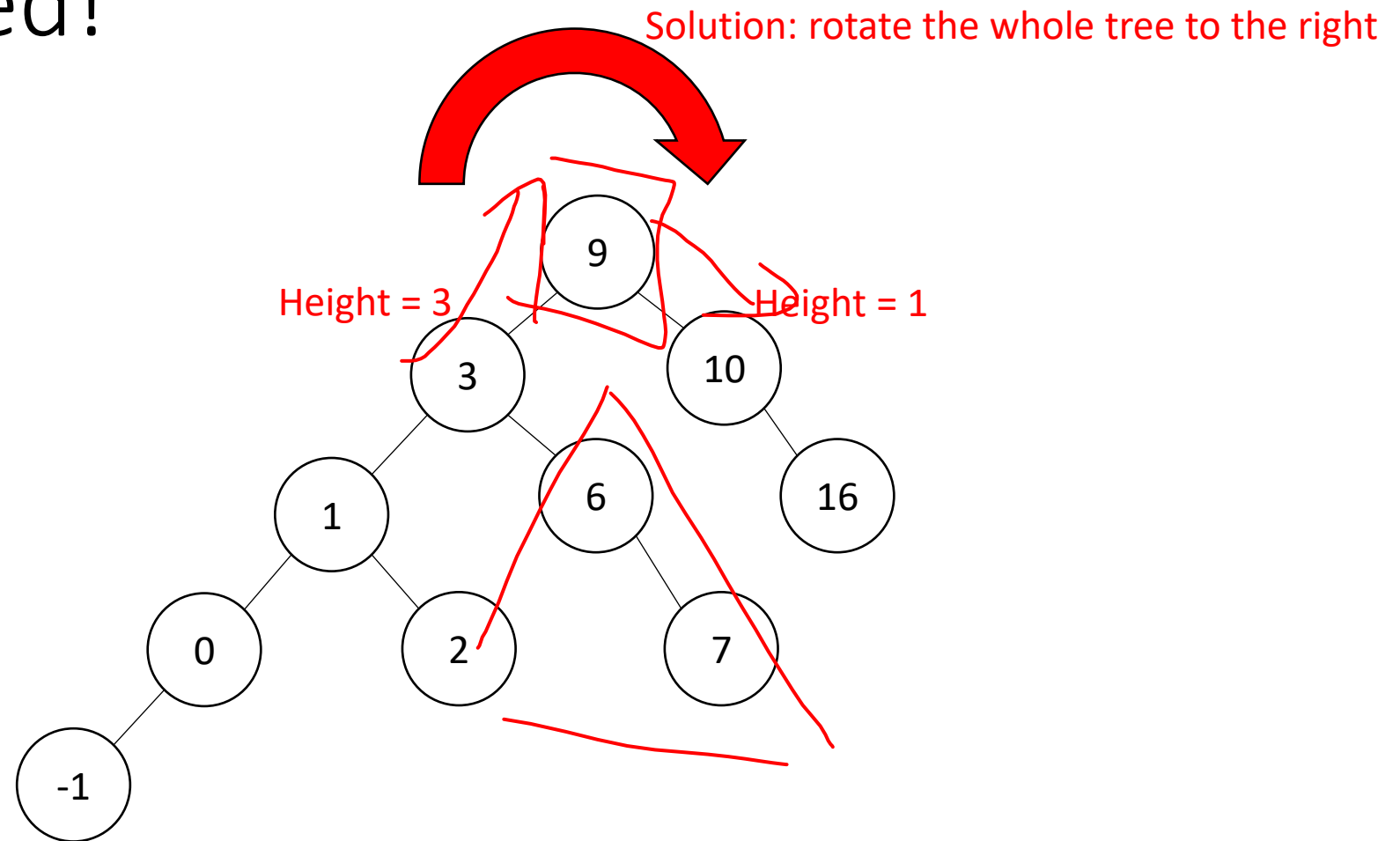

Balanced!

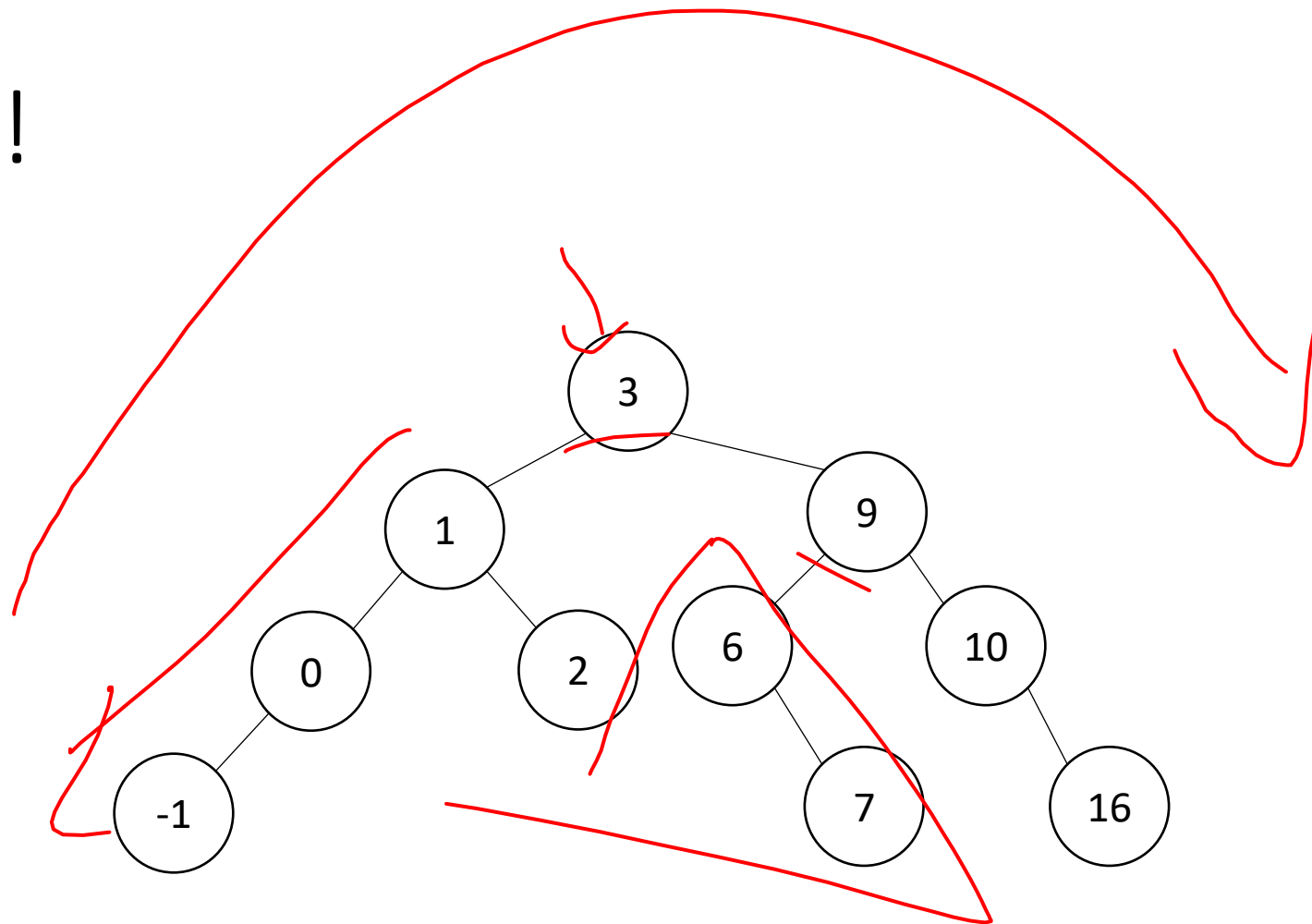

Right Rotation

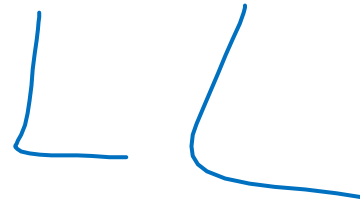

- Make the left child the new root
- Make the old root the right child of the new
- Make the new root's right subtree the old root's left subtree

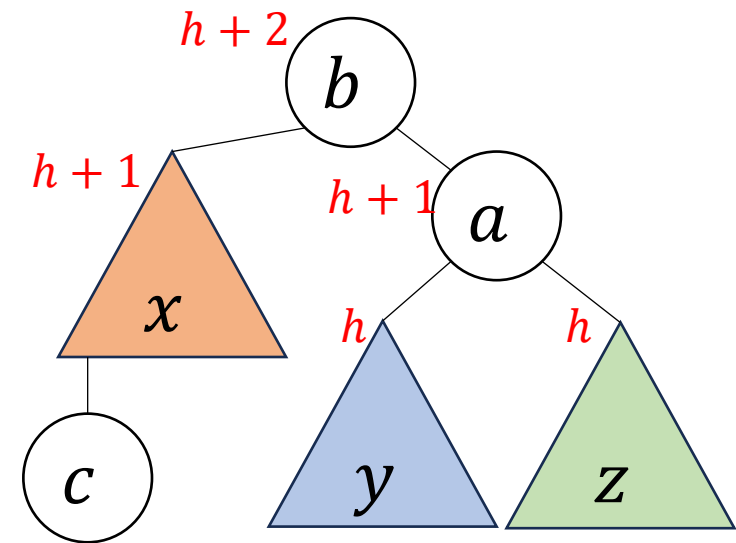
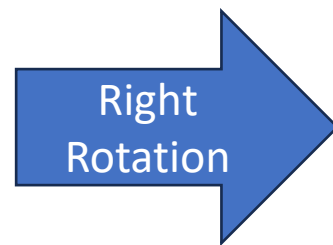
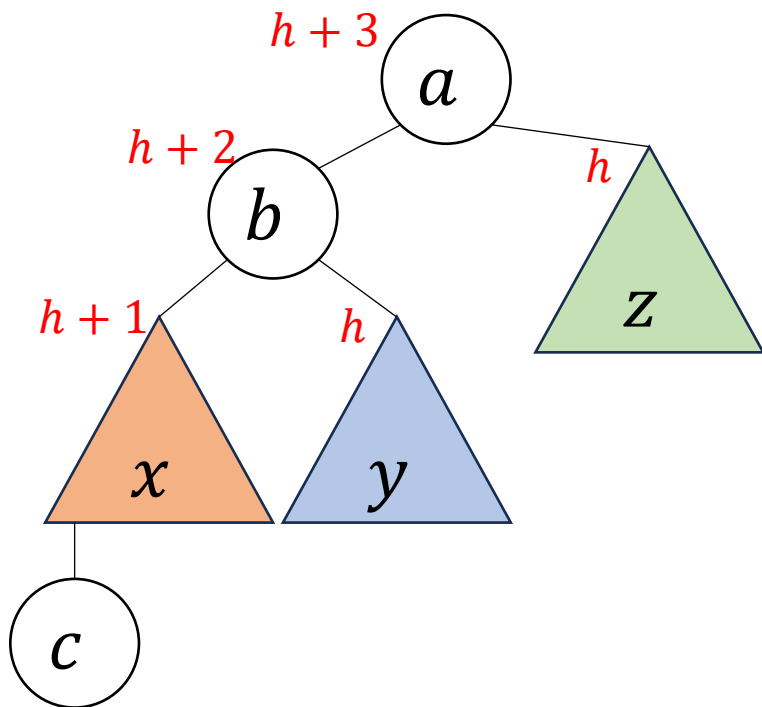

Insert Example

20

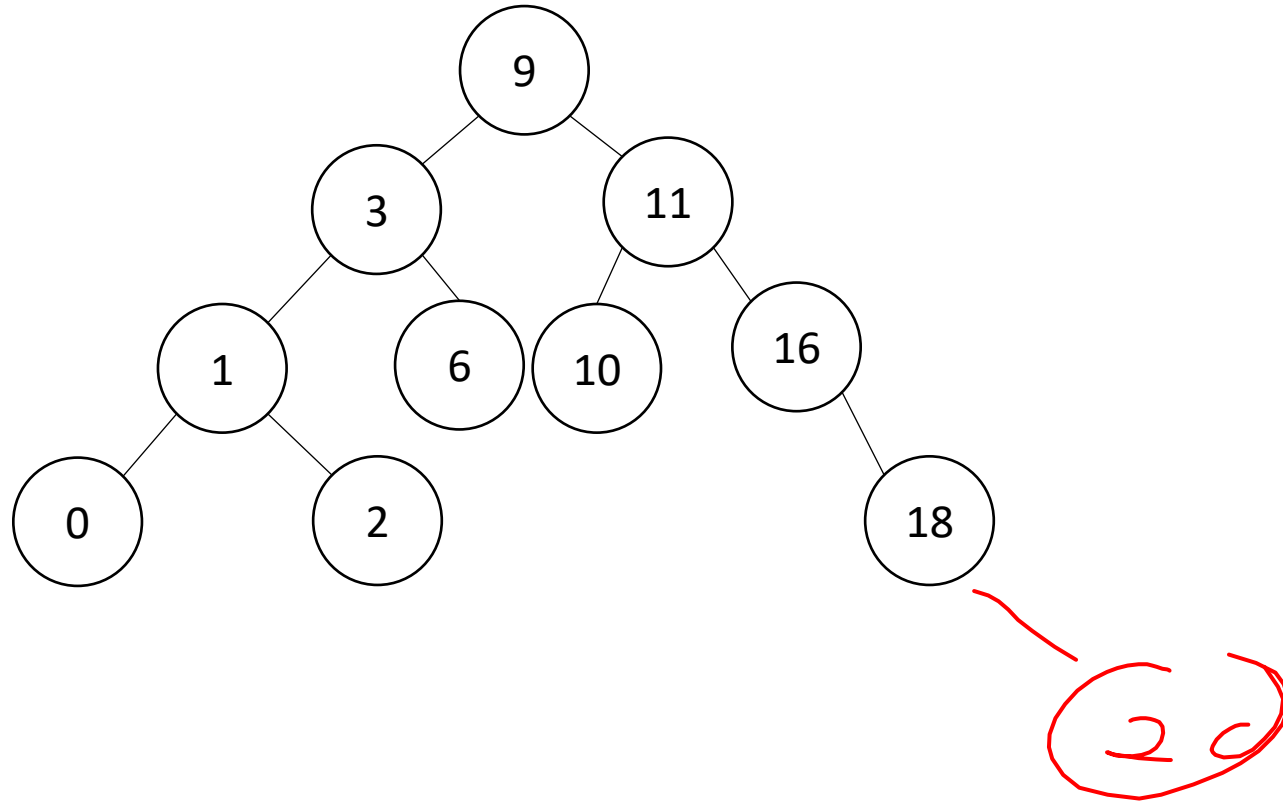

Not Balanced!

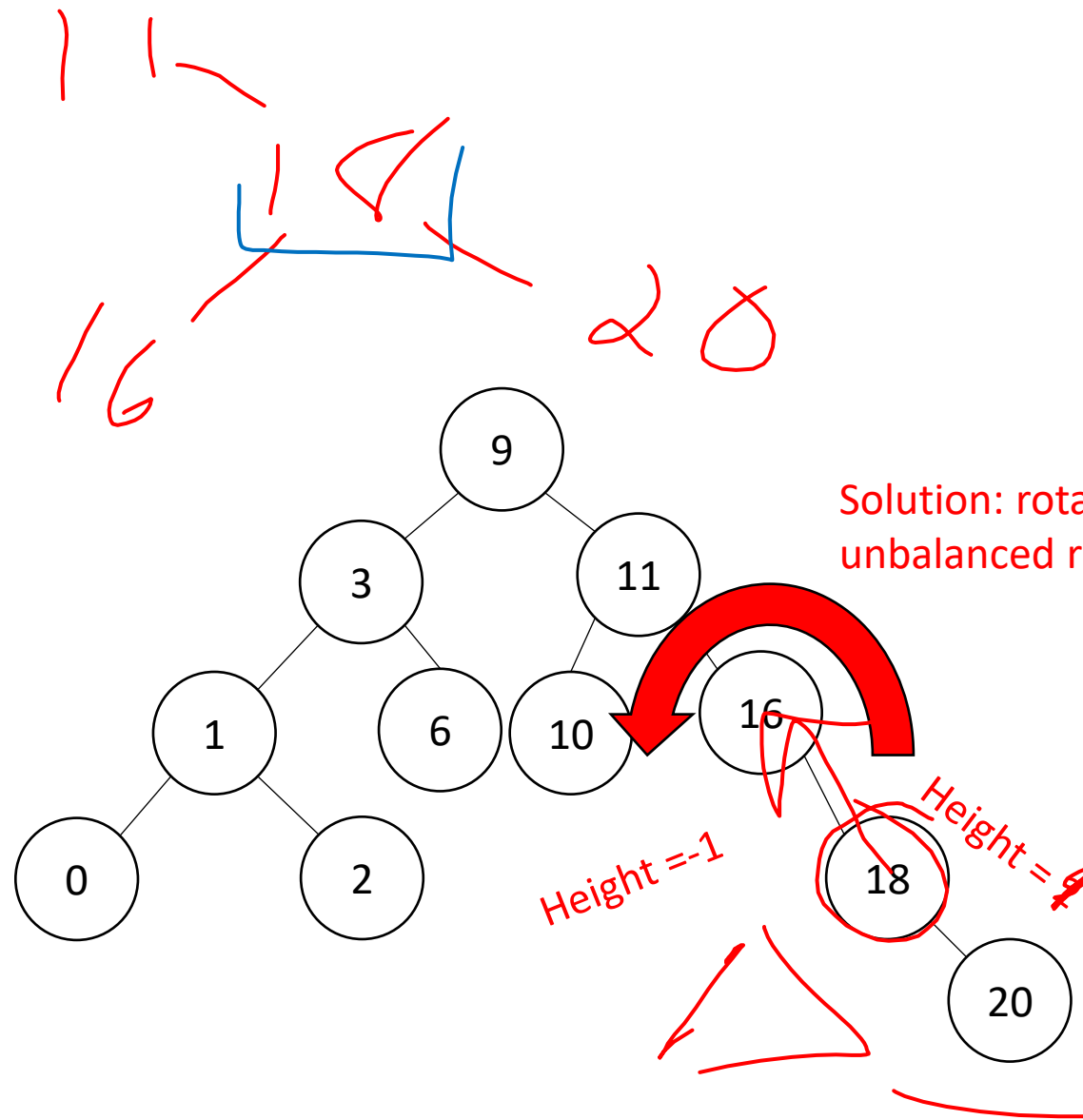
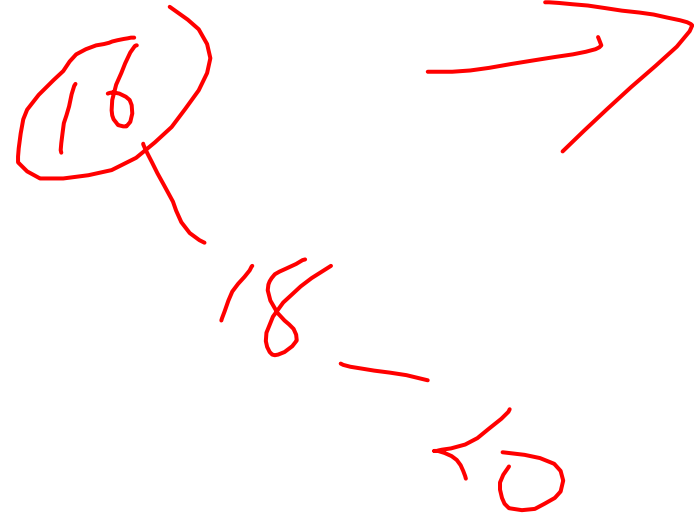

Balanced!

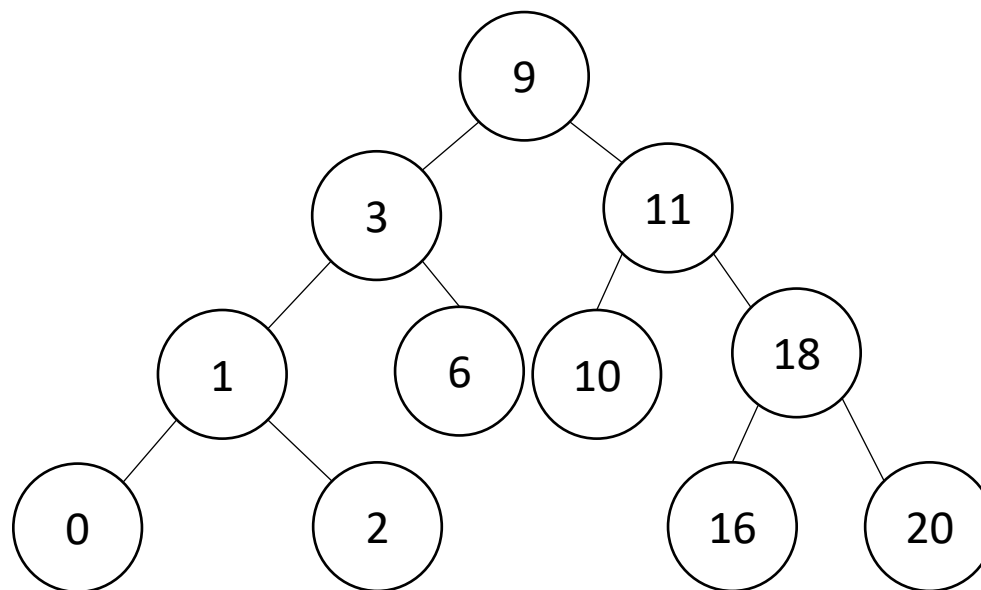

Left Rotation

RR

- Make the right child the new root
- Make the old root the left child of the new
- Make the new root's left subtree the old root's right subtree

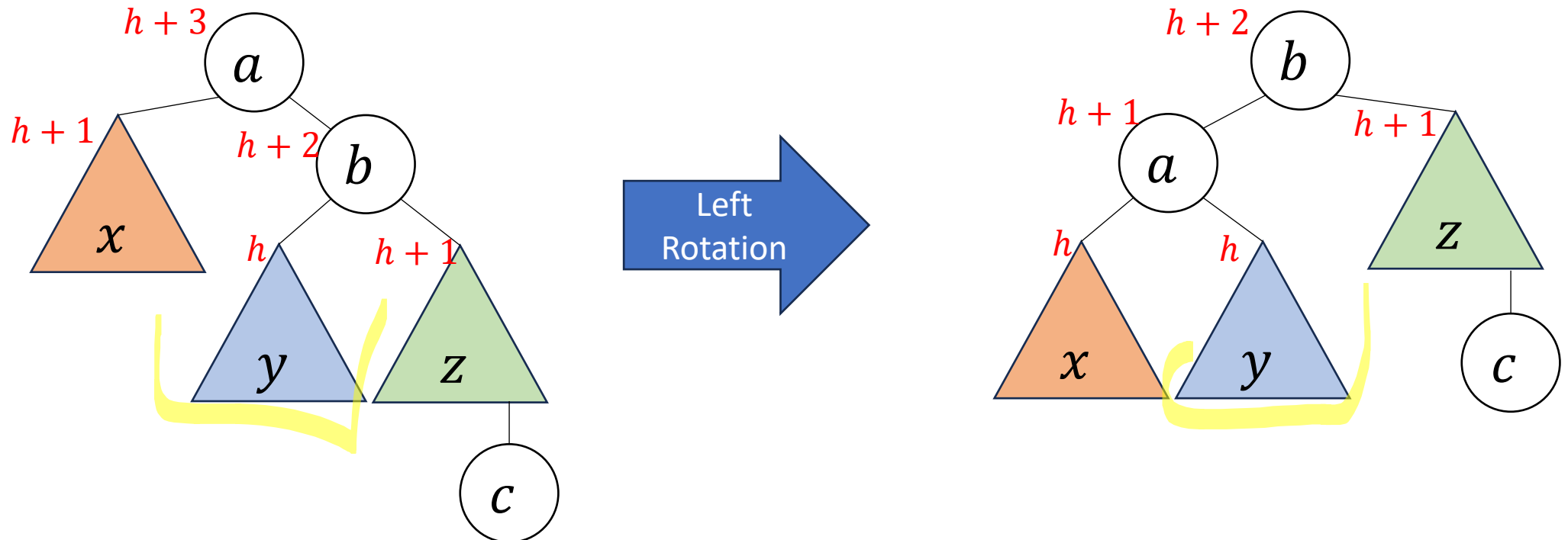

Insertion Story So Far

- After insertion, update the heights of the node's ancestors
- Check for unbalance
- If unbalanced then at the deepest unbalanced root:
 - If the left subtree was deeper then rotate right
 - If the right subtree was deeper then rotate left

This is incomplete!
There are some cases
where this doesn't work!

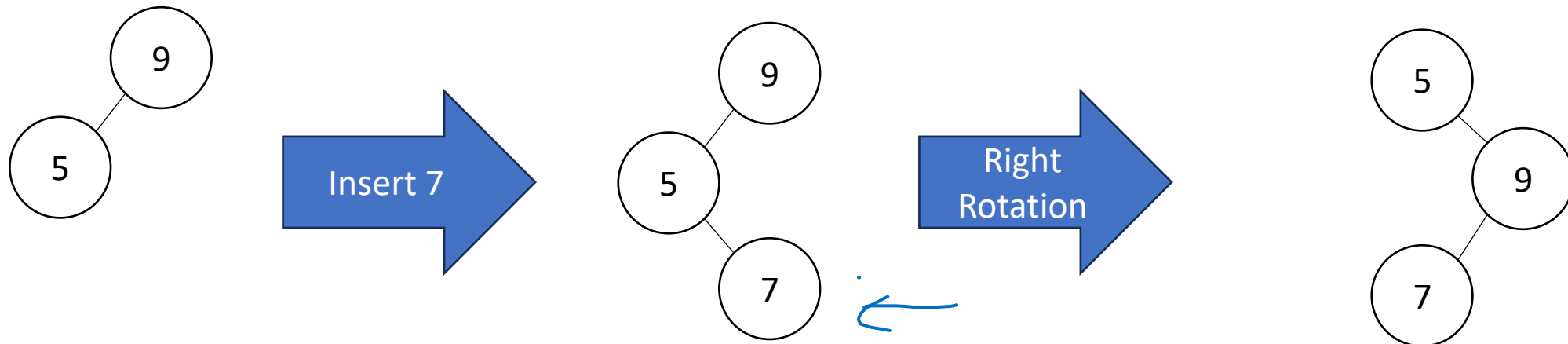

Insertion Story So Far

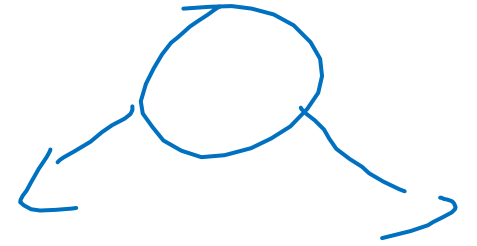

- After ~~insertion~~, update the heights of the node's ancestors
- Check for unbalance
- If unbalanced then at the deepest unbalanced root:
 - Case LL: If we inserted in the **left** subtree of the **left** child then rotate right
 - Case RR: If we inserted in the **right** subtree of the **right** child then rotate left
 - Case LR: If we inserted into the **right** subtree of the **left** child then ???
 - Case RL: If we inserted into the **left** subtree of the **right** child then ???

Cases LR and RL require 2 rotations!

Case LR

- From deepest unbalanced root:
 - Rotate left at the left child
 - Rotate right at the root

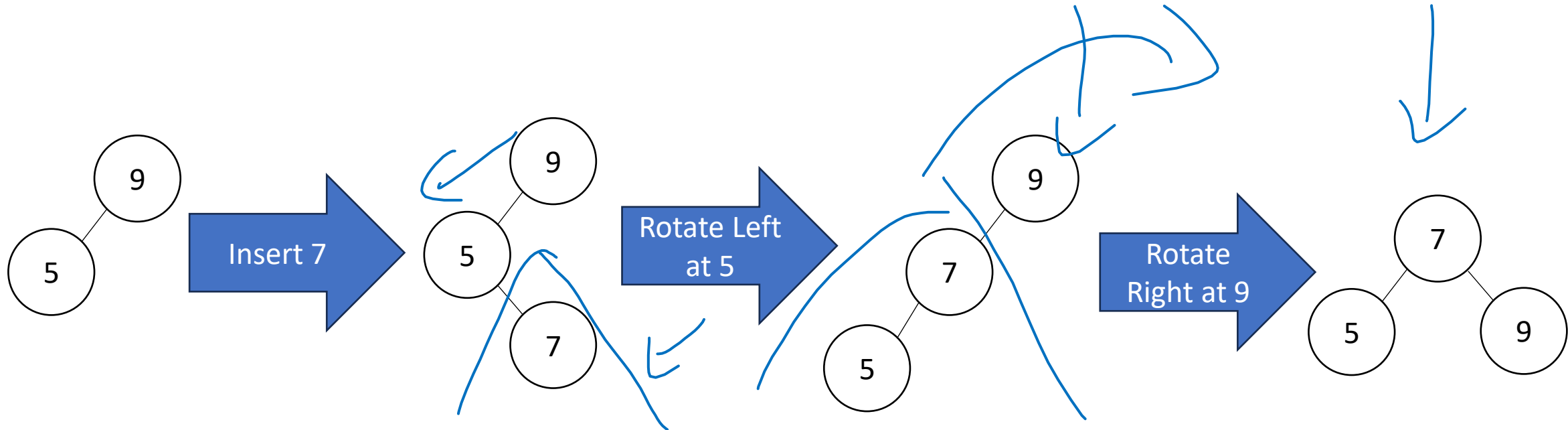

Case LR in General

- Imbalance caused by inserting in the left child's right subtree
- Rotate left at the left child
- Rotate right at the unbalanced node

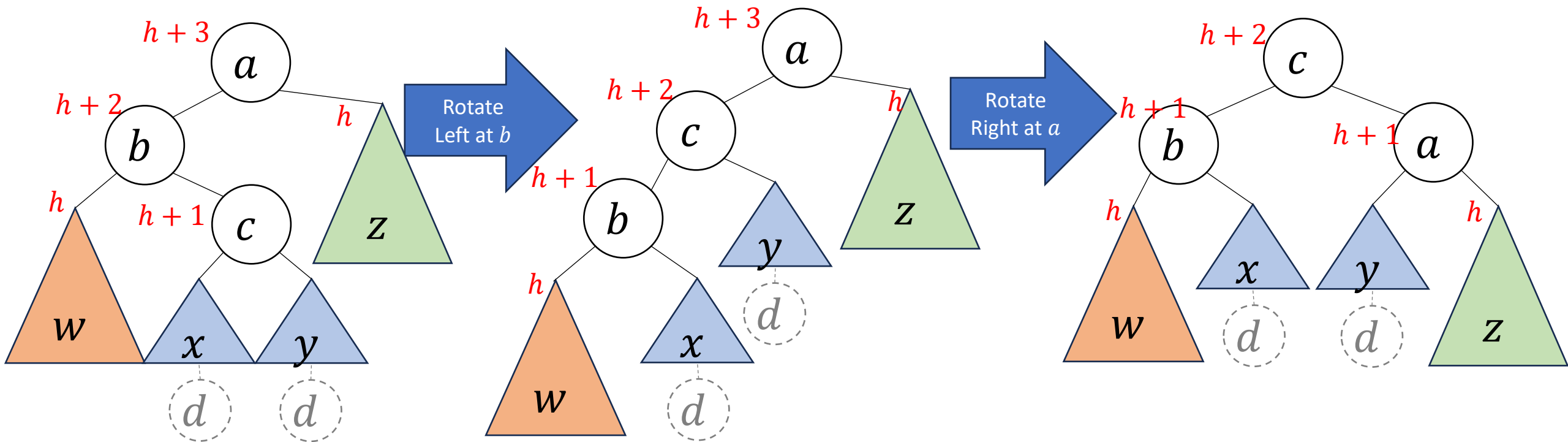

Case RL in General

- Imbalance caused by inserting in the right child's left subtree
- Rotate right at the right child
- Rotate left at the unbalanced node

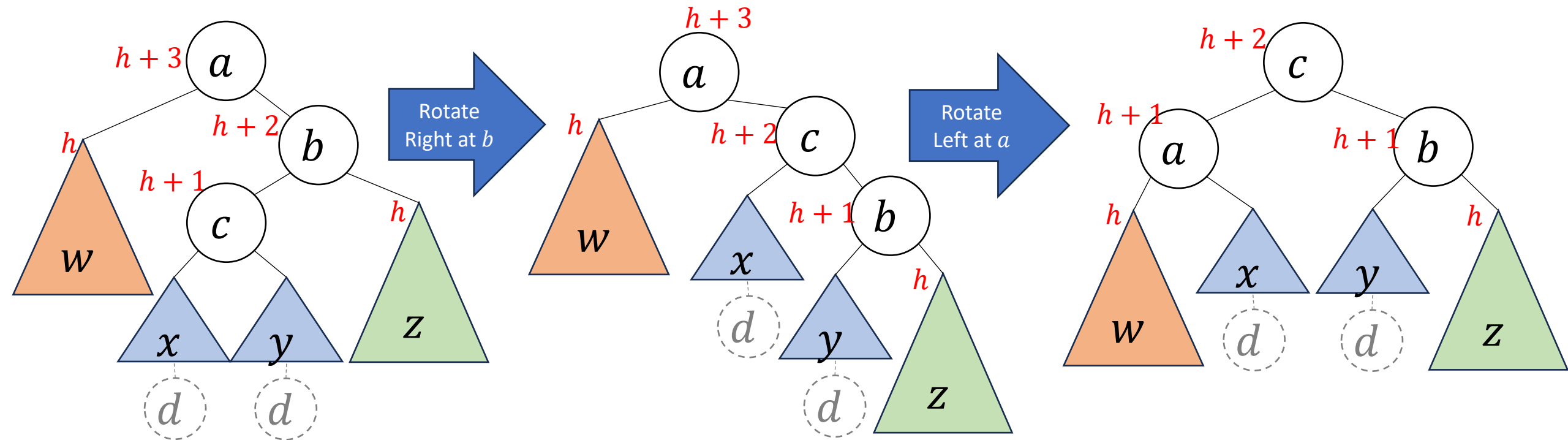

Insert Summary

log n

- After a BST insertion, update the heights of the node's ancestors
- From leaf to root, check if each node is unbalanced
- If a node is unbalanced then at the deepest unbalanced node:
 - Case LL: If we inserted in the **left** subtree of the **left** child then: rotate right
 - Case RR: If we inserted in the **right** subtree of the **right** child then: rotate left
 - Case LR: If we inserted into the **right** subtree of the **left** child then: rotate left at the left child and then rotate right at the root
 - Case RL: If we inserted into the **left** subtree of the **right** child then: rotate right at the right child and then rotate left at the root
- Done after either reaching the root or applying **one** of the above cases

Delete Summary



- Tldr: same cases, reverse direction of rotation, may need to repeat with ancestors
- After a BST deletion, update the heights of the node's ancestors
- From leaf to root, check if each node is unbalanced
- If a node is unbalanced then at the deepest unbalanced node:
 - Case LL: If we deleted in the **left** subtree of the **left** child then: rotate left
 - Case RR: If we deleted in the **right** subtree of the **right** child then: rotate right
 - Case LR: If we deleted into the **right** subtree of the **left** child then: rotate right at the left child and then rotate left at the root
 - Case RL: If we deleted into the **left** subtree of the **right** child then: rotate left at the right child and then rotate right at the root
- Continue checking until reach the root

Memory Hierarchy

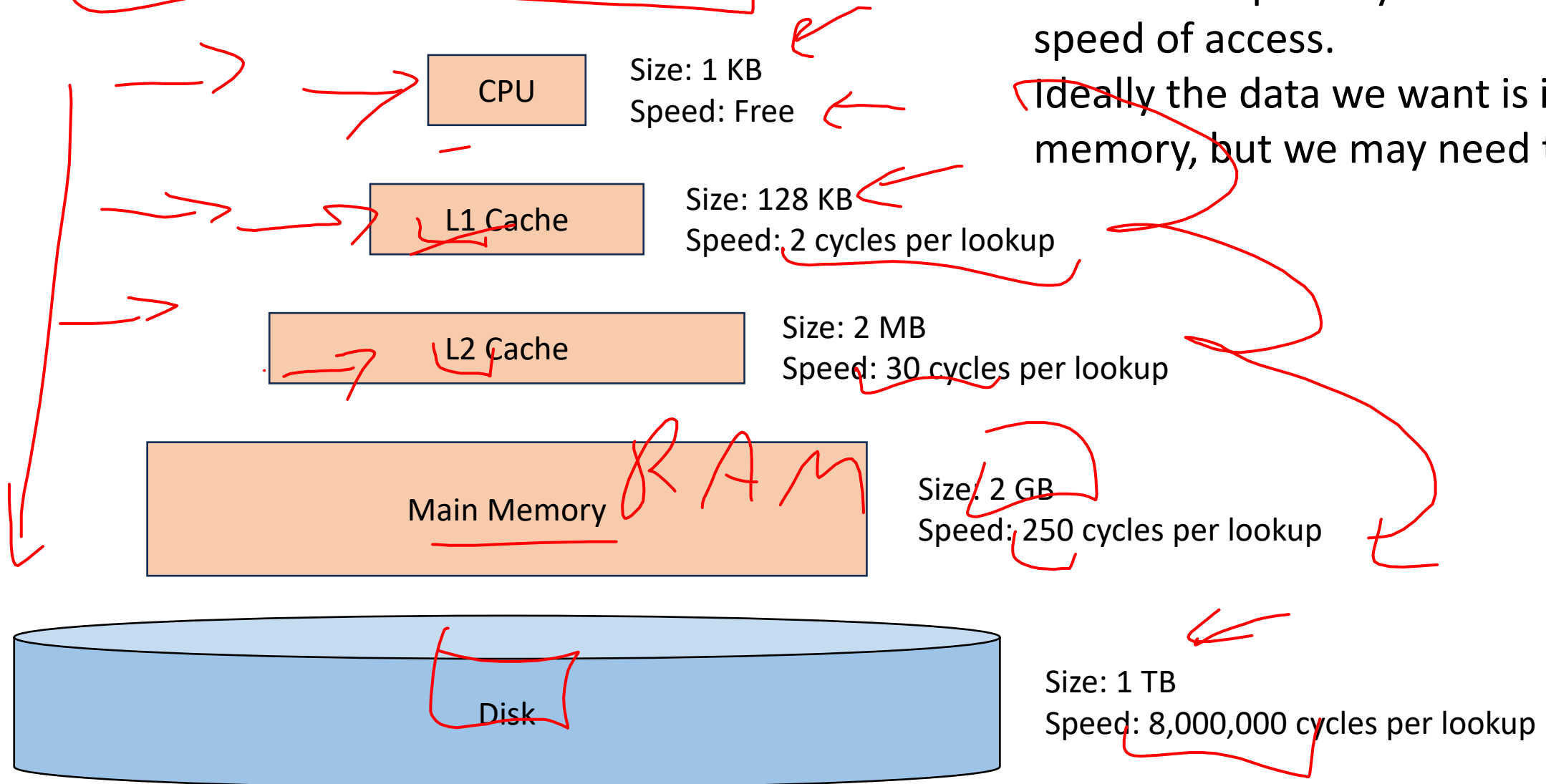

Large memory is slow to access.
We use different “layers” or memory to balance quantity of storage with speed of access.

Ideally the data we want is in small memory, but we may need to go deep

B Trees Motivation

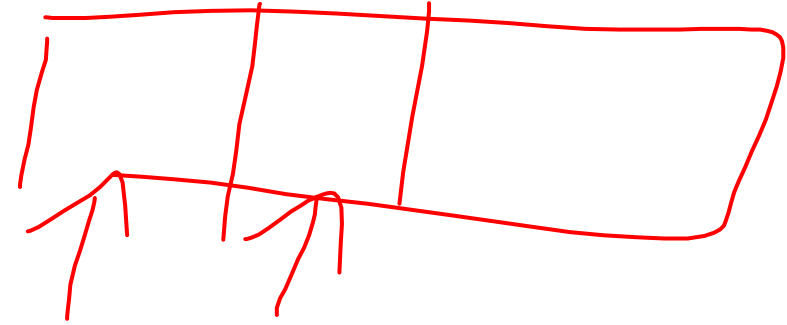

- Memory Locality
 - Observation: in practice, when you read from memory you're likely to soon thereafter read from nearby memory
 - When memory is "fetched", it's collected in blocks at a time
 - Works well for arrays (they're contiguous in memory)
 - May not be helpful for linked lists, BSTs, etc. (pointers could go wherever)
- Solution: Have a BST-like data structure which can take advantage of locality

First Idea

- BST nodes have a lot of information inside them
- We don't need that information for "intermediate" nodes
- Solution: Delay loading anything except keys as long as possible

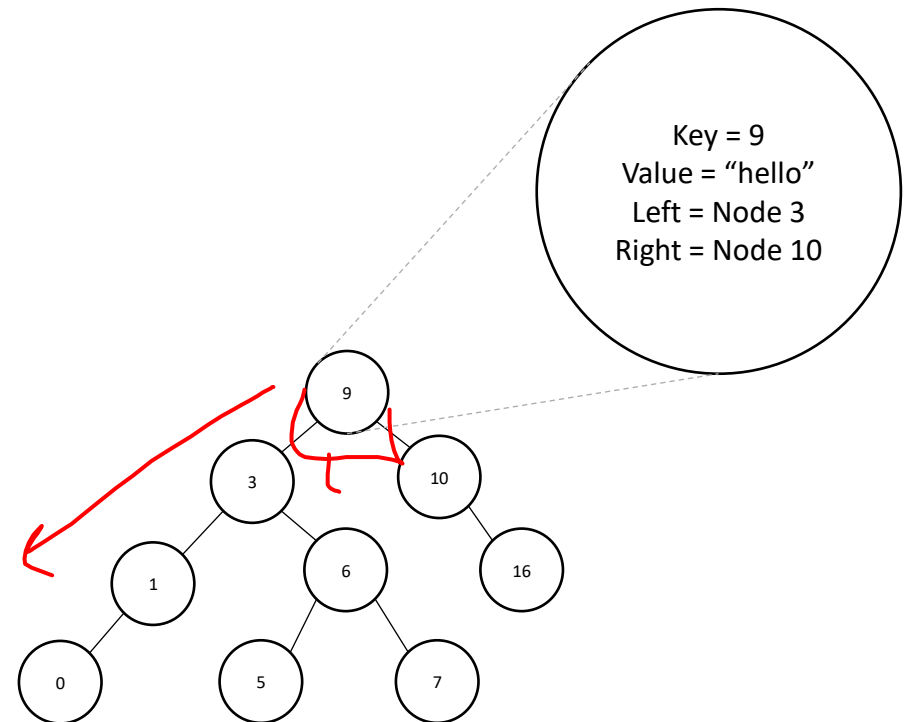

Second Idea

- Nodes may not be close to each other in memory
- In the worst case, each step in a traversal could go deep in memory
- Solution: Increase branching factor of tree load blocks of keys at a time
 - M-ary tree: each node has at most M children
 - Choose M to snugly fit in a block

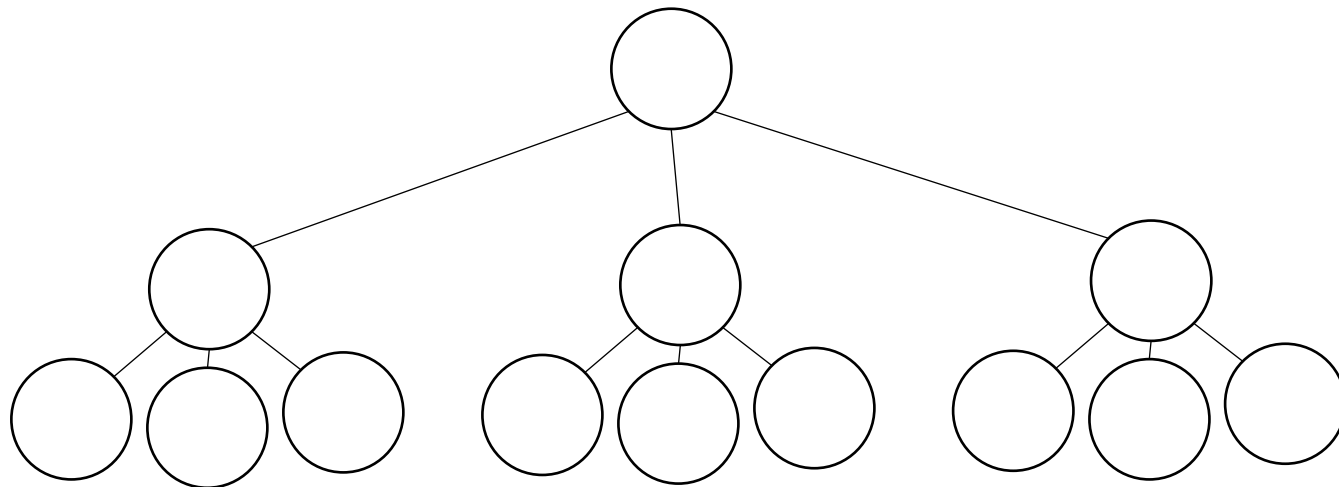

B Trees (aka B+ Trees)

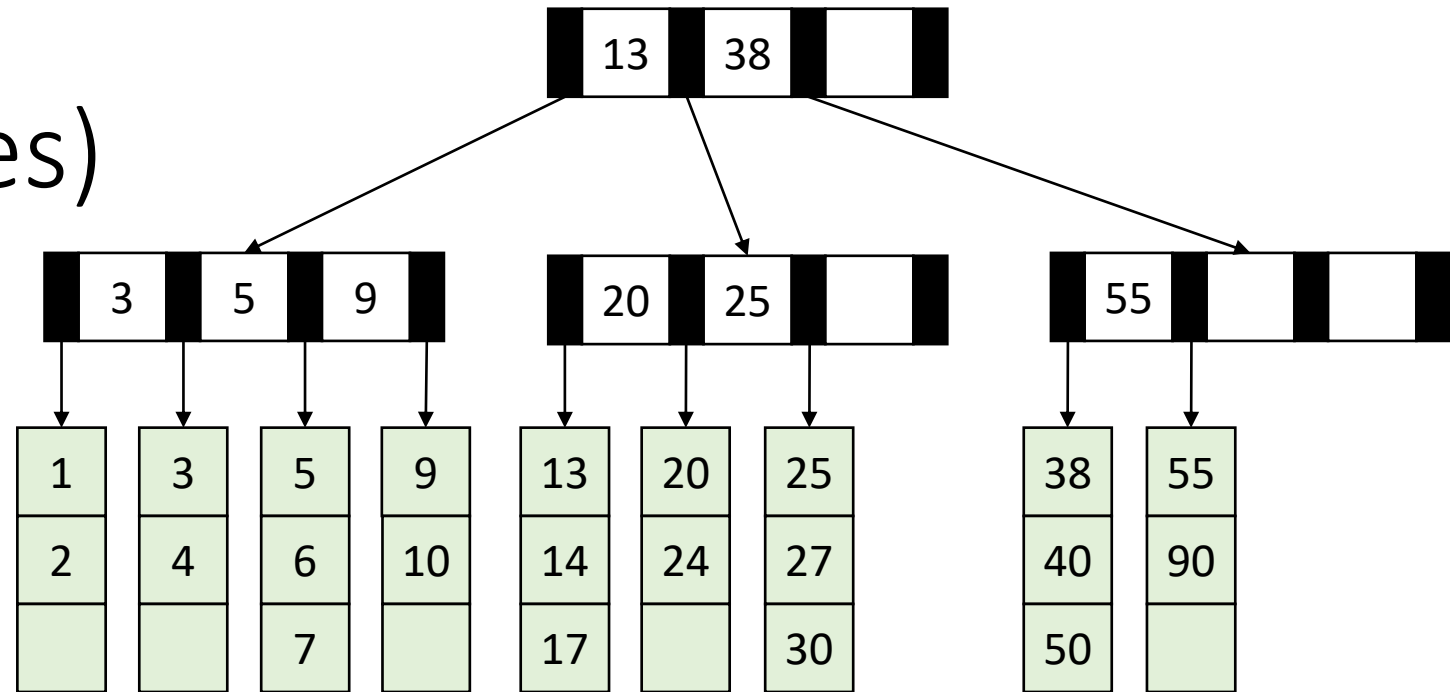

- Two types of nodes:

- Internal Nodes

- Sorted array of $M - 1$ keys
 - Has M children
 - No other data!

- Leaf Nodes

- Sorted array of L key-value pairs

- Subtree between values a and b must contain only keys that are $\geq a$ and $< b$

- If a is missing use $-\infty$
 - If b is missing use ∞

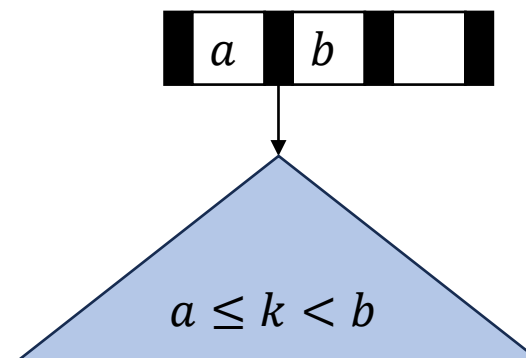

Find

- Start at the root node
- Binary search to identify correct subtree
- Repeat until you reach a leaf node
- Binary search the leaf to get the value

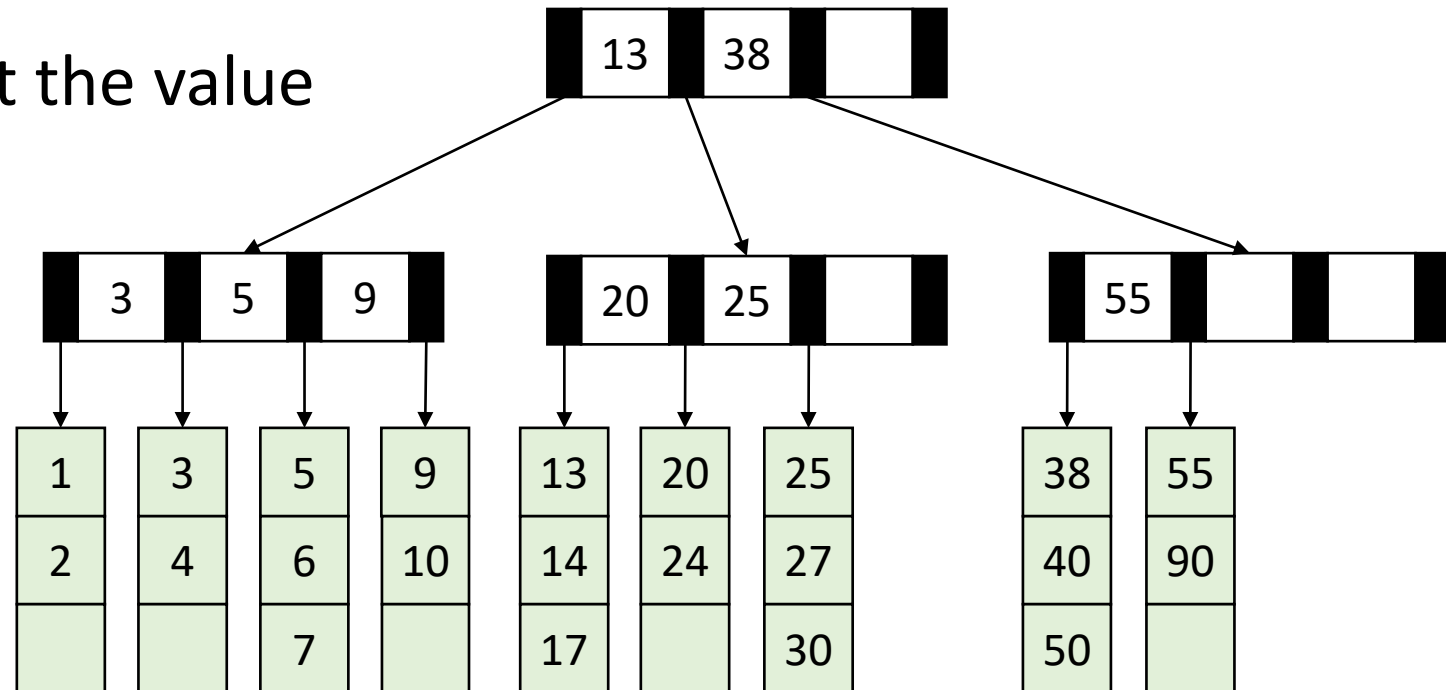

B Tree Structure Requirements

- Root:
 - If the tree has $\leq L$ items then root is a leaf node
 - Otherwise it is an internal node
- Internal Nodes:
 - Must have at least $\lceil \frac{M}{2} \rceil$ children (at least have full)
- Leaf Nodes:
 - Must have at least $\lceil \frac{L}{2} \rceil$ items (at least have full)
 - All leaves are at the same depth

Insertion Summary

- Binary search to find which leaf should contain the new item
- If there's room, add it to the leaf array (maintaining sorted order)
- If there's not room, **split**
 - Make a new leaf node, move the larger half of the items to it
 - If there's room in the parent internal node, add new leaf to it (with new key bound value)
 - If there's not room in the parent internal node, **split** that!
 - Make a new internal node and have it point to the half the leaves (with correct key bound values)
 - If there's room in the parent internal node, add this internal node to it
 - If there's not room, repeat this process until there is!

Insertion TLDR

- Find where the item goes by repeated binary search
- If there's room, just add it
- If there's not room, split things until there is

Insert Example

Insert 22

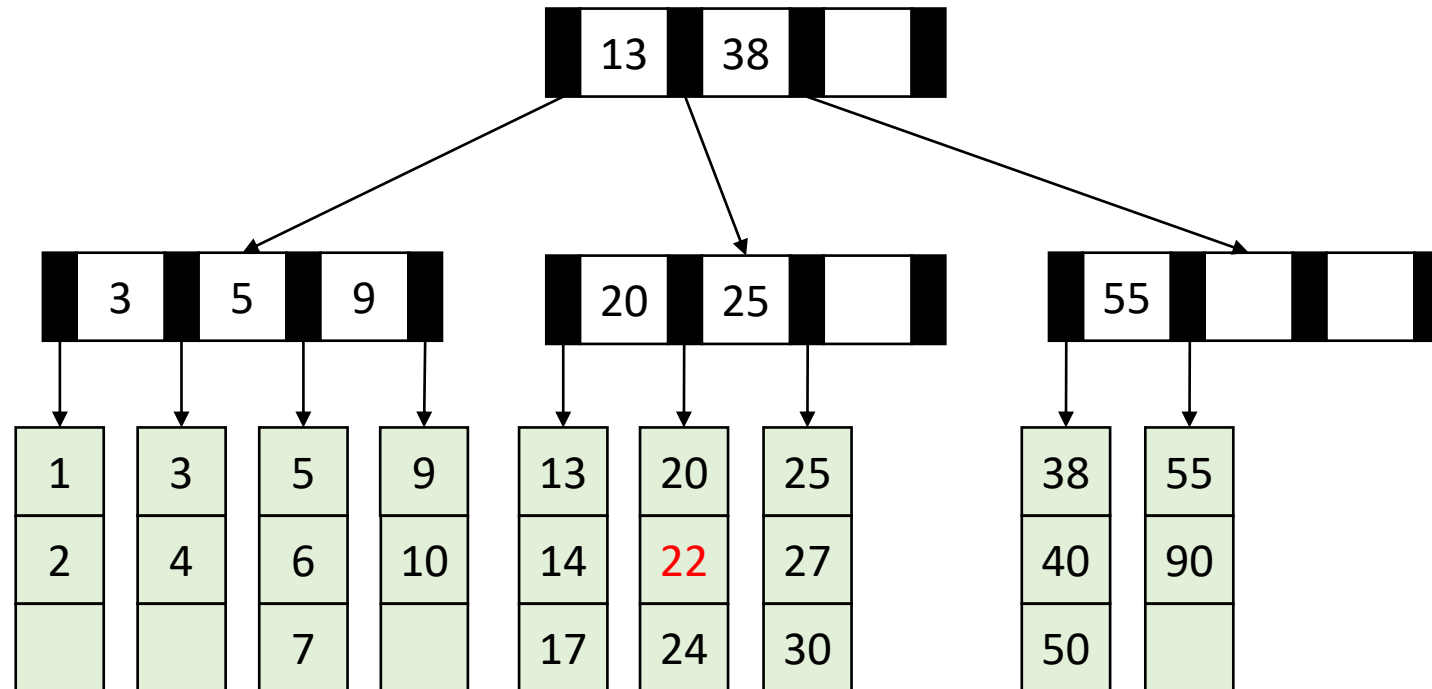

Insert Example

Insert 26

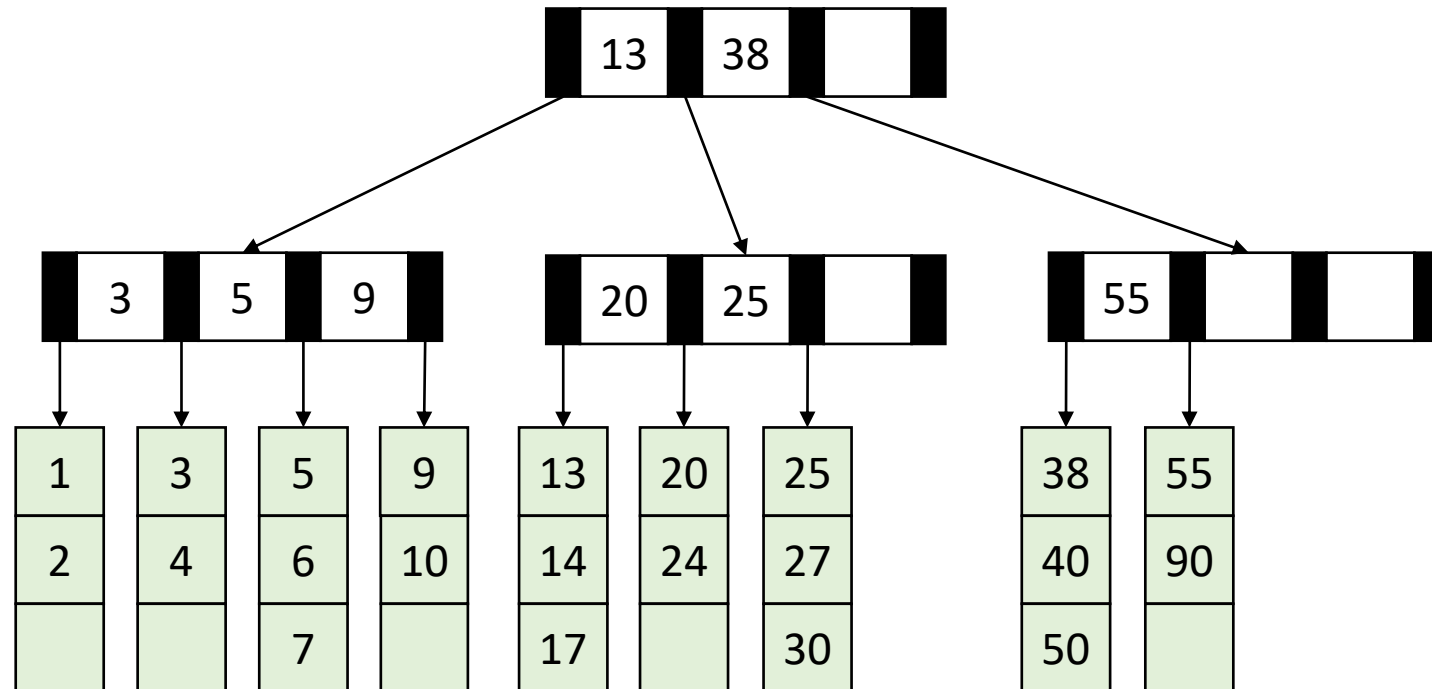

Insert Example

Insert 26

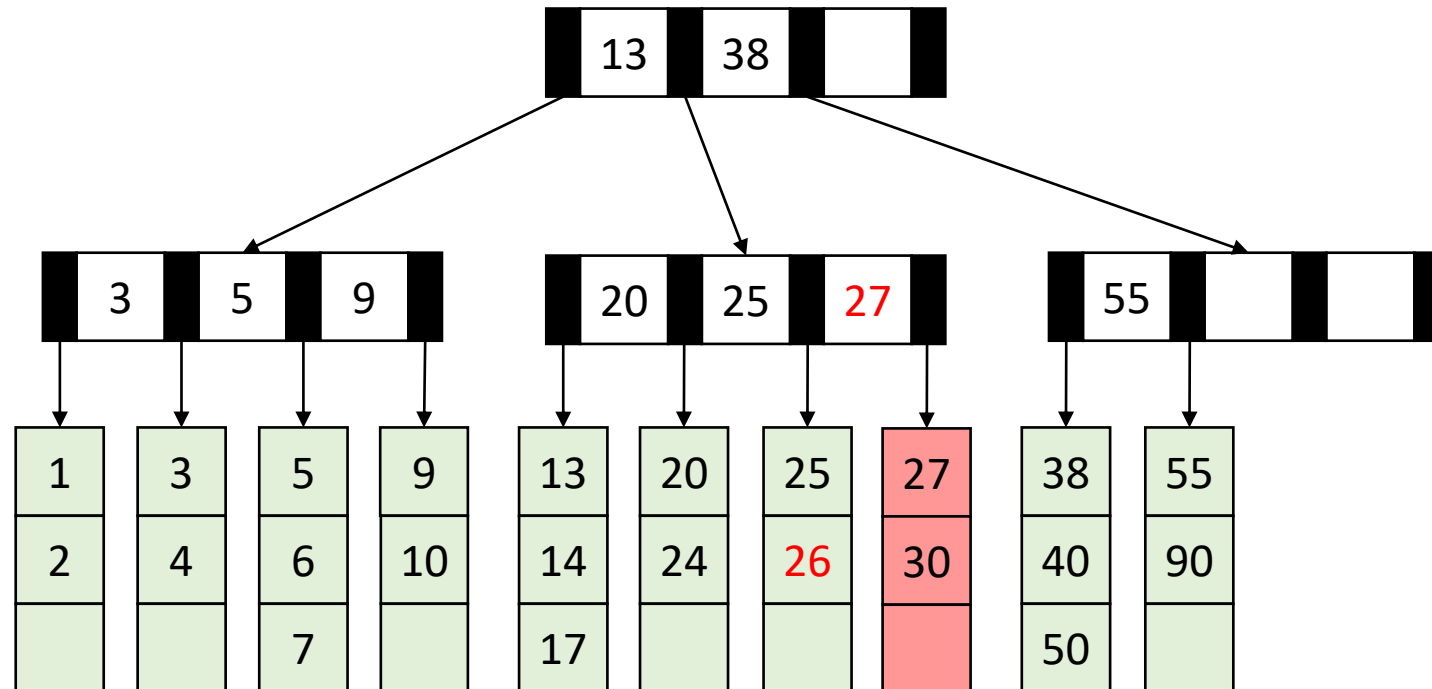

Insert Example

Insert 8

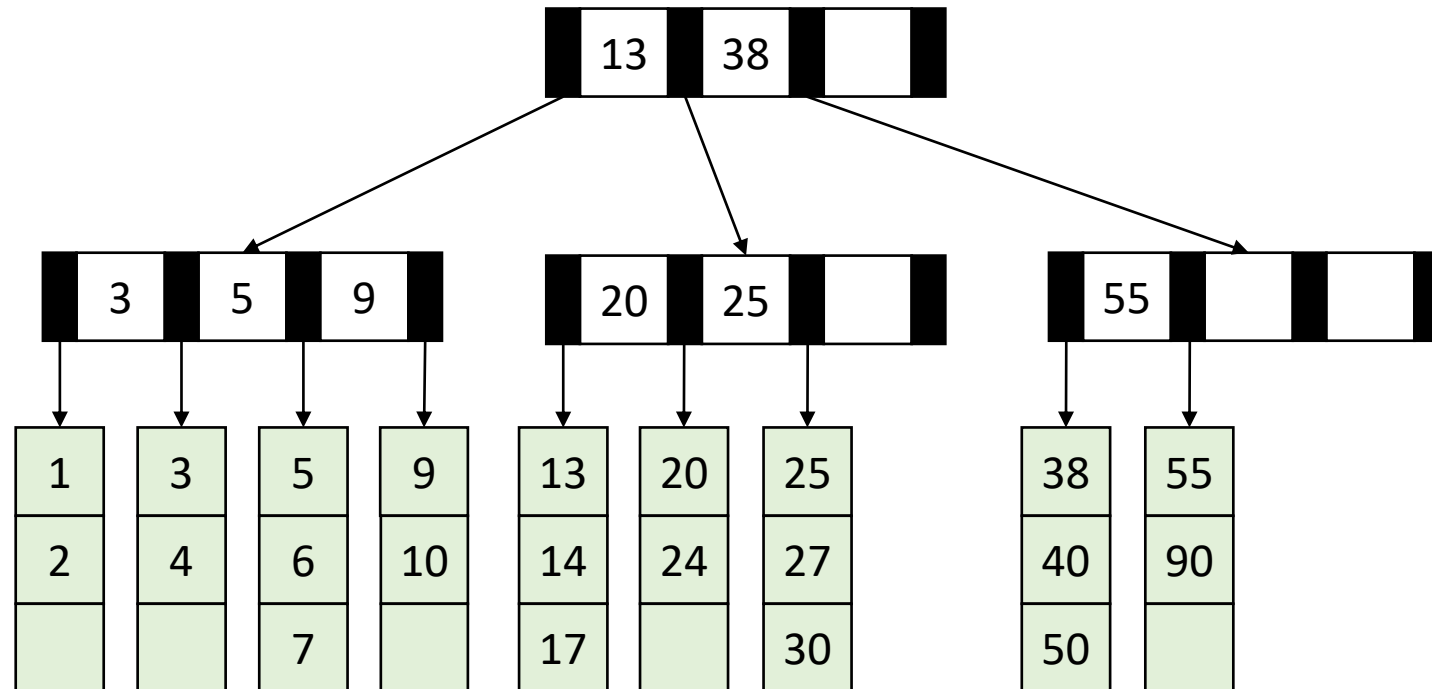

Insert Example

Insert 8

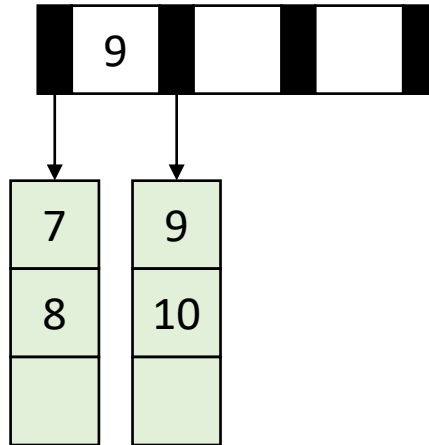
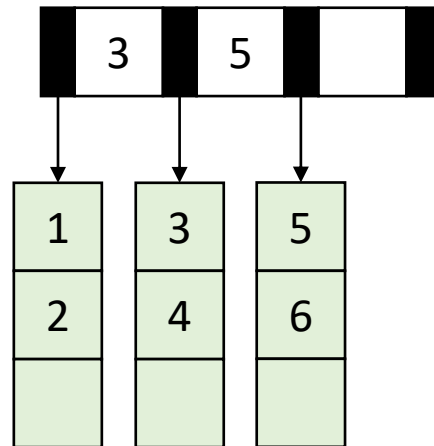
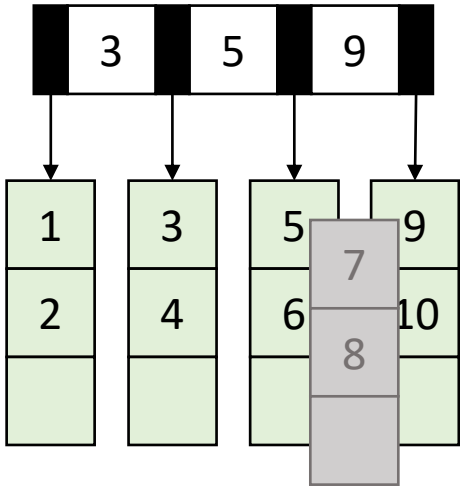
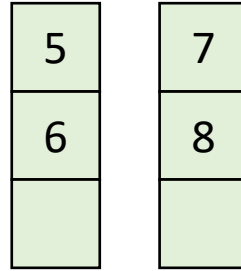
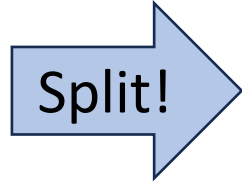
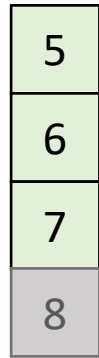

Insert Example

Insert 8

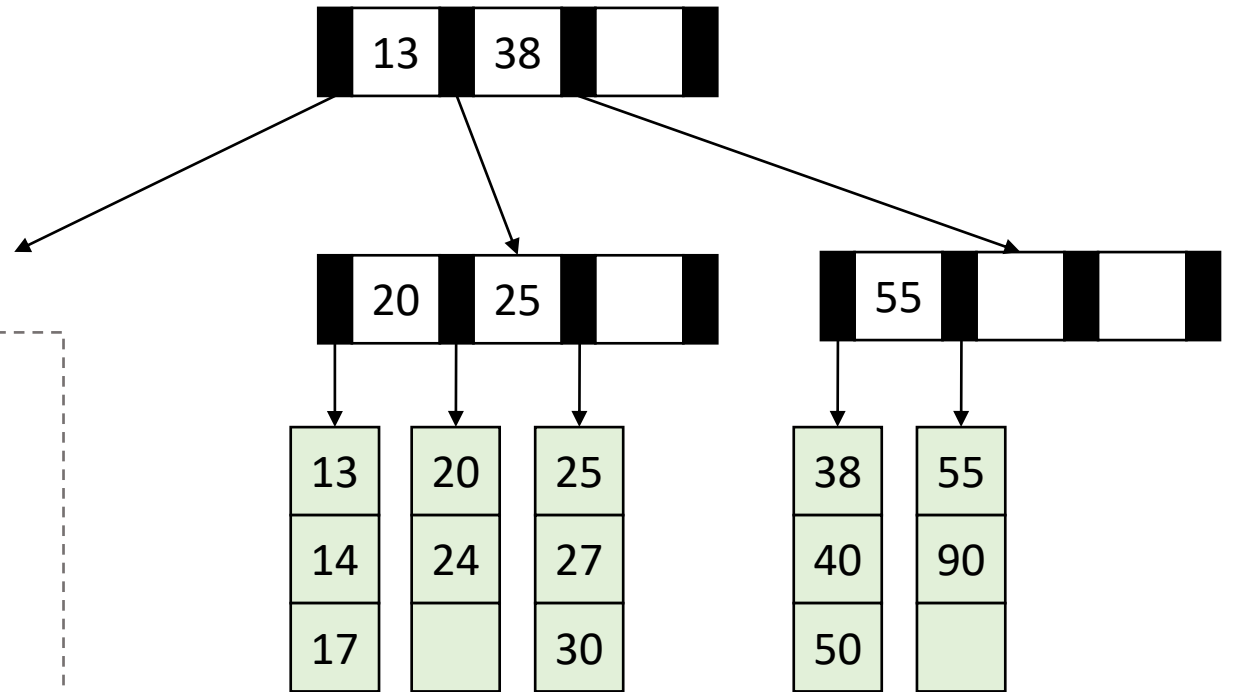
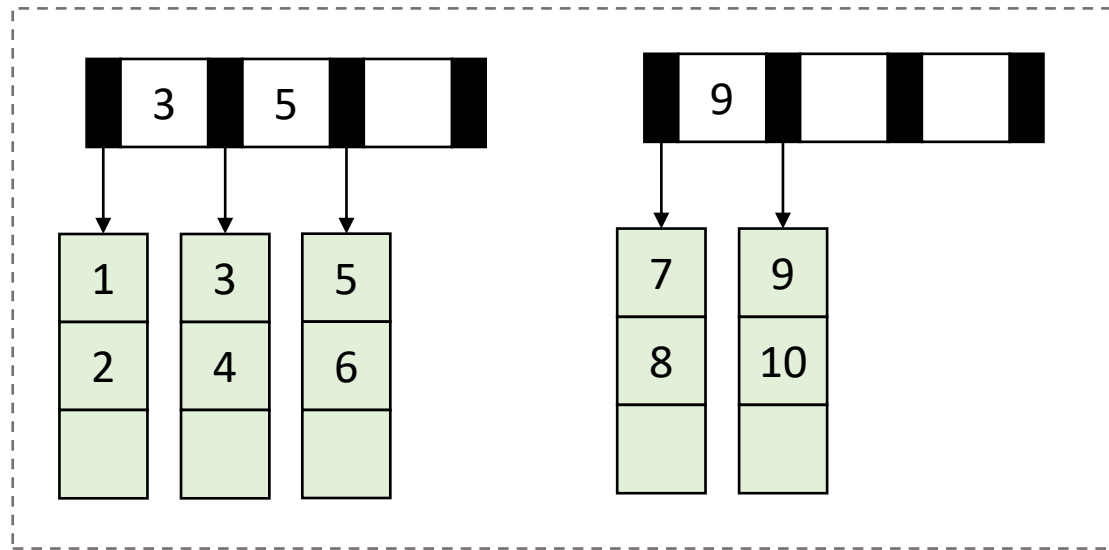

Insert Example

Insert 8

