

CSE352 Autumn Lab #1

Logistics / Constructing Simple Logic Circuits

September 30, 2014

1 Instructions

Read the whole lab first before starting on any work. **You are to complete this lab individually.** You may collaborate with your peers but must turn in your own work. (Download the PDF file rather than using web-based PDF reader, because it may not show the url link which is highlighted by blue color). There are some commentsinsidethetutorial -0.pdf.pleaseclickitandreadit.



1. You are required to use the components

If you have any questions at any point in the lab, make sure you have read the entire lab thoroughly, and ask a TA if you still cannot find the answer. There are no dumb questions: please ask your TAs if you have any doubt, especially before you try something that might damage any of the expensive hardware that is provided for you!

Labs assigned on week n will be due by the end of the last section of week $n + 1$. This means that by Thursday @ 5:20PM on the week the lab is due, your name must be on the check off list. We highly recommend you start early. Late labs will incur a penalty of 20

2 Lab Objective

This lab starts with the preliminaries; signing out your lab kits and making sure you can log in to the lab computers and start the software you'll be using this quarter. We then introduce you to Altera's Terasic DE1 prototyping board and our primary design tool this quarter - both for schematic entry (drawing circuits) and simulating them (verifying that they will operate correctly when we wire them up) - Aldec's Active-HDL. Both of these components are very important for all future labs so

please pay attention and do not rush through this first lab. Though we typically encourage you to work together, it is recommended you do this lab individually to gain the full benefits of the lab.

In this assignment you will learn how to do both schematic entry and simulation for some basic circuits. As you gain more practice with Active-HDL, we will expect you to use this tool to do a large part of your written assignments throughout the quarter. This means, you will see Active-HDL assignments incorporated into your homework, so don't skimp on these labs, they're important!

By the end of this lab you should feel comfortable entering a schematic for a design, setting up simulation stimuli, and verifying that your circuit is correct. The overall goal for this lab will be to construct a circuit which performs the Boolean logic function you derive. Of course, the circuit will be able to use only the chips provided for you. By the end of this lab you should know how to construct and verify the operation of a small circuit (3-6 logic gates) in both Active-HDL and on your prototyping board using switches and LEDs as I/O devices.

3 Lab Equipment

3.1 Laboratory Design Kits

The design kits contain everything you need to construct most of the circuits assigned to you over the course of the quarter. You are responsible for your lab kit and we expect that you will return the kit in good working order with all pieces intact. This especially applies to the chips, which have very delicate pins that should be inserted and removed from the solder-less bread-board the white rectangle will fill all the holes with extra care.

Your Design Kit contains:

1. [Altera Terasic DE1 Prototyping Board](#)
2. A solder-less breadboard attached to the prototyping board, and the Input/Output Connectors attached to the prototyping board.
3. A power supply, or a USB cable that will be used to power your prototyping board
4. A Logic Probe
5. A Wire Stripper/Cutter
6. Needle-Nosed Pliers
7. [A Set of TTL Logic Chips](#) All of these chips are Dual-In-Line Packages and are compatible with your breadboard. You should have one of each chip on this list except for the 6 x inverter chip which you should have two of.

8. Chip Extractor Tool (This is the tool you should use to evenly remove chips from the breadboard. Don't use your fingers to pry up the chips because it could snap the pins or you could injure yourself on the tips of the pins)

Please make sure all of the above are provided for you in your kit. We will provide additional materials later on in the quarter if they are necessary to complete a lab. We are aware that accidents can happen and the pins on chips may already be weakened from years of use. Typically if you break a pin the chip will be replaced and the damage will be forgiven; however in cases of gross negligence you will have to pay for a replacement. Take care not to short out your board by connecting Ground to Power. This results in a very large current that can quickly destroy the components of the board including the board itself. Finally be careful not to snap off wires inside the I/O connectors or the holes in the solder-less breadboard. Wires are best extracted with the needle-nosed pliers and not your fingers.

3.2 Altera Terasic DE1 Prototyping Board

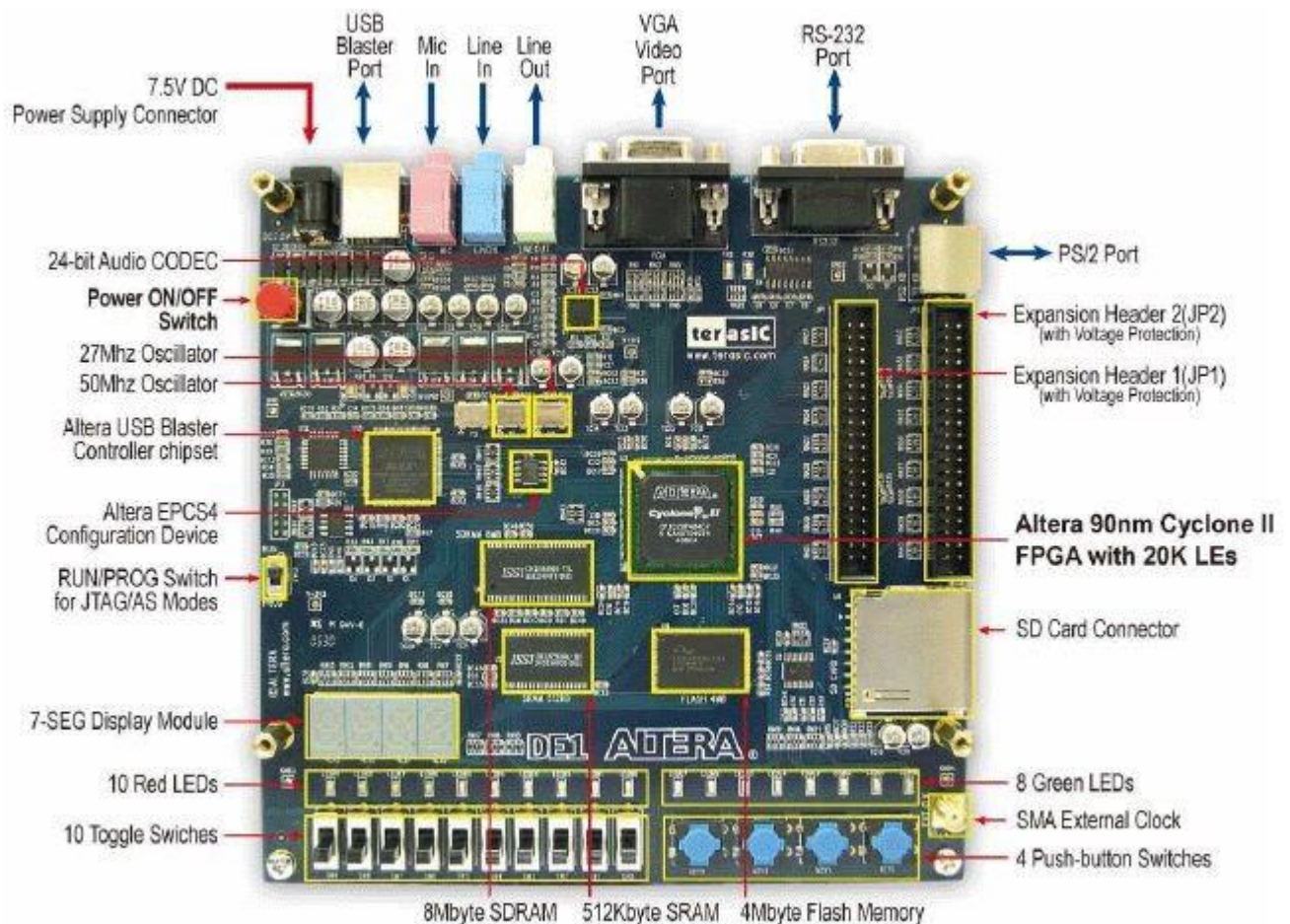

The picture above is a diagram of the prototyping board with most of the major components highlighted. For the first few labs you will be using the various

input/output devices located directly on the board such as the switches and LEDs. Further details will be provided in each lab. Take note of the large FPGA (Field Programmable Gate Array) that is highlighted on the board. Later on in the quarter you will be programming this and directly interfacing with all the devices on the board.

3.2.1 The FPGA

FPGA is short for Field Programmable Gate Array. Essentially it is a large array of logical elements that have been connected together. What makes the FPGA unique is that the connections between these logical elements can be programmed, which means the FPGA can be used to build many different kinds of hardware all on the same chip. If you look at the HEX display on the bottom left hand corner of your DE1 board you will see that it has a scrolling message that says CSE 370. This is a program that the TAs have written and programmed into your FPGA's non-volatile memory. By programming into the non-volatile memory, each time the board is turned on the CSE 370 program will be loaded, regardless of what you did previously.

3.2.2 Switches, Keys, and LEDs

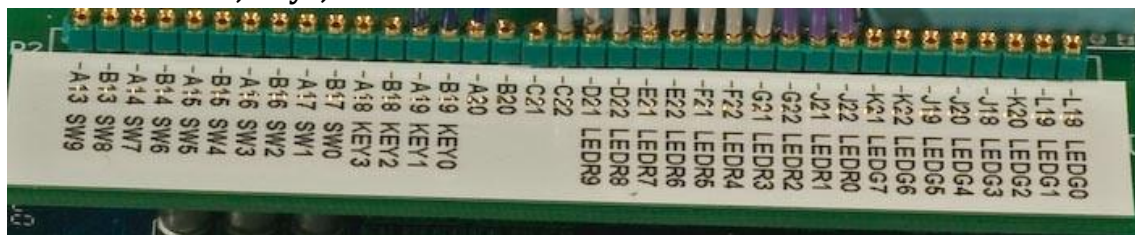

The image is a zoomed-in picture of the connector strip, which gives access to signals on the board. As you can see, each little hole has a corresponding pin mapping (more on this in later labs) and a pre-wired connection to a switch, key or LED on the board. Remember the program that the TA's put in the non-volatile memory mentioned above? Well in addition to having the HEX display scroll CSE 370, the program also wires these holes to the indicated switches, keys, or LEDs. So for example, if you connect the hole labeled "A13 SW9" to the hole labeled "D21 LEDR9" with a wire, you would control the red led labeled LEDR9 on the DE1 board with the switch labeled SW9.

3.2.3 The Solder-Less Bread Board

The solder-less breadboard attached to your prototyping board is where you will be building all of your circuits. Notice the red and black wires going to each of the rows at the top and bottom of the board. The red wire denotes VDD (+5 Volts) and the black wire denotes Ground (0 Volts) we will always use this convention with all our circuits. Never directly connect these two rows together in any way. You should have both a VDD and Ground at the top of your board and a set at the bottom. Even though there

are spaces between the rows, all of the holes are directly connected to each other. This means you have rails of VDD and Ground both at the top and bottom of your board.

In addition to the rails of VDD and Ground provided for you on the board there are 43 columns of holes both above and below an indented divider. All 5 holes in one column are connected; however, the column of 5 holes above the divider is not connected to the column of 5 holes below the divider. All of these connections are internal to the board so you cannot see them. So remember, if you connect VDD into one of the five holes in a column, all five holes now have VDD (+5v) running across them.

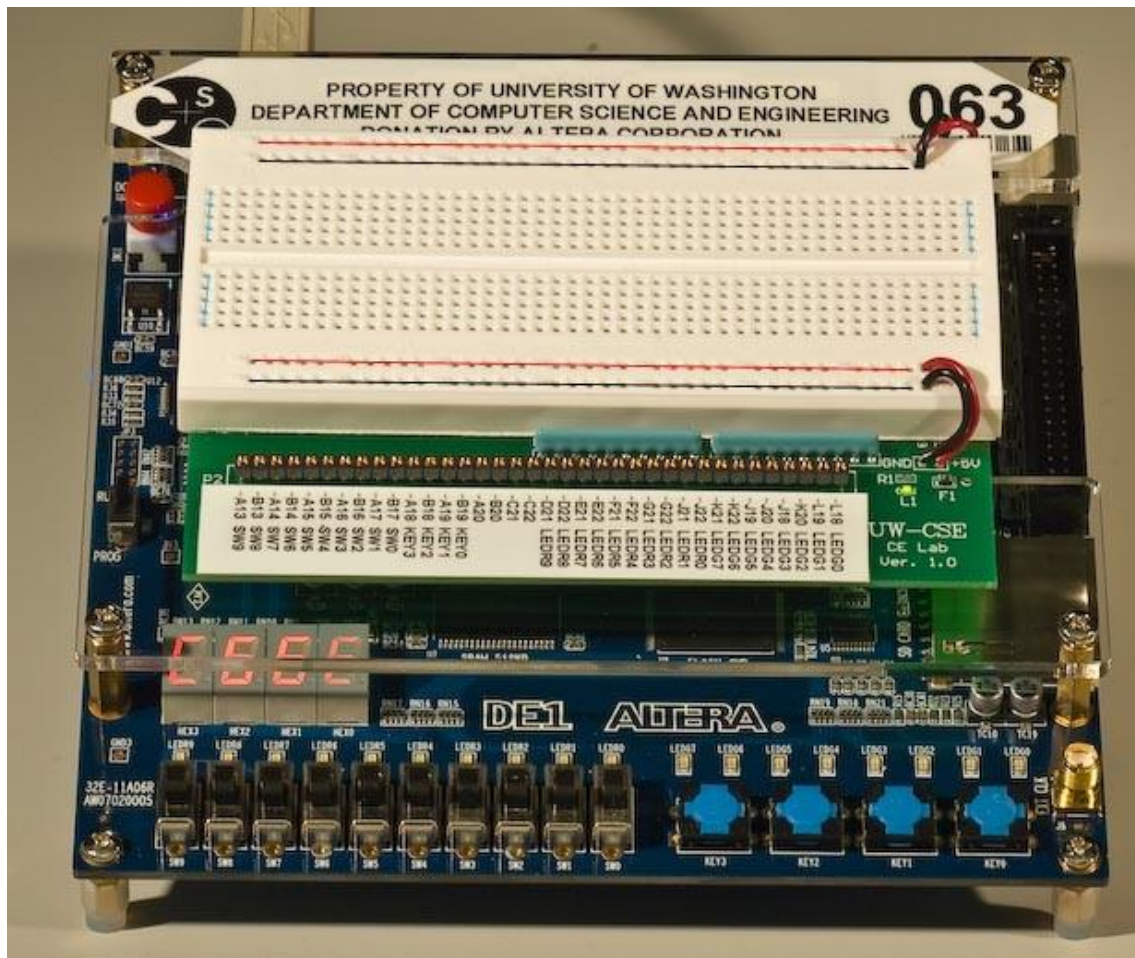

The red line marks where VDD runs across the board, and the black line marks where GND runs across the board. The holes on the board are interconnected as the blue line shows, up-and-down for each 5-hole segment.

Attaching your Solder-Less Bread Board to the Prototyping Board

You will now need to plug the solder-less breadboard into the prototyping board. Turn off the power first! As depicted above, you should plug the bread board connector which is on the bottom of the right-hand side of the bread board circuit into Expansion Header 1 (JP1) (the left one) on the Altera Terasic DE1 Prototyping Board. Make certain that this is properly aligned before you press it in. Note: It is very easy

to mis-align the connectors by one pin from front to back. To make sure that everything is properly aligned, take a look from the side at how the pins from the bread board meet the Expansion Header. They should be entirely within the outer edge of the Expansion Header. If everything is correctly aligned the green LED on the breadboard should light up.

Wiring your Solder-Less Bread Board

Make sure that ends of your wires have the right amount of bare wire (3/8 to 1/2 inch) and that it is straight and without any nicks. If in doubt, cut off the end and re-strip the wire end, making sure to use the right hole of the wire stripper so you don't nick the wire, which can lead to the wire breaking off in the breadboard. Wires should be inserted as perpendicular as possible to the breadboard and should slide in and out with just a little force. If you find that there is a lot of resistance in either direction, first review the wiring guidelines below, and if that doesn't work, then please call over the TA or one of the lab staff.

Do not try to force anything larger than stripped wires into the holes, because this could damage the breadboard (at great cost). If you need more wire help yourself to the provided spools of uncut wire at the front of the lab.

Before doing any work on the breadboard such as wiring and inserting/removing chips, be sure the power is OFF. That is, unplug the power connector while you are constructing the circuit. After you have finished wiring up your design and before you turn on the power, double check the power and ground connections. **Wiring Guidelines**

Wiring your circuit together can often feel tedious, especially in the beginning. However, if you are patient and wire your circuit nicely, you will find that you will spend a lot less time tracking down wiring errors. To aid you in this, here are a few tips to consider while wiring up your circuit. If anything is unclear, ask your TA for an example.

1. Make sure your wires are stripped nicely. This means that when you put the wire in your breadboard, there shouldn't be any un-insulated wire visible and the wire shouldn't crunch against the bottom of the board.
2. Your wires should always be nice and straight; there should be no twists or kinks in it, as they can cause your board to short out when you insert them in your breadboard.
3. Arrange the chips on the breadboard so that only short wire connections are needed. Put tightly connected chips closer together. Chips will only fit with one set of pins on one side of the center divider and another set of pins on the other side of the divider.
4. Do not make a jungle of wires. Long looping wires that go way into the air are easy to pull out (a hard bug to find later when the circuit doesn't work as intended).

- Try to maintain a low wiring profile so that you can reach the pins of the chips and so the chips can be replaced if necessary. The best connections are those that lie flat on the board. Try to avoid wiring over any chips so that chips can be removed easily and replaced.

For those of you that learn better by seeing, here is a [good wiring](#) example and a [bad wiring](#) example.

3.3 Using the Logic Probe

The logic probe provides a very convenient way to check the value of any signal in your circuit. The probe has two lights, HI and LO, which indicate the value of the signal. The logic probe responds to the input voltage in two ways depending on whether CMOS or TTL is selected. We will use the TTL setting which lights the LO (Logical 0) light for voltages $<0.8\text{v}$. and lights the HI (Logical 1) light for voltages $>2.3\text{v}$. If neither light is lit, then the signal is floating (i.e. not being driven by any active output) or has some value between 0.8 and 2.3v.

4 Laboratory Procedures

4.1 Duplicating NOT Gate Behavior

Read This, this can simplify later labs. Now that you have begun to use NOT and NOR gates, did you know there are ways to duplicate the behavior of a NOT gate with a NOR or NAND gate? Consider the two logic tables below: Notice what happens when drive both the inputs of a NOR gate with the same output, it acts like a NOT gate. The same applies for an NAND gate, when you drive both of the inputs of a NAND gate with the same signal it acts like a NOT gate as well. Now if you are short an inverter, but you have NANDs and NORs on your prototyping board you can use them instead for a NOT gate instead of digging out your other NOT chip.

NOT GATE

A	B	Result
0	N/A	1
1	N/A	0

NOR GATE

A	B	Result
0	0	1
0	1	0
1	0	0
1	1	0

NAND GATE

A	B	Result
0	0	1
0	1	1
1	0	1
1	1	0

4.2 Assigned Tasks

1. Check out a lab kit from the TAs. Make sure it includes all the parts listed above and you either have some wires already in the kit or know where you can get wires in 003. If you are missing some of the parts, please ask one of the TAs and we will give you one.
2. Log in to one of the lab computers. Let the TAs know immediately if you have any problem doing this as we want to make sure it is corrected ASAP.
3. Once you are logged in, find the program Active-HDL. Start-it up and make sure you see this sequence of screens (Click on a thumbnail to see a larger version of the image).

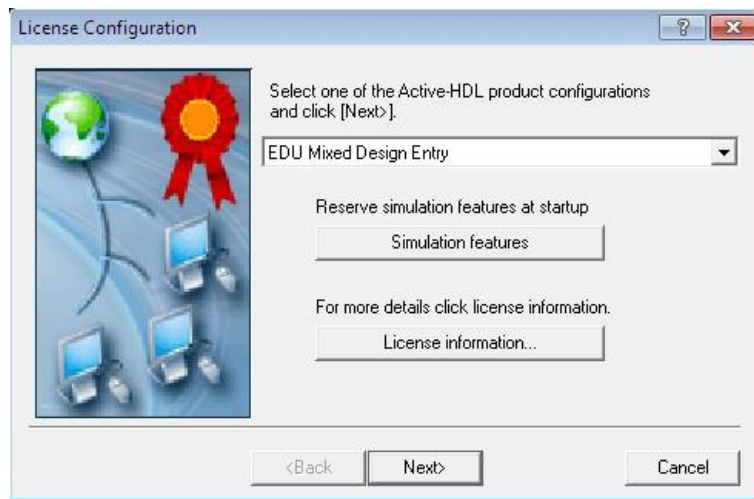

Just Click "Next"



Screen Splash, just ignore it until it goes away

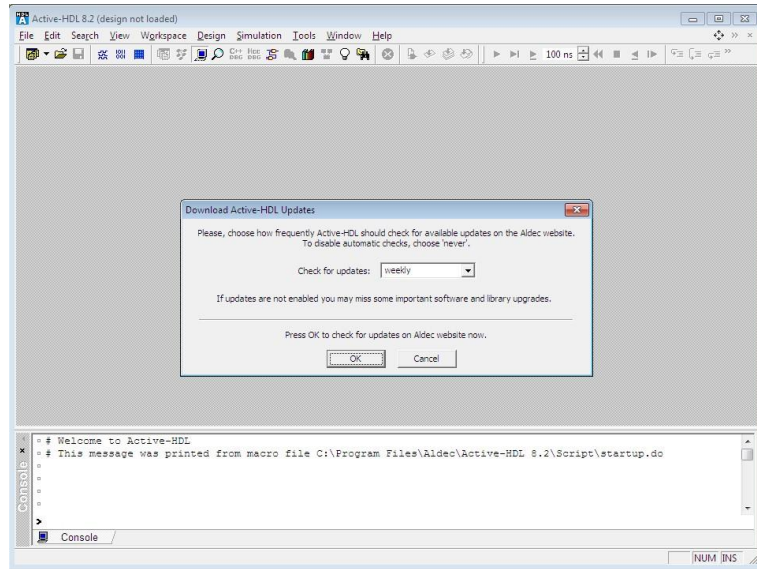

If you get this screen, click cancel. This setting gets reset when you log out.

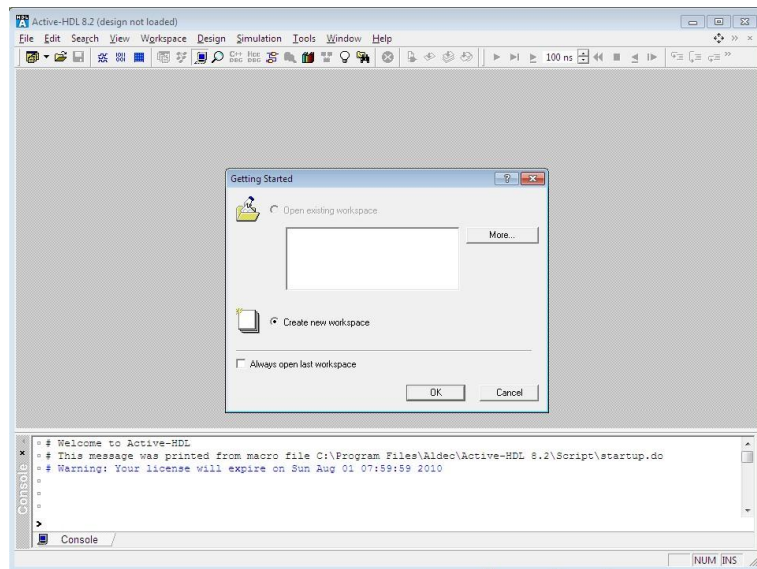

Just click OK

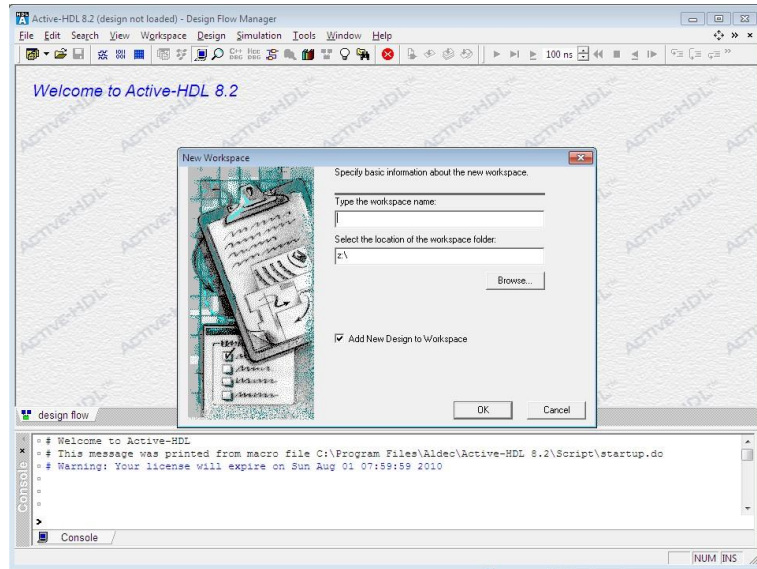

Type in lab0 for the workspace name and then click OK.

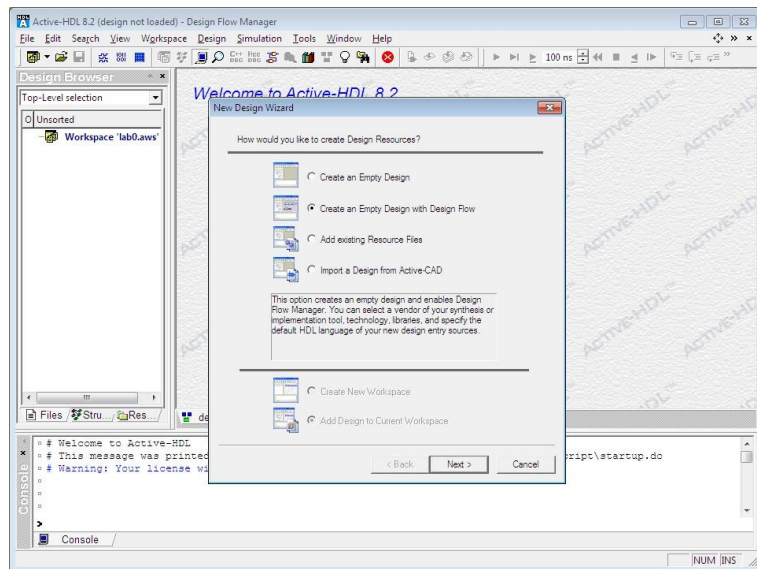

Just click Next again

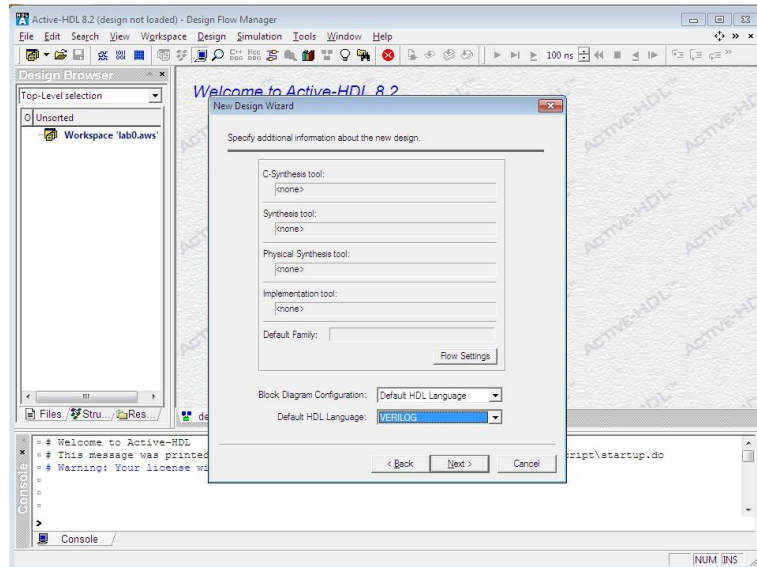

Make sure the Default HDL Language is set to Verilog (it may start up with VHDL).
Click Next.

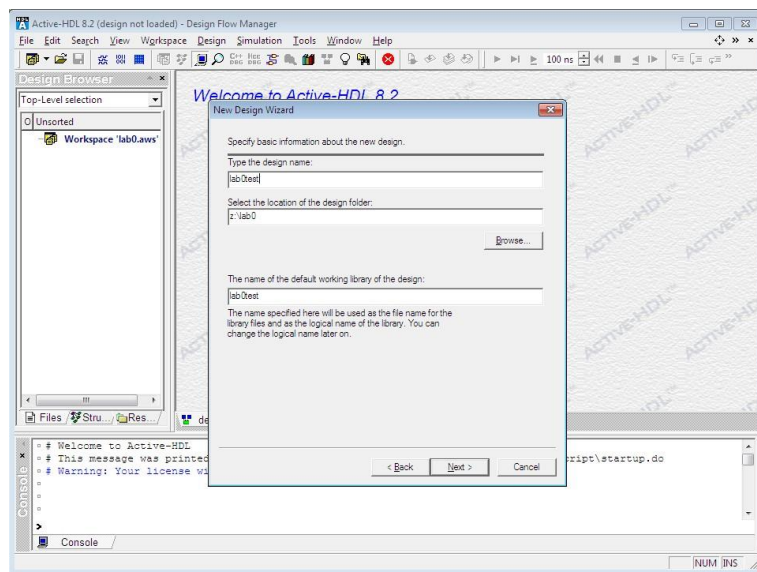

Type in lab0test (make sure not to use any punctuation in the name) for the
design name and then click Next.

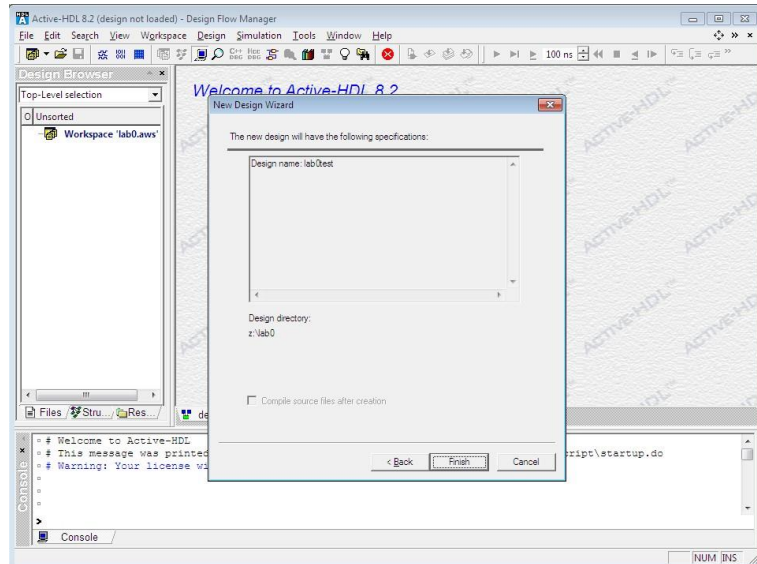

Just click Finish.

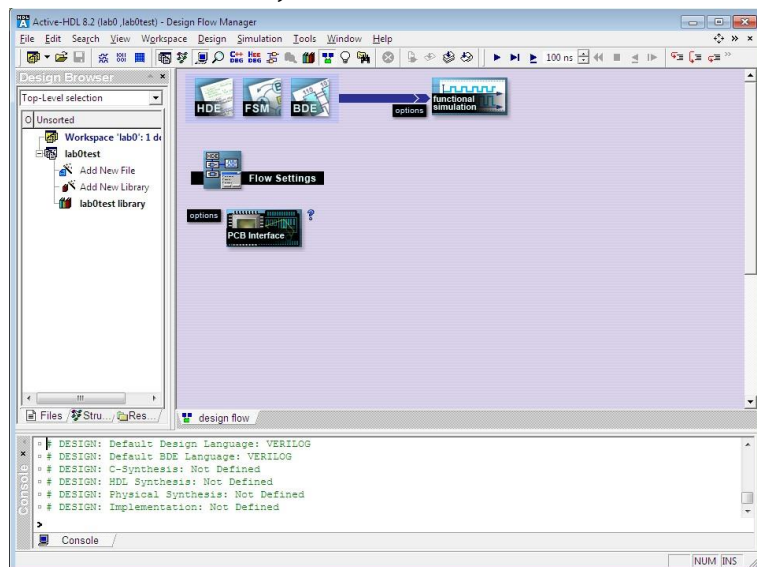

You've successfully started up the Aldec tool if you've reached this point. You can now quit Active-HDL.

- Download the [lib370.zip file](#) , and extract it to your Z: drive. You'll need to add "LIB370" to your Active-HDL library during the tutorial. Note that we ask you to store your files on your own space on the Z: drive because the lab machines are returned to a pristine state after every user logs out. Make sure to not store any files you care about locally they will be lost, and always log out when you leave the lab.

Once Active-HDL is open and you have created your first workspace/design, click on the library button, then click the "Attach Library" button. Finally, go to where you extracted lib370.lib and select it.

5. Complete the [introductory tutorial](#) to Aldec's Active-HDL 6.2. The version is slightly older, but the software has remained very much the same. Ask your TAs if you have any questions about any of the steps in the tutorial. At the end of the tutorial you should have a "Block Diagram Schematic" with an AND and OR gate from the "lib370" part library and simulated the circuit for all possible values. Your TA will need to check-off this waveform, so leave it open or save it somewhere.
6. Use your logic probe to determine in which position the switches provide a 0 or 1.

To use your Logic Probe it first needs power. Make sure your DE1 Prototyping board is off and plug a red wire into one of the VDD rails, then plug a black wire into one of the Ground rails. Remember, these rails are located at the top and bottom of your board (Red is VDD and Black is Ground, but you can verify which rail is which by looking at the color of the wire connected to the rail). Be Careful that you never let a wire connected to VDD touch a wire connected to Ground or you will short out your board. If that ever happens, or you smell odor/see smoke, turn off your DE1 board immediately and pull the power.

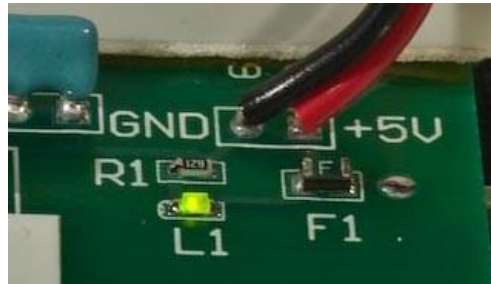

There is a fuse and an indicator light on your prototyping board. If you do accidentally wire up GND to VDD, you will mostly likely blow the fuse "F1" and the light "L1" will go off.

We will now use the logic probe to determine the value of a switch. Power up your Logic Probe by connecting the red clip to the red wire you plugged into VDD, and the black clip to the black wire you plugged into Ground. Make sure the Logic Probe is set to use TTL.

Connect a wire from the hole that corresponds with a switch to a 5-hole column on your breadboard. Now that 5-hole column is connected to the switch, plug another wire into the same 5-hole column; this will be your test wire. Usually you can just press the logic probe gently against the holes to read a value, but it is often more accurate to use a test wire.

Turn on the power now and check the value on your test wire by pressing the tip of the logic probe to the exposed wire. The plastic insulation on the outside won't give you a value, you need to touch metal to metal. If your logic probe

doesn't respond, make sure you're connected VDD and Ground properly on the logic probe and you didn't make any wiring mistakes. Your Logic Probe should either light up "HI" or "LO". Flip the switch a few times to check the responsiveness and to make sure you are getting an accurate reading. If you're unsuccessful, call over a TA.

7. Connect a switch to an LED

Make sure to turn off the power before making any connections.

NOTE: You should always remove power before making any wiring changes and only reconnect it after you've double-checked that you've wired things correctly.

8. Place an inverter (NOT gate) between the switch and LED.

This is your very first chip. We refer to the chip packages by the last two or three numbers in the long string of characters printed on the top of the chip. Find the '04 inverter packaged chip and insert it into the empty region straddling the divider on the breadboard. Each pin of the chip is now connected to a 5-hole column on the breadboard. Be sure to wire up VDD and Ground, chips need power in order to function, and if you don't provide them with a ground, they won't function correctly. Make sure you connect the right pins, Ground is pin 7 and VDD is pin 14 on the '04 chip.

The best way to determine the orientation of inputs and outputs for any of the chips we have provided for you is to look at the chip maps. This '04 Chip has 6 inverters in one package, pick one of them to use and hook up the switch's wire to one of the inputs and hook up the output of the chip for that particular input to the LED. Now turn on the power and flip the switch a few times. Does it behave correctly? Does the LED turn on when the switch is "Off" and turn off when the switch is "on"?

Finally, to make sure that inverter is really doing what it is should be doing, turn off the power to the board. Now take the wire that used to go to the LED and wire it to the input of another inverter located on the chip. Now wire the output of that input to the LED. Turn on the board and check to make sure that the inverter is behaving as expected. Is the LED now following the switch? Turning on when the switch is "On" and turning off when the switch is "Off?" It should do that because two NOTs would logically cancel. Make sure to have a TA do a check-off for this stage.

9. Connect a two-input NOR gate to two switches and one LED.

We won't give you detailed explanations on how to do this next task, however you should be able to apply your knowledge from the previous tasks to complete this one. Think about how a NOR gate works and see if you can find

all four combinations. Make sure to have a TA do a check-off for this stage. Finally if you aren't sure which chip is the NOR chip, look at your [chip map](#).

10. At this point, take a few minutes to complete [Tutorial #1 for Aldec's ActiveHDL](#). Make sure to complete the entire tutorial. It is quite long but very informative and thorough. Please remember to create a new design and/or workspace for various class assignments, and remember when you name things, do not start the name with numbers, and don't use spaces or odd characters; stick to letters. This quarter you will be using Active-HDL for both laboratory and written assignments to generate many different schematics. Separating the files into different designs based off the assignment/project will help prevent compiling bugs and help the course staff to diagnose your problem faster.
11. In the textbook Chapter 1, problems 1.3 and 1.4, you are asked to realize a circuit to detect the "Jack of Diamonds". For this lab you will design a circuit to detect the "Ace of Spades" using the encoding scheme below and only the gates that are available in your lab kit. The gates are available for use in your schematics in lib370 as "c74 ". If you don't remember the package number, refer to the lab kit [chip map](#).

Problem 1.3) Encoding for a deck of cards:

The first step to encoding is to determine how many bits we need to encode each piece of data. For a standard deck of cards, we have 13 different values (2, 3, 4, 5, 6, 7, 8, 9, 10, J, Q, K, A). So that means we need at least 4 bits to represent the 13 different values. Since two to the fourth power gives 16, which is more than 13 so 4 bits should be enough. Finally we have 4 different suits, (Clubs, Diamonds, Hearts, and Spades), which means we'll need 2 bits; since two to the second power is 4, to represent the suits. So the value 0 will be assigned to clubs, 1 to diamonds, 2 to hearts, and 3 to spades. This means we'll need a total of 6 bits to encode an entire standard deck of cards.

We'll be using a specific encoding, so make sure you follow it when you do this lab assignment. First off, we won't be using the values of 0, 14, and 15. Finally the encoding will be done in the following order:

V₃V₂ V₁ V₀ S₁ S₀

In general, note that the higher-numbered subscripts denote higher-order (more significant) bits. By convention, bits progress, left to right, from most significant to least significant. So now, the encoding is as follows in table form:

12. Problem 1.4) An Example Encoding

Value/Decimal Value	Binary Encoding
Ace / 1	0001
2 / 2	0010
3 / 3	0011
4 / 4	0100
5 / 5	0101
6 / 6	0110
7 / 7	0111
8 / 8	1000
9 / 9	1001
10 / 10	1010
Jack / 11	1011
Queen / 12	1100
King / 13	1101

Suit/Value	Binary Encoding
Clubs / 0	00
Diamonds / 1	01
Hearts / 2	10
Spades / 3	11

As an example for the encoding above we'll encode Jack of Diamonds. Remember, your assignment is the Ace of Spades, so don't build the Jack of Diamonds! So first off we look at the value of the card, Jack corresponds to the value of 11, which means the encoding for the value should be 1011. Next the suit is Diamond, which means the encoding should be 01. So if we put it all together in the format described above we get: 1011 01. This can be represented as:

V3 and V2' and V1 and V0 and S1' and S0

You will have to design a circuit that will light up a light when the values for the Ace of Spades is entered via the switches, one switch for each bit. Since you have to use only the chips provided make sure your design uses NAND and/or NOR gates since your lab kit does not have AND gates. And remember, the smaller and more efficient the circuit, the easier it is to debug and build!

13. Draw a schematic for your "Ace of Spades" circuit using Active-HDL and the chip parts (parts starting with c74) from the lib370 library. Using stimulators as shown in [Tutorial #1](#) , simulate this circuit for all possible input values, and show that your circuit recognizes the "Ace of Spades". Show your schematic and the result of your simulation to a TA at check-off before you proceed to

Problem 5

step 14. We want to make sure that your logic is correct before you construct the circuit. There is no need to print anything.

Remember: When you are designing this in Active-HDL be sure to use only the 370 parts in the 370 part library. You will always use the 370 part library! Finally make sure you use the right parts, don't use individual logic gates, instead use the chip parts that are included. The library holds virtual copies of the chips that are included in your kit. These begin with C74. When you do this it will make building the circuit much easier because you're using the actual chips instead of broken up gates. Lastly, if you're having trouble with the simulation make sure your chips are powered. They need both a VDD and a Ground in order to function properly, even in simulation!

14. Using your design from task 13 you will need to construct a circuit that will identify the Ace of Spades on the prototyping board by connecting the inputs to switches and a confirmatory output to an LED. Since we use 6 bits to do the encoding you will need 6 switches. Please use SW0 and SW1 for the suit and SW2, SW3, SW4, and SW5 for the value of the card. Remember since the bits work left to right as most significant, SW5 will be V3, SW4 will be V2, SW3 will be V1, and SW2 will be V0. Finally SW1 will be S1 and SW0 will be S0. Demonstrate your circuit to the TA and make sure everything is working properly. You know it's working properly when the LED only comes on when the input for the Ace of Spades is given.

Hints: If you have any problems with your circuit you can trace through your circuit with the logic probe to make sure all the values are what you expect. Since we're allowing you to design your Ace of Spades circuit, you actually have a little bit of free will in terms of how you want your circuit to react. You can choose to make your circuit active high or active low. Active High means the LED will come on when the Ace of Spades input is given by the switches, and Active Low means that the LED is always on and will only turn off when the Ace of Spades input is given. It is up to you how you want to design your circuit, just let your TA know when they check-off your project.

5 Lab Demonstration and Check Off Requirements

A TA needs to "Check Off" the following tasks listed below in order for you to get full credit for the lab:

1. Show your simulation output (Waveform) of the AND and OR gates from Task

-
- 5.
 2. Demonstrate your working NOT or Double NOT gate and NOR gate to your TA from Tasks 8 & 9.

Problem 5

3. Show your schematic and simulation output (Waveform) from Active-HDL from Task13.
4. Demonstrate your working "Ace of Spades" circuit from Task 14.