

## Sequential logic

- Sequential circuits
  - ▮ simple circuits with feedback
  - ▮ latches
  - ▮ edge-triggered flip-flops
- Timing methodologies
  - ▮ cascading flip-flops for proper operation
  - ▮ clock skew
- Asynchronous inputs
  - ▮ metastability and synchronization
- Basic registers
  - ▮ shift registers

CSE 370 - Spring 2000 - Sequential Logic - 1

## Sequential circuits

- Circuits with feedback
  - ▮  $\text{outputs} = f(\text{inputs}, \text{past inputs}, \text{past outputs})$
  - ▮ basis for building "memory" into logic circuits
  - ▮ door combination lock is an example of a sequential circuit
    - ▮ state is memory
    - ▮ state is an "output" and an "input" to combinational logic
    - ▮ combination storage elements are also memory

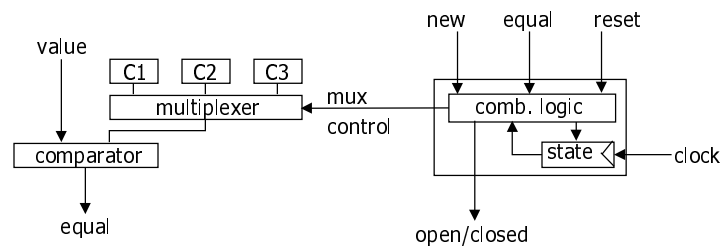

CSE 370 - Spring 2000 - Sequential Logic - 2

## Circuits with feedback

- How to control feedback?
  - what stops values from cycling around endlessly

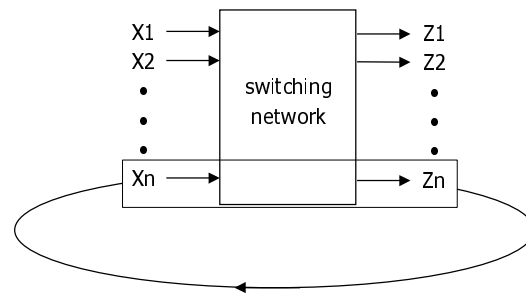

CSE 370 - Spring 2000 - Sequential Logic - 3

## Simplest circuits with feedback

- Two inverters form a static memory cell
  - will hold value as long as it has power applied

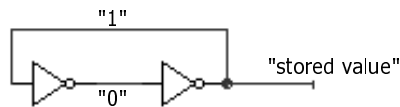

- How to get a new value into the memory cell?
  - selectively break feedback path
  - load new value into cell

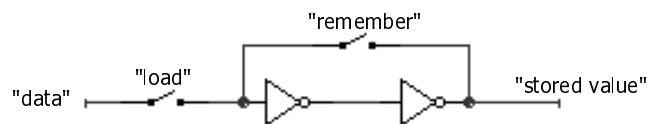

CSE 370 - Spring 2000 - Sequential Logic - 4

# Memory with cross-coupled gates

- Cross-coupled NOR gates
  - similar to inverter pair, with capability to force output to 0 (reset=1) or 1 (set=1)

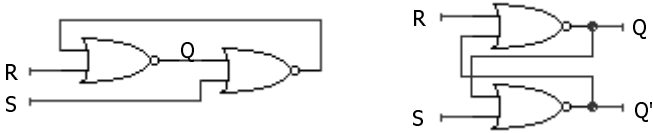

- Cross-coupled NAND gates
  - similar to inverter pair, with capability to force output to 0 (reset=0) or 1 (set=0)

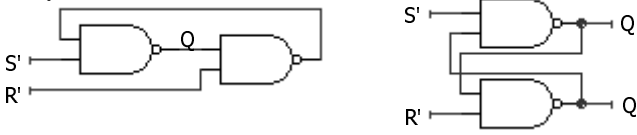

# Timing behavior

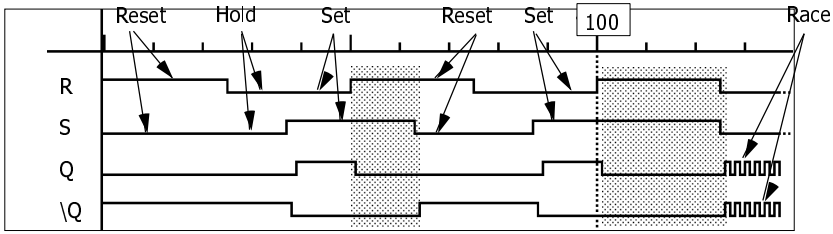
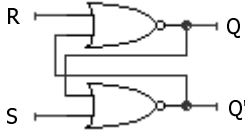

## State behavior or R-S latch

### ■ Truth table of R-S latch behavior

S	R	Q
0	0	hold
0	1	0
1	0	1
1	1	unstable



## Theoretical R-S latch behavior

### ■ State diagram

- states: possible values
- transitions: changes based on inputs

possible oscillation between states 00 and 11

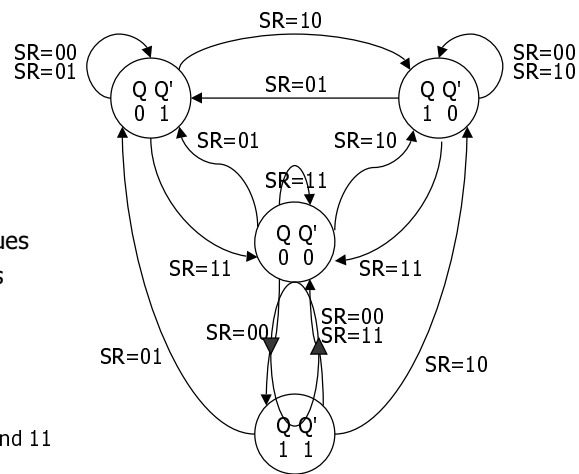

## Observed R-S latch behavior

- Very difficult to observe R-S latch in the 1-1 state
  - ▮ one of R or S usually changes first
- Ambiguously returns to state 0-1 or 1-0
  - ▮ a so-called "race condition"
  - ▮ or non-deterministic transition

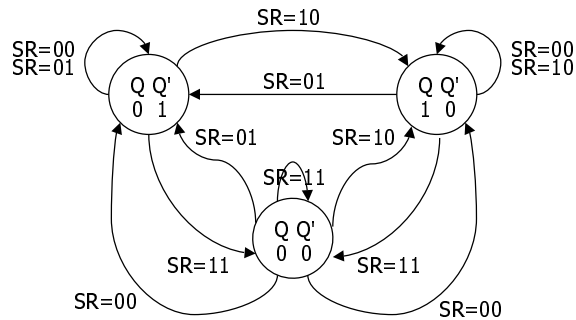

CSE 370 - Spring 2000 - Sequential Logic - 9

## R-S latch analysis

- Break feedback path

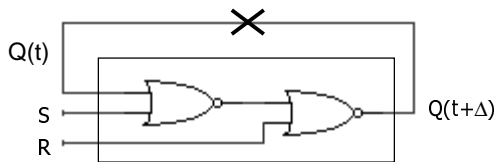
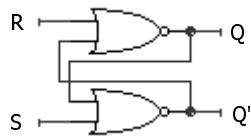

S	R	Q(t)	Q(t+Δ)	
0	0	0	0	hold
0	0	1	1	
0	1	0	0	reset
0	1	1	0	
1	0	0	1	set
1	0	1	1	
1	1	0	X	not allowed
1	1	1	X	

		S	
		0	1
Q(t)	0	0	X
	1	0	X

R

characteristic equation  
 $Q(t+\Delta) = S + R' Q(t)$

CSE 370 - Spring 2000 - Sequential Logic - 10

## Gated R-S latch

- Control when R and S inputs matter
  - otherwise, the slightest glitch on R or S while enable is low could cause change in value stored

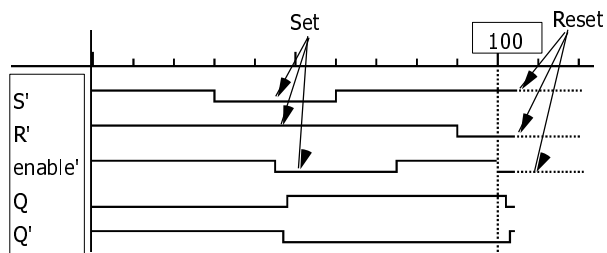
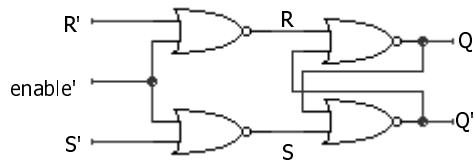

CSE 370 - Spring 2000 - Sequential Logic - 11

## Clocks

- Used to keep time
  - wait long enough for inputs ( $R'$  and  $S'$ ) to settle
  - then allow to have effect on value stored
- Clocks are regular periodic signals
  - period (time between ticks)
  - duty-cycle (time clock is high between ticks - expressed as % of period)

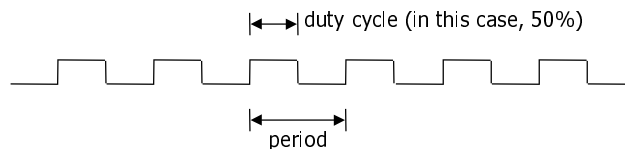

CSE 370 - Spring 2000 - Sequential Logic - 12

## Clocks (cont'd)

- Controlling an R-S latch with a clock
  - can't let R and S change while clock is active (allowing R and S to pass)
  - only have half of clock period for signal changes to propagate
  - signals must be stable for the other half of clock period

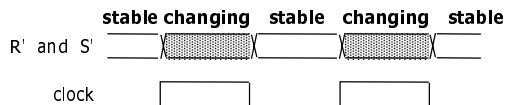
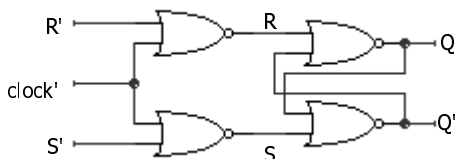

CSE 370 - Spring 2000 - Sequential Logic - 13

## Cascading latches

- Connect output of one latch to input of another
- How to stop changes from racing through chain?
  - need to be able to control flow of data from one latch to the next
  - move one latch per clock period
  - have to worry about logic between latches (arrows) that is too fast

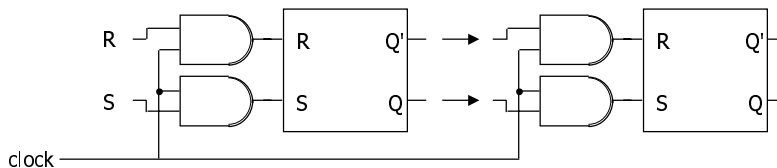

CSE 370 - Spring 2000 - Sequential Logic - 14

## Master-slave structure

- Break flow by alternating clocks (like an air-lock)
  - use positive clock to latch inputs into one R-S latch
  - use negative clock to change outputs with another R-S latch
- View pair as one basic unit
  - master-slave flip-flop
  - twice as much logic
  - output changes a few gate delays after the falling edge of clock but does not affect any cascaded flip-flops

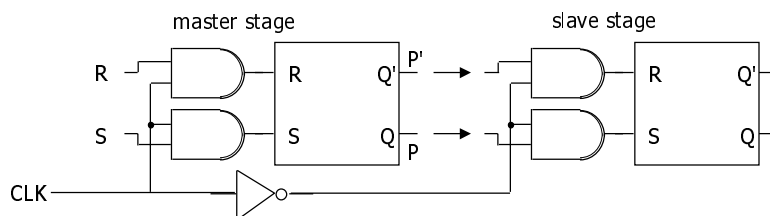

CSE 370 - Spring 2000 - Sequential Logic - 15

## The 1s catching problem

- In first R-S stage of master-slave FF
  - 0-1-0 glitch on R or S while clock is high is "caught" by master stage
  - leads to constraints on logic to be hazard-free

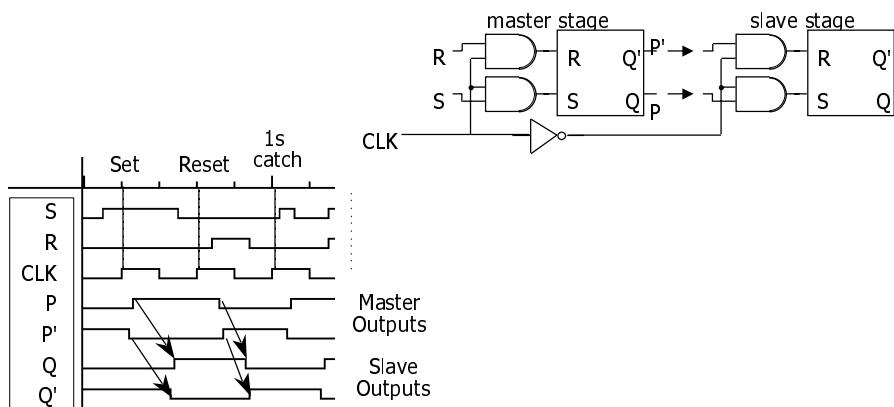

CSE 370 - Spring 2000 - Sequential Logic - 16



## D flip-flop

- Make S and R complements of each other
  - eliminates 1s catching problem
  - can't just hold previous value (must have new value ready every clock period)
  - value of D just before clock goes low is what is stored in flip-flop
  - can make R-S flip-flop by adding logic to make  $D = S + R'Q$

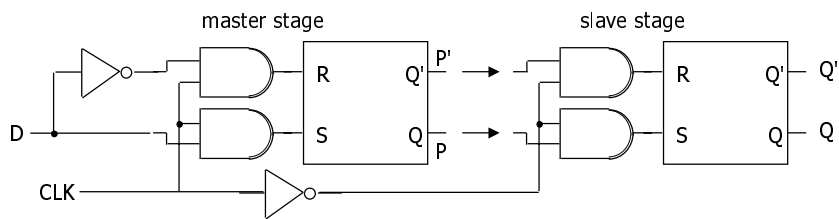

10 gates

CSE 370 - Spring 2000 - Sequential Logic - 17

## Edge-triggered flip-flops

- More efficient solution: only 6 gates
  - sensitive to inputs only near edge of clock signal (not while high)

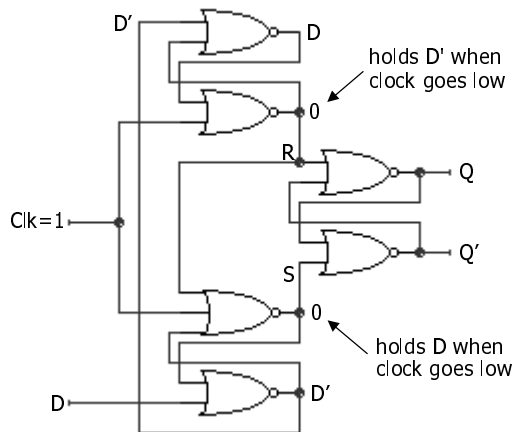

negative edge-triggered D flip-flop (D-FF)

4-5 gate delays

must respect setup and hold time constraints to successfully capture input

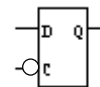

characteristic equation  
 $Q(t+1) = D$

CSE 370 - Spring 2000 - Sequential Logic - 18

## Edge-triggered flip-flops (cont'd)

### ■ Step-by-step analysis

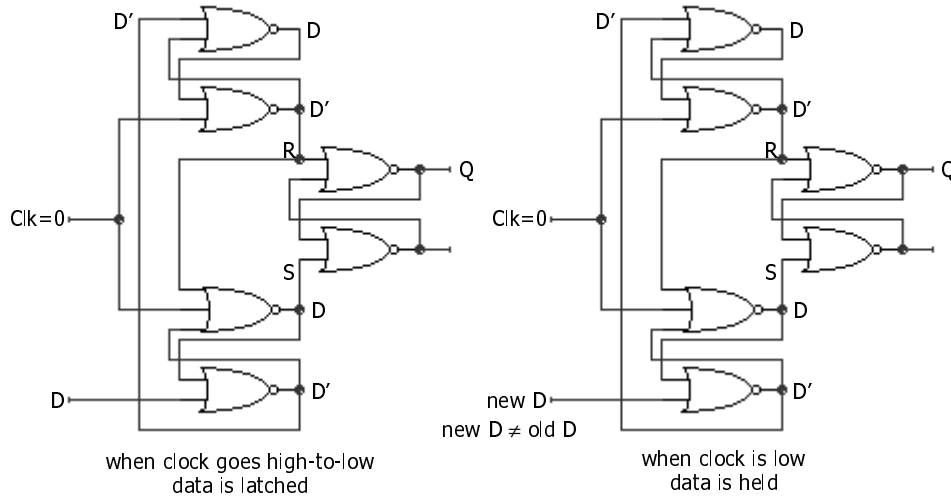

CSE 370 - Spring 2000 - Sequential Logic - 19

## Edge-triggered flip-flops (cont'd)

- Positive edge-triggered
  - inputs sampled on rising edge; outputs change after rising edge
- Negative edge-triggered flip-flops
  - inputs sampled on falling edge; outputs change after falling edge

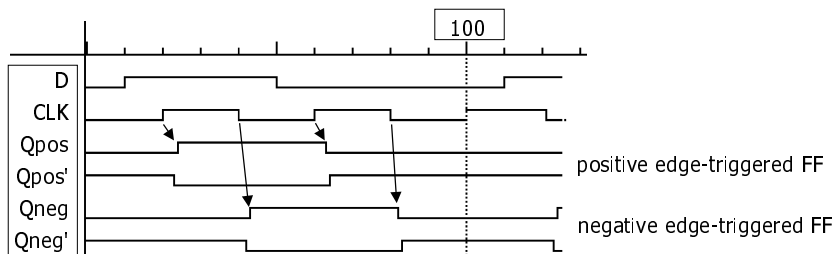

CSE 370 - Spring 2000 - Sequential Logic - 20

## Timing methodologies

- Rules for interconnecting components and clocks
  - ▮ guarantee proper operation of system when strictly followed
- Approach depends on building blocks used for memory elements
  - ▮ we'll focus on systems with edge-triggered flip-flops
    - ▮ found in programmable logic devices
    - ▮ many custom integrated circuits focus on level-sensitive latches
- Basic rules for correct timing:
  - ▮ (1) correct inputs, with respect to time, are provided to the flip-flops
  - ▮ (2) no flip-flop changes state more than once per clocking event

CSE 370 - Spring 2000 - Sequential Logic - 21

## Timing methodologies (cont'd)

- Definition of terms
  - ▮ clock: periodic event, causes state of memory element to change  
can be rising edge or falling edge or high level or low level
  - ▮ setup time: minimum time before the clocking event by which the input must be stable ( $T_{su}$ )
  - ▮ hold time: minimum time after the clocking event until which the input must remain stable ( $T_h$ )

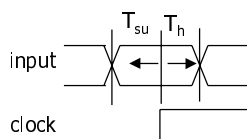

there is a timing "window" around the clocking event during which the input must remain stable and unchanged in order to be recognized

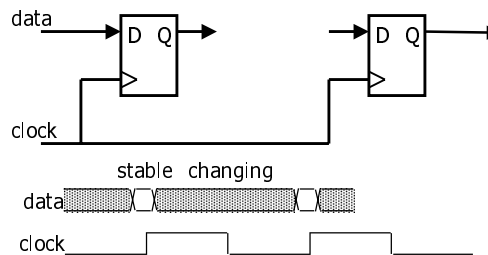

CSE 370 - Spring 2000 - Sequential Logic - 22

## Comparison of latches and flip-flops

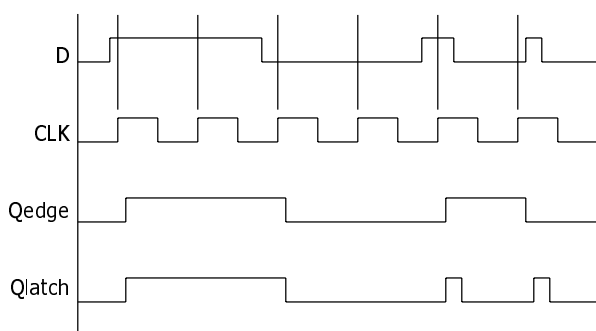
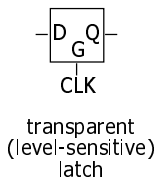
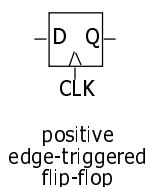

behavior is the same unless input changes  
while the clock is high

CSE 370 - Spring 2000 - Sequential Logic - 23

## Comparison of latches and flip-flops (cont'd)

Type	When inputs are sampled	When output is valid
unclocked latch	always	propagation delay from input change
level-sensitive latch	clock high ( $T_{su}/T_{th}$ around falling edge of clock)	propagation delay from input change or clock edge (whichever is later)
master-slave flip-flop	clock high ( $T_{su}/T_{th}$ around falling edge of clock)	propagation delay from falling edge of clock
negative edge-triggered flip-flop	clock hi-to-lo transition ( $T_{su}/T_{th}$ around falling edge of clock)	propagation delay from falling edge of clock

CSE 370 - Spring 2000 - Sequential Logic - 24

## Typical timing specifications

- Positive edge-triggered D flip-flop
  - setup and hold times
  - minimum clock width
  - propagation delays (low to high, high to low, max and typical)

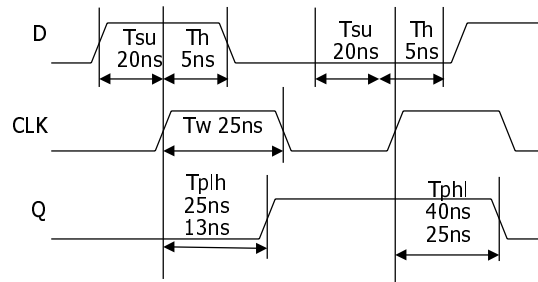

all measurements are made from the clocking event that is, the rising edge of the clock

CSE 370 - Spring 2000 - Sequential Logic - 25

## Cascading edge-triggered flip-flops

- Shift register
  - new value goes into first stage
  - while previous value of first stage goes into second stage
  - consider setup/hold/propagation delays (prop must be > hold)

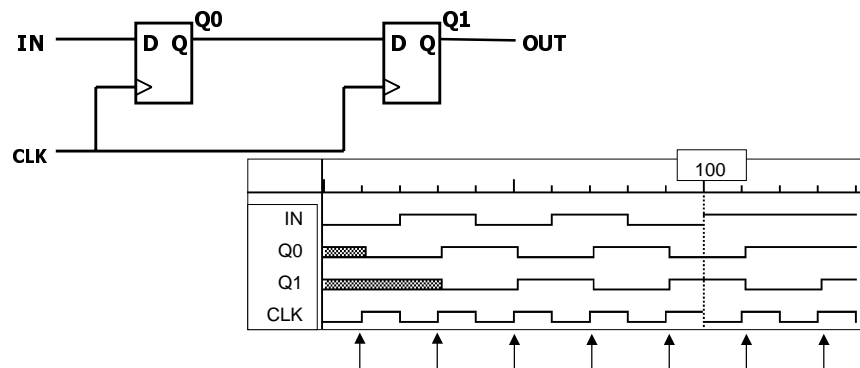

CSE 370 - Spring 2000 - Sequential Logic - 26

## Cascading edge-triggered flip-flops (cont'd)

- Why this works
  - propagation delays exceed hold times
  - clock width constraint exceeds setup time
  - this guarantees following stage will latch current value before it changes to new value

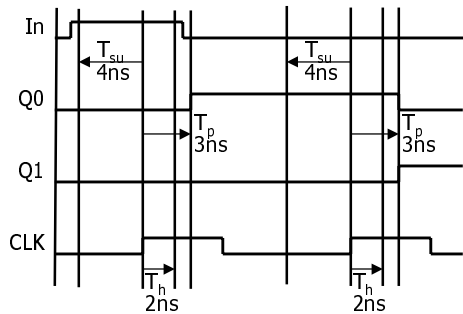

timing constraints  
guarantee proper  
operation of  
cascaded components

assumes infinitely fast  
distribution of the clock

CSE 370 - Spring 2000 - Sequential Logic - 27

## Clock skew

- The problem
  - correct behavior assumes next state of all storage elements determined by all storage elements at the same time
  - this is difficult in high-performance systems because time for clock to arrive at flip-flop is comparable to delays through logic
  - effect of skew on cascaded flip-flops:

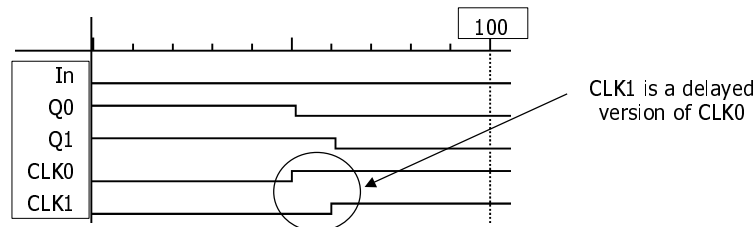

original state: IN = 0, Q0 = 1, Q1 = 1  
due to skew, next state becomes: Q0 = 0, Q1 = 0, and not Q0 = 0, Q1 = 1

CSE 370 - Spring 2000 - Sequential Logic - 28

## Summary of latches and flip-flops

- Development of D-FF
  - ┆ level-sensitive used in custom integrated circuits
    - ┆ can be made with 4 switches
  - ┆ edge-triggered used in programmable logic devices
  - ┆ good choice for data storage register
- Historically J-K FF was popular but now never used
  - ┆ similar to R-S but with 1-1 being used to toggle output (complement state)
  - ┆ good in days of TTL/SSI (more complex input function:  $D = JQ' + K'Q$ )
  - ┆ not a good choice for PALs/PLAs as it requires 2 inputs
  - ┆ can always be implemented using D-FF
- Preset and clear inputs are highly desirable on flip-flops
  - ┆ used at start-up or to reset system to a known state

CSE 370 - Spring 2000 - Sequential Logic - 29

## Metastability and asynchronous inputs

- Clocked synchronous circuits
  - ┆ inputs, state, and outputs sampled or changed in relation to a common reference signal (called the clock)
  - ┆ e.g., master/slave, edge-triggered
- Asynchronous circuits
  - ┆ inputs, state, and outputs sampled or changed independently of a common reference signal (glitches/hazards a major concern)
  - ┆ e.g., R-S latch
- Asynchronous inputs to synchronous circuits
  - ┆ inputs can change at any time, will not meet setup/hold times
  - ┆ dangerous, synchronous inputs are greatly preferred
  - ┆ cannot be avoided (e.g., reset signal, memory wait, user input)

CSE 370 - Spring 2000 - Sequential Logic - 30

## Synchronization failure

- Occurs when FF input changes close to clock edge
  - the FF may enter a metastable state – neither a logic 0 nor 1 –
  - it may stay in this state an indefinite amount of time
  - this is not likely in practice but has some probability

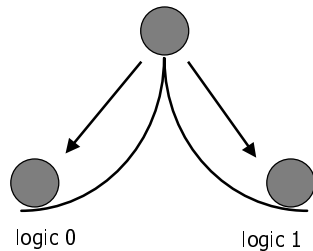

small, but non-zero probability that the FF output will get stuck in an in-between state

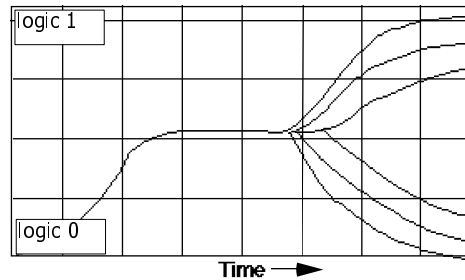

oscilloscope traces demonstrating synchronizer failure and eventual decay to steady state

CSE 370 - Spring 2000 - Sequential Logic - 31

## Dealing with synchronization failure

- Probability of failure can never be reduced to 0, but it can be reduced
  - (1) slow down the system clock  
this gives the synchronizer more time to decay into a steady state; synchronizer failure becomes a big problem for very high speed systems
  - (2) use fastest possible logic technology in the synchronizer  
this makes for a very sharp "peak" upon which to balance
  - (3) cascade two synchronizers  
this effectively synchronizes twice (both would have to fail)

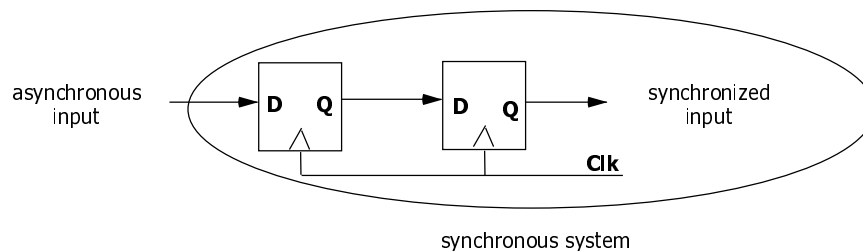

CSE 370 - Spring 2000 - Sequential Logic - 32



## Handling asynchronous inputs

- Never allow asynchronous inputs to fan-out to more than one flip-flop
  - synchronize as soon as possible and then treat as synchronous signal

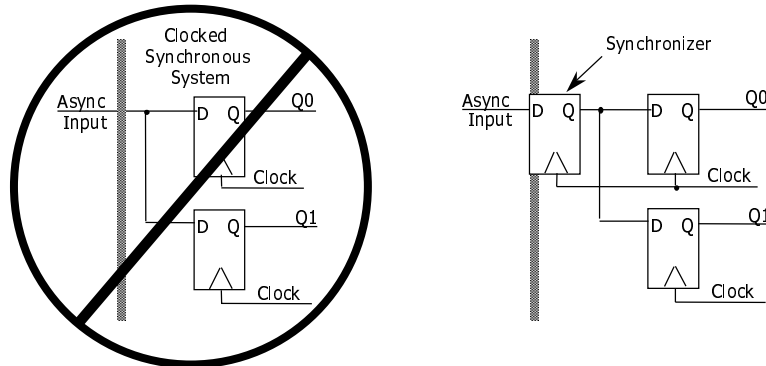

CSE 370 - Spring 2000 - Sequential Logic - 33

## Handling asynchronous inputs (cont'd)

- What can go wrong?
  - input changes too close to clock edge (violating setup time constraint)

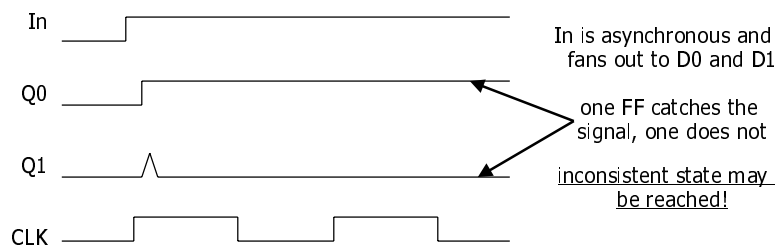

CSE 370 - Spring 2000 - Sequential Logic - 34

## Flip-flop features

- Reset (set state to 0) – R
  - ▮ synchronous:  $D_{new} = R' \cdot D_{old}$  (when next clock edge arrives)
  - ▮ asynchronous: doesn't wait for clock, quick but dangerous
- Preset or set (set state to 1) – S (or sometimes P)
  - ▮ synchronous:  $D_{new} = D_{old} + S$  (when next clock edge arrives)
  - ▮ asynchronous: doesn't wait for clock, quick but dangerous
- Both reset and preset
  - ▮  $D_{new} = R' \cdot D_{old} + S$  (set-dominant)
  - ▮  $D_{new} = R' \cdot D_{old} + R'S$  (reset-dominant)
- Selective input capability (input enable or load) – LD or EN
  - ▮ multiplexor at input:  $D_{new} = LD' \cdot Q + LD \cdot D_{old}$
  - ▮ load may or may not override reset/set (usually R/S have priority)
- Complementary outputs – Q and Q'

CSE 370 - Spring 2000 - Sequential Logic - 35

## Registers

- Collections of flip-flops with similar controls and logic
  - ▮ stored values somehow related (for example, form binary value)
  - ▮ share clock, reset, and set lines
  - ▮ similar logic at each stage
- Examples
  - ▮ shift registers
  - ▮ counters

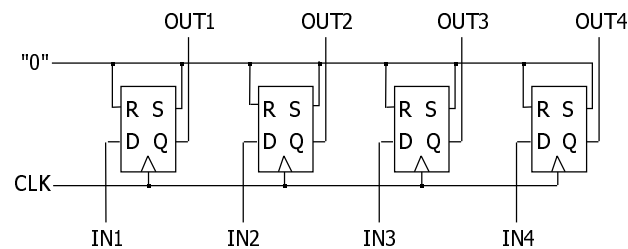

CSE 370 - Spring 2000 - Sequential Logic - 36

## Shift register

- Holds samples of input
  - store last 4 input values in sequence
  - 4-bit shift register:

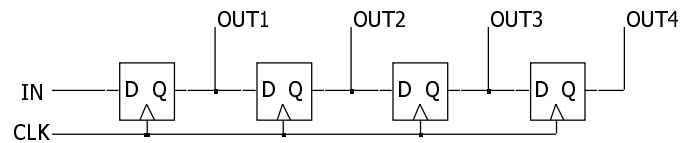

CSE 370 - Spring 2000 - Sequential Logic - 37

## Universal shift register

- Holds 4 values
  - serial or parallel inputs
  - serial or parallel outputs
  - permits shift left or right
  - shift in new values from left or right

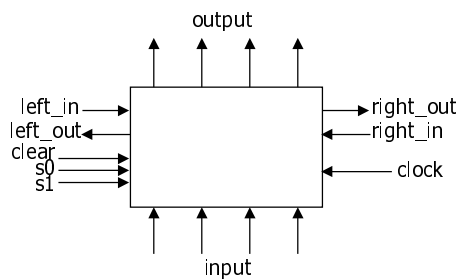

clear sets the register contents and output to 0

s1 and s0 determine the shift function

s0	s1	function
0	0	hold state
0	1	shift right
1	0	shift left
1	1	load new input

CSE 370 - Spring 2000 - Sequential Logic - 38

## Design of universal shift register

- Consider one of the four flip-flops
- new value at next clock cycle:

clear	s0	s1	new value
1	-	-	0
0	0	0	output
0	0	1	output value of FF to left (shift right)
0	1	0	output value of FF to right (shift left)
0	1	1	input

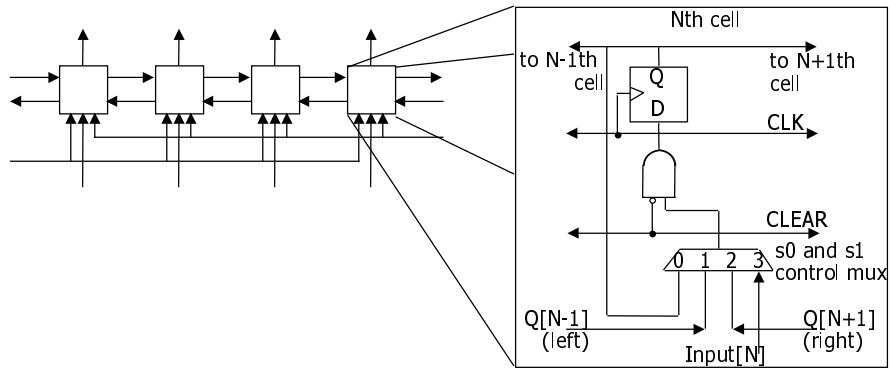

CSE 370 - Spring 2000 - Sequential Logic - 39

## Shift register application

- Parallel-to-serial conversion for serial transmission

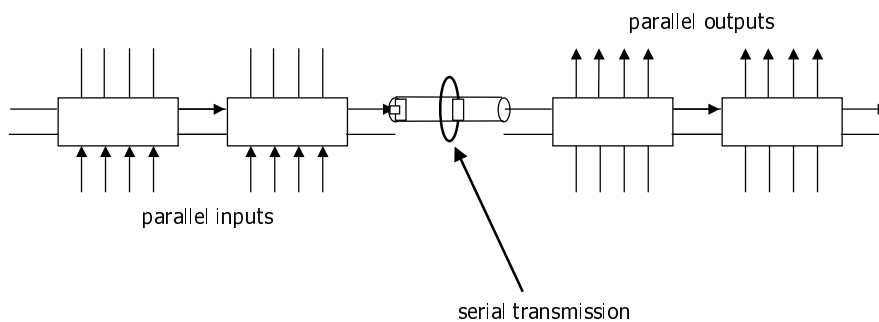

CSE 370 - Spring 2000 - Sequential Logic - 40

## Pattern recognizer

- Combinational function of input samples
  - in this case, recognizing the pattern 1001 on the single input signal

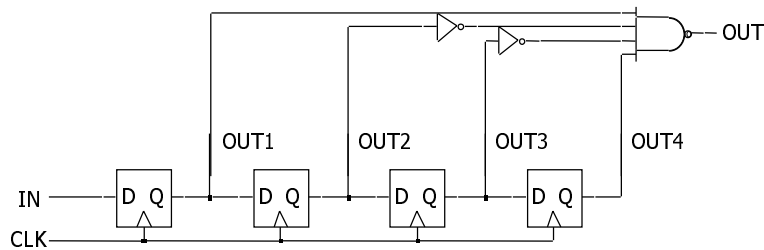

CSE 370 - Spring 2000 - Sequential Logic - 41

## Counters

- Sequences through a fixed set of patterns
  - in this case, 1000, 0100, 0010, 0001
  - if one of the patterns is its initial state (by loading or set/reset)

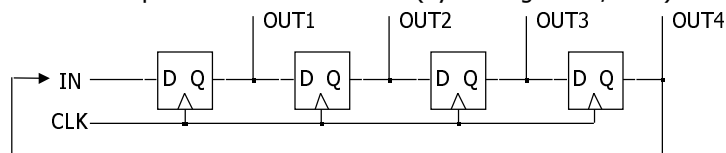

- Mobius (or Johnson) counter
  - in this case, 1000, 1100, 1110, 1111, 0111, 0011, 0001, 0000

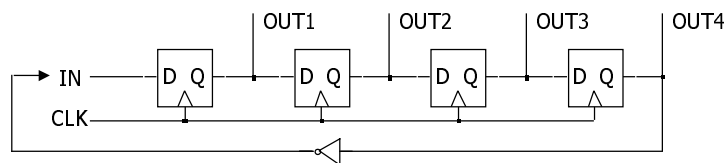

CSE 370 - Spring 2000 - Sequential Logic - 42

## Binary counter

- Logic between registers (not just multiplexer)
  - XOR decides when bit should be toggled
  - always for low-order bit,
  - only when first bit is true for second bit,
  - and so on

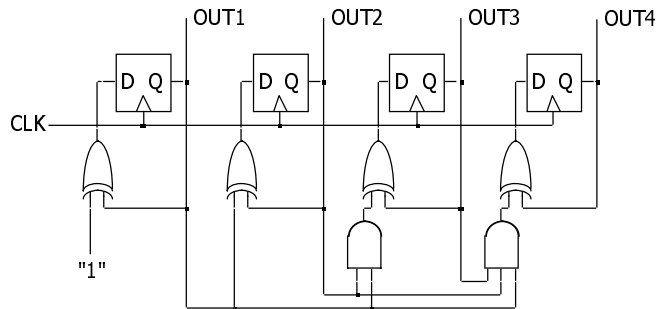

CSE 370 - Spring 2000 - Sequential Logic - 43

## Four-bit binary synchronous up-counter

- Standard component with many applications
  - positive edge-triggered FFs w/ synchronous load and clear inputs
  - parallel load data from D, C, B, A
  - enable inputs: must be asserted to enable counting
  - RCO: ripple-carry out used for cascading counters
    - high when counter is in its highest state 1111
    - implemented using an AND gate

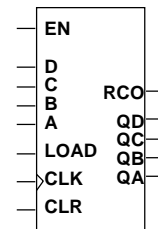
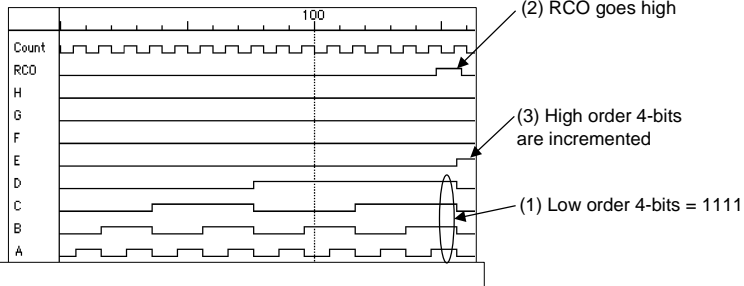

CSE 370 - Spring 2000 - Sequential Logic - 44

## Offset counters

- Starting offset counters – use of synchronous load
  - ▮ e.g., 0110, 0111, 1000, 1001, 1010, 1011, 1100, 1101, 1111, 0110, . . .

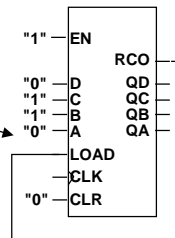

- Ending offset counter – comparator for ending value
  - ▮ e.g., 0000, 0001, 0010, . . ., 1100, 1101, 0000

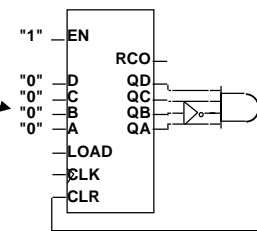

- Combinations of the above (start and stop value)

CSE 370 - Spring 2000 - Sequential Logic - 45

## Sequential logic summary

- Fundamental building block of circuits with state
  - ▮ latch and flip-flop
  - ▮ R-S latch, R-S master/slave, D master/slave, edge-triggered D flip-flop
- Timing methodologies
  - ▮ use of clocks
  - ▮ cascaded FFs work because propagation delays exceed hold times
  - ▮ beware of clock skew
- Asynchronous inputs and their dangers
  - ▮ synchronizer failure: what it is and how to minimize its impact
- Basic registers
  - ▮ shift registers
  - ▮ pattern detectors
  - ▮ counters

CSE 370 - Spring 2000 - Sequential Logic - 46