

CSE 373: Data Structures and Algorithms

Lecture 11: Priority Queues (Heaps)

Motivating examples

- **Bandwidth management:** A router is connected to a line with limited bandwidth. If there is insufficient bandwidth, the router maintains a queue for incoming data such that the most important data will get forwarded first as bandwidth becomes available.
- **Printing:** A shared server has a list of print jobs to print. It wants to print them in chronological order, but each print job also has a *priority*, and higher-priority jobs always print before lower-priority jobs
- **Algorithms:** We are writing a ghost AI algorithm for Pac-Man. It needs to search for the best path to find Pac-Man; it will enqueue all possible paths with priorities (based on guesses about which one will succeed), and try them in order.

Priority Queue ADT

- **priority queue**: A collection of elements that provides fast access to the minimum (or maximum) element
 - a mix between a queue and a BST
- basic priority queue operations:
 - **insert**: Add an element to the priority queue (priority matters)
 - **remove (i.e. deleteMin)**: Removes/returns minimum element

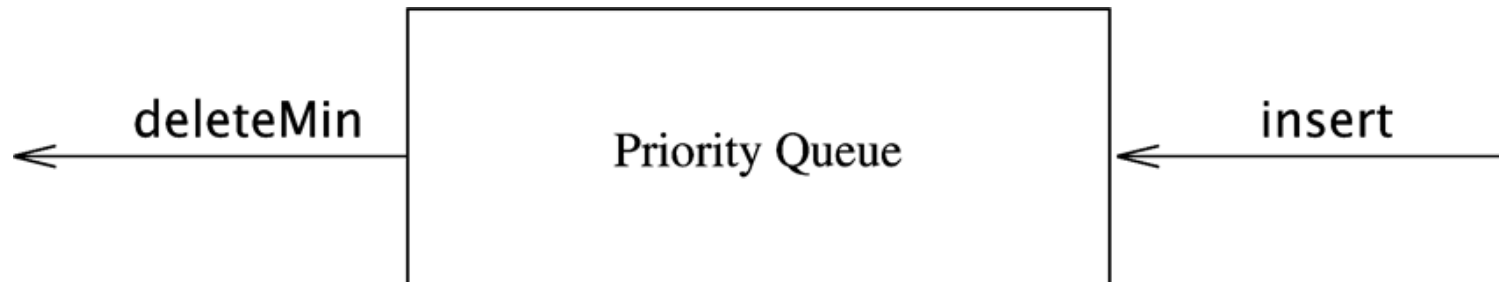

Using PriorityQueue

<code>PriorityQueue<E> ()</code>	constructs a <code>PriorityQueue</code> that orders the elements according to their <code>compareTo</code> (element type must implement <code>Comparable</code>)
<code>add (element)</code>	inserts the element into the <code>PriorityQueue</code>
<code>remove ()</code>	removes and returns the element at the head of the queue
<code>peek ()</code>	returns, but does not remove, the element at the head of the queue

```
Queue<String> pq = new PriorityQueue<String> ();  
pq.add ("Kona");  
pq.add ("Daisy");
```

– implements `Queue` interface

Potential Implementations

	insert	deleteMin
Unsorted list (Array)		
Unsorted list (Linked-List)		
Sorted list (Array)		
Sorted list (Linked-List)		
Binary Search Tree		
AVL Trees		

Potential Implementations

	insert	deleteMin
Unsorted list (Array)	$\Theta(1)$	$\Theta(n)$
Unsorted list (Linked-List)	$\Theta(1)$	$\Theta(n)$
Sorted list (Array)	$\Theta(n)$	$\Theta(1)^*$
Sorted list (Linked-List)	$\Theta(n)$	$\Theta(1)$
Binary Search Tree	$\Theta(n)$ worst	$\Theta(n)$ worst
AVL Trees	$\Theta(\log n)$	$\Theta(\log n)$

Heap properties

- **heap**: a tree with the following two properties:

- 1. *completeness*

complete tree: every level is full except possibly the lowest level, which must be filled from left to right with no leaves to the right of a missing node (i.e., a node may not have any children until all of its possible siblings exist)

Heap shape:

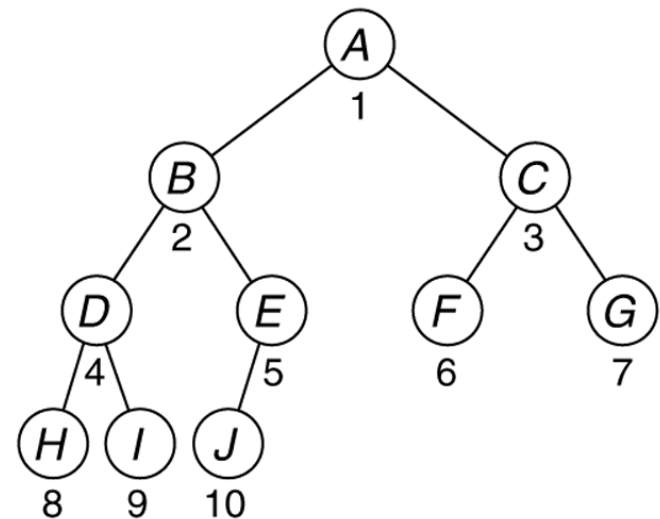
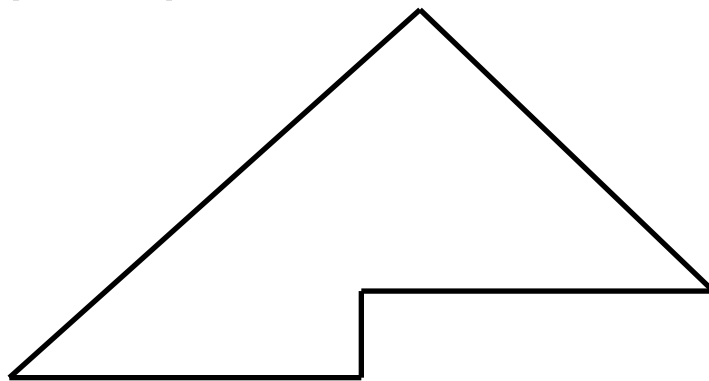

Heap properties 2

– 2. *heap ordering*

a tree has *heap ordering* if $P \leq X$ for every element X with parent P

- in other words, in heaps, parents' element values are always smaller than those of their children
- implies that minimum element is always the root
- is every a heap a BST? Are any heaps BSTs?



$$P \leq X$$

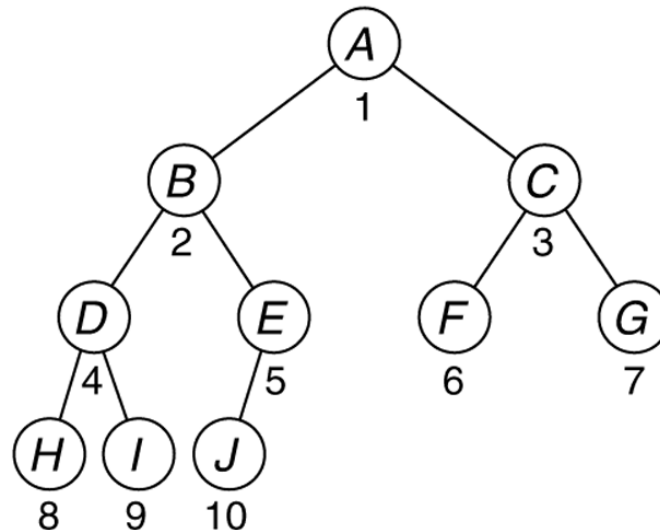

Which are min-heaps?

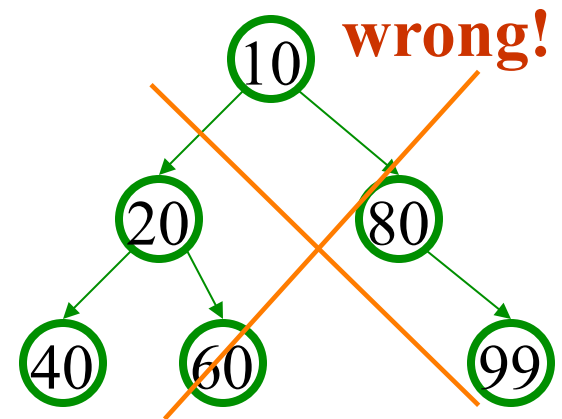
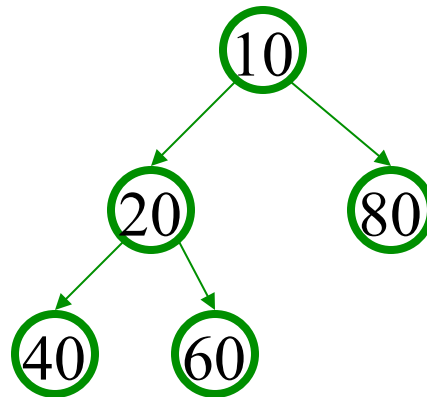
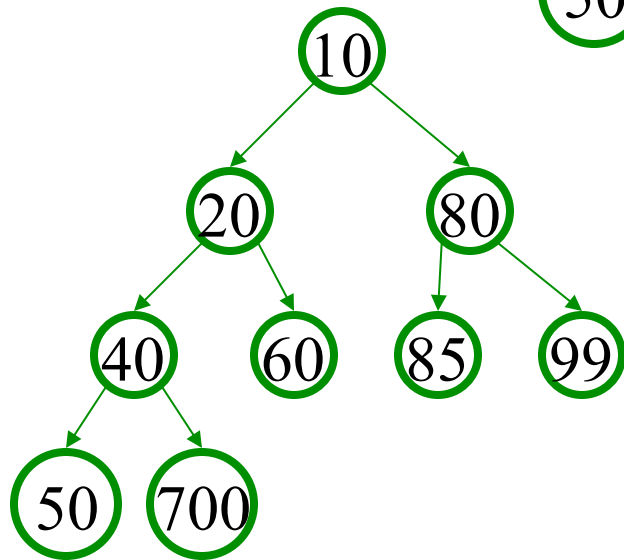
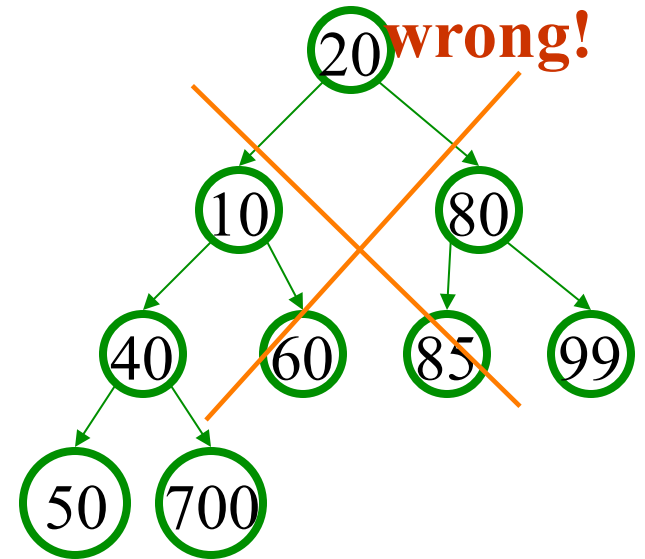
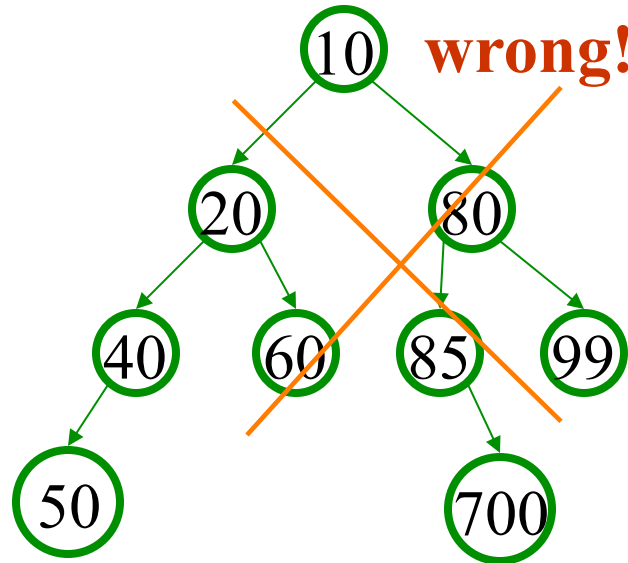
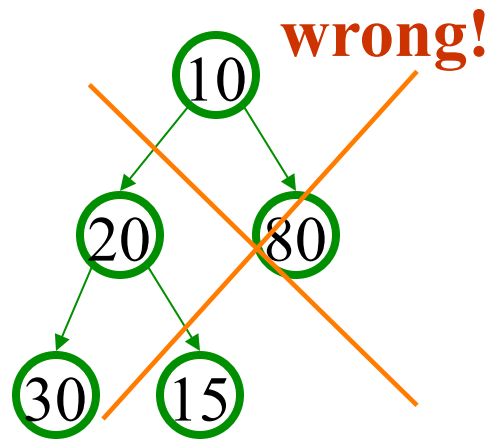

Which are max-heaps?

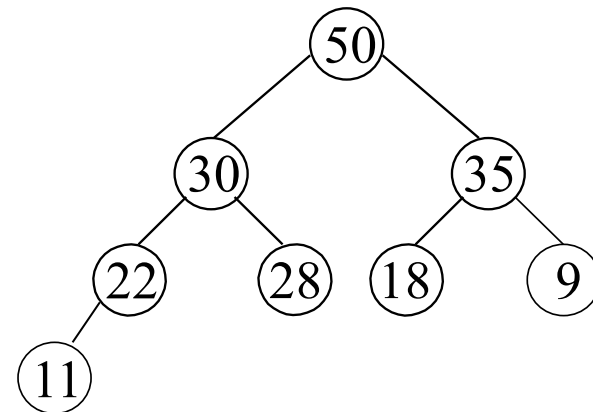
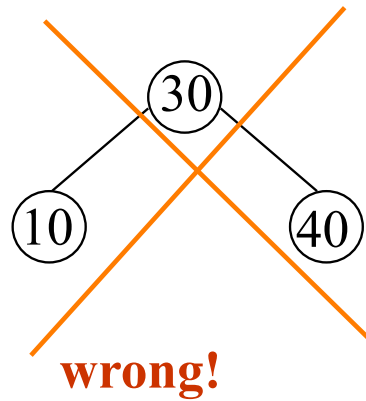
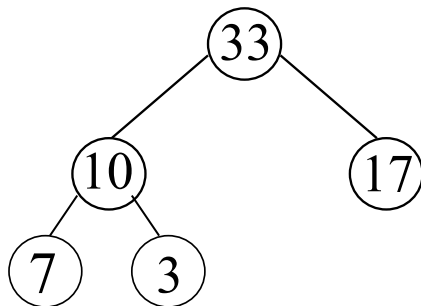
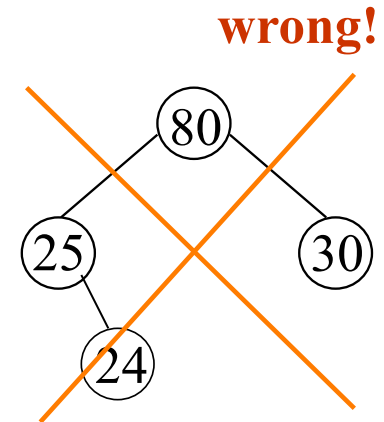
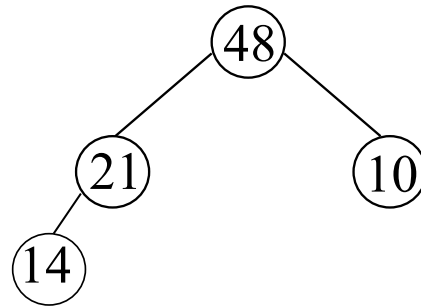
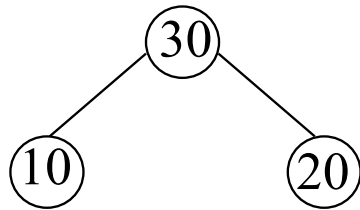

Heap height and runtime

- height of a complete tree is always $\log n$, because it is always balanced
 - because of this, if we implement a priority queue using a heap, we can provide the $O(\log n)$ runtime required for the `add` and `remove` operations

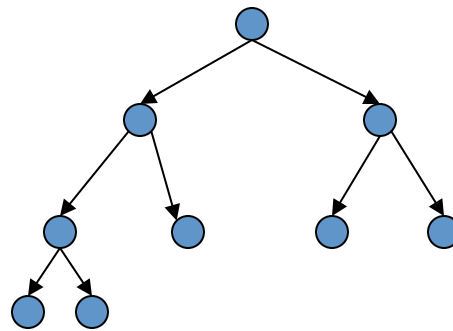
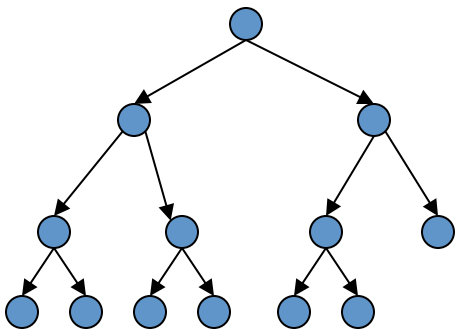

n -node
complete tree
of height h :
 $2^h \leq n \leq 2^{h+1} - 1$
 $h = \lfloor \log n \rfloor$

Implementation of a heap

- when implementing a complete binary tree, we actually can "cheat" and just use an array
 - index of root = 1 (leave 0 empty for simplicity)
 - for any node n at index i ,
 - index of n .left = $2i$
 - index of n .right = $2i + 1$
 - parent index?

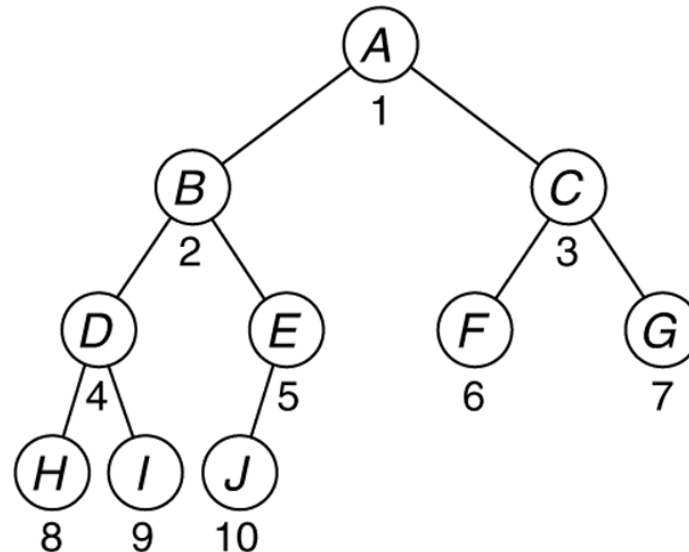

Implementing Priority Queue with Binary Heap

```
public interface IntPriorityQueue {
    public void add(int value);
    public boolean isEmpty();
    public int peek();
    public int remove();
}

public class IntBinaryHeap implements IntPriorityQueue {
    private static final int DEFAULT_CAPACITY = 10;
    private int[] array;
    private int size;

    public IntBinaryHeap () {
        array = new int[DEFAULT_CAPACITY];
        size = 0;
    }
    ...
}
```

Adding to a heap

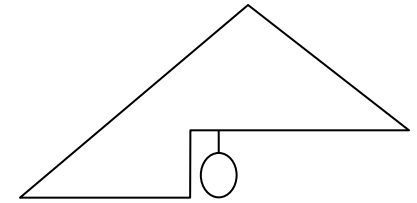

- when an element is added to a heap, it should be initially placed as the rightmost leaf (to maintain the completeness property)
 - heap ordering property becomes broken!

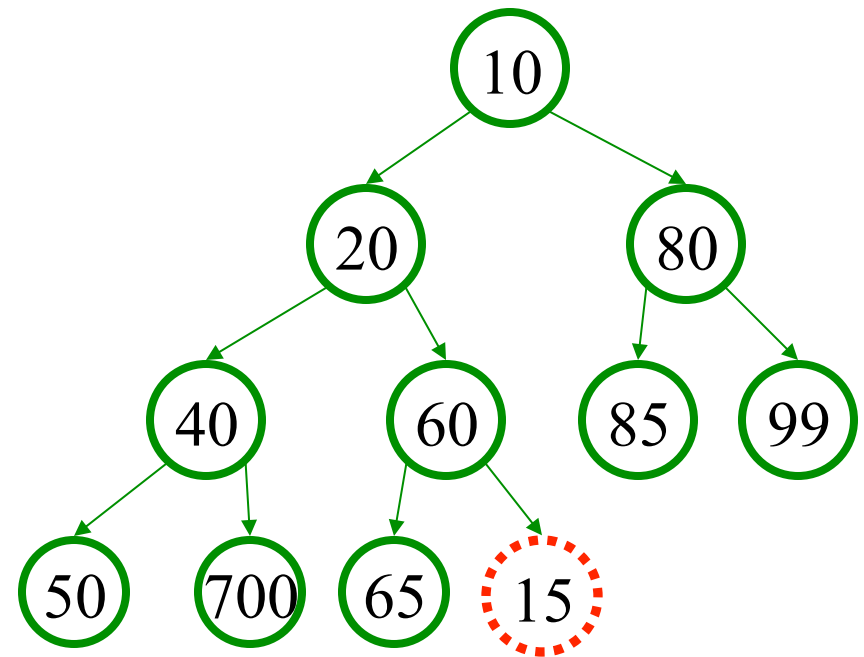
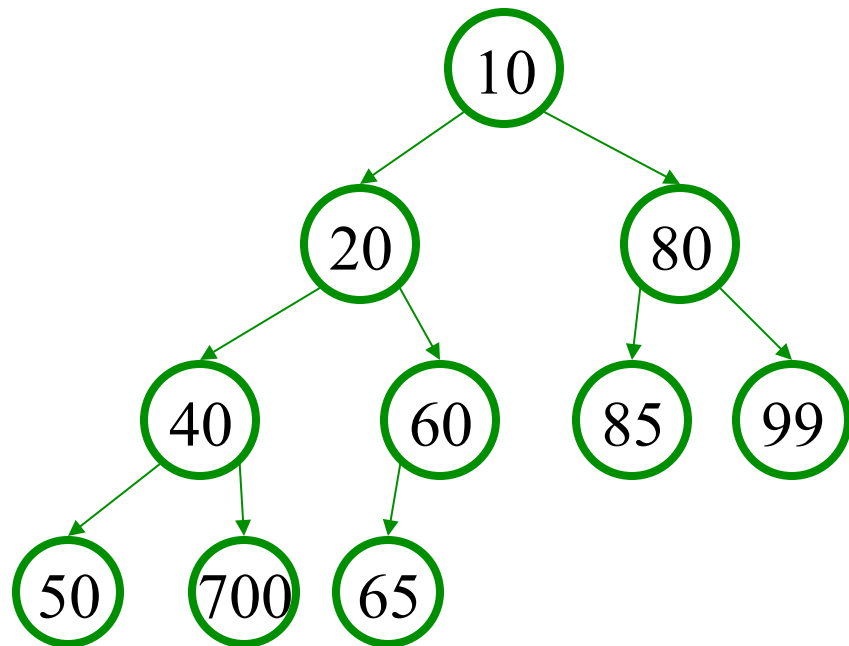

Adding to a heap, cont'd.

- to restore heap ordering property, the newly added element must be shifted upward ("bubbled up") until it reaches its proper place
 - bubble up (book: "percolate up") by swapping with parent
 - how many bubble-ups could be necessary, at most?

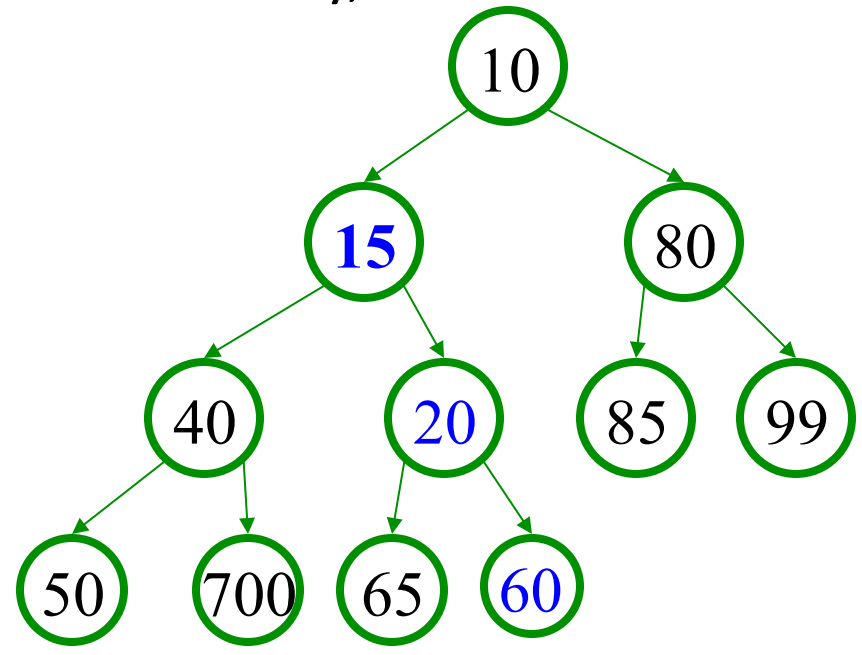
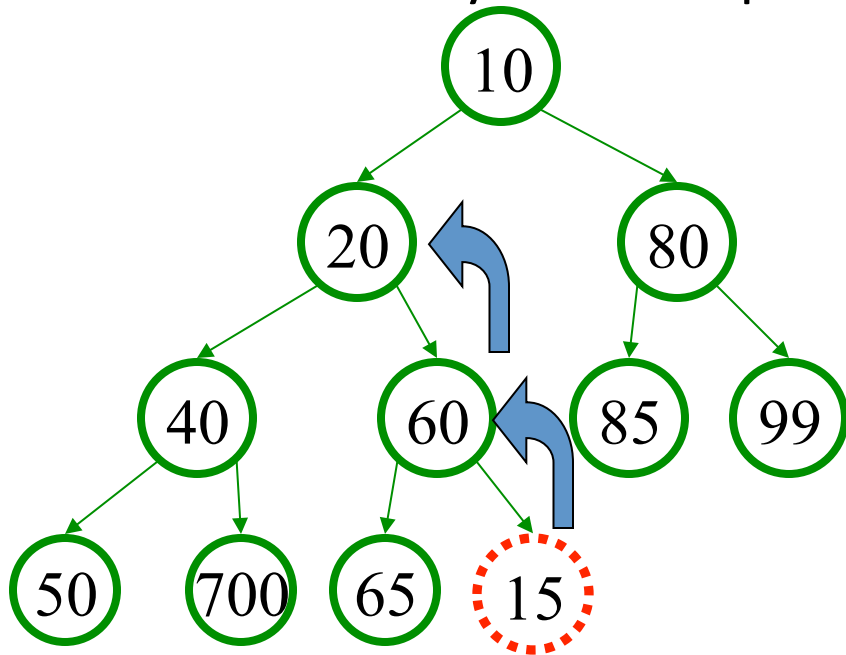

Adding to a max-heap

- same operations, but must bubble up *larger* values to top

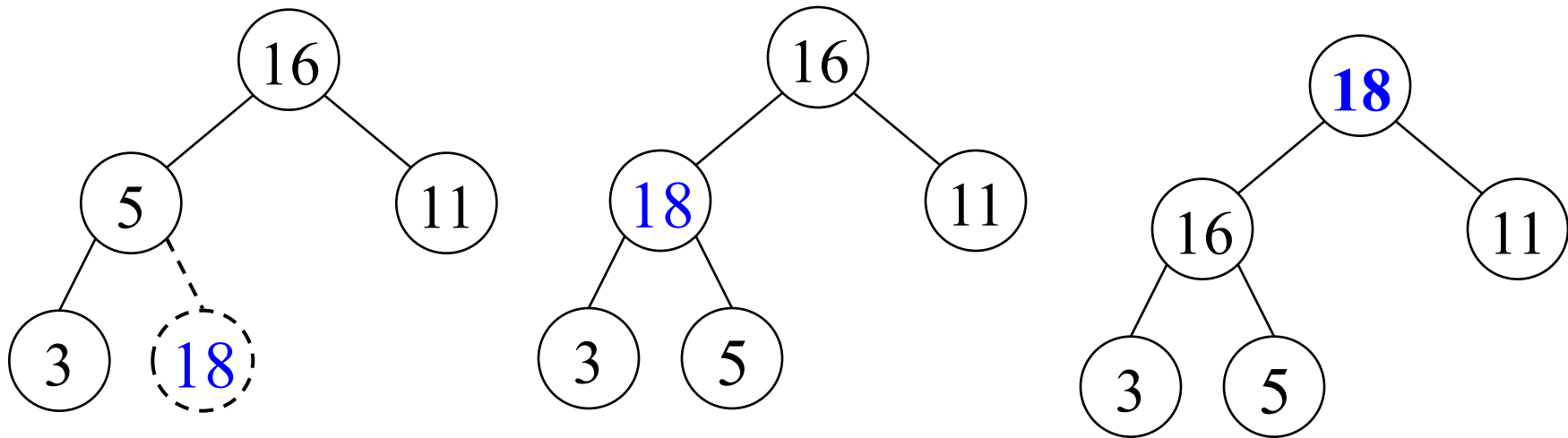

Heap practice problem

- Draw the state of the min-heap tree after adding the following elements to it:

6, 50, 11, 25, 42, 20, 104, 76, 19, 55, 88, 2

Code for add method

```
public void add(int value) {  
    // grow array if needed  
    if (size >= array.length - 1) {  
        array = this.resize();  
    }  
  
    // place element into heap at bottom  
    size++;  
    int index = size;  
    array[index] = value;  
  
    bubbleUp() ;  
}
```

The bubbleUp helper

```
private void bubbleUp() {
    int index = this.size;

    while (hasParent(index)
        && (parent(index) > array[index])) {
        // parent/child are out of order; swap them
        swap(index, parentIndex(index));
        index = parentIndex(index);
    }
}

// helpers
private boolean hasParent(int i) { return i > 1; }
private int parentIndex(int i)    { return i/2; }
private int parent(int i)        { return array[parentIndex(i)]; }
```

The peek operation

- peek on a min-heap is trivial; because of the heap properties, the minimum element is always the root
 - peek is $O(1)$
 - peek on a max-heap would be $O(1)$ as well, but would return you the maximum element and not the minimum one

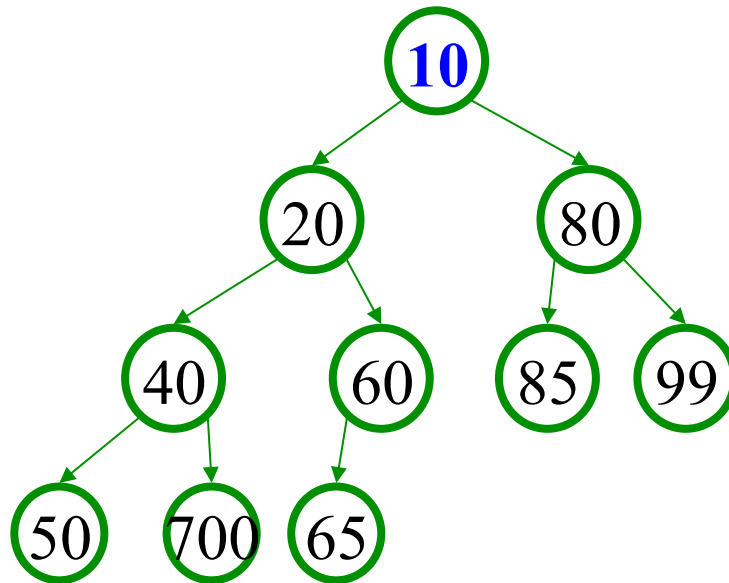

Code for peek method

```
public int peek() {  
    if (this.isEmpty()) {  
        throw new IllegalStateException();  
    }  
  
    return array[1];  
}
```