

# 3D Models and Matching

- representations for 3D object models
- particular matching techniques
- alignment-based systems
- appearance-based systems



GC model of a screwdriver

# 3D Models

- Many different representations have been used to model 3D objects.
- Some are very **coarse**, just picking up the important features.
- Others are very **fine**, describing the entire surface of the object.
- Usually, the recognition procedure depends very much on the type of model.

# Mesh Models

Mesh models were originally for computer graphics.

With the current availability of range data, they are now used for 3D object recognition.

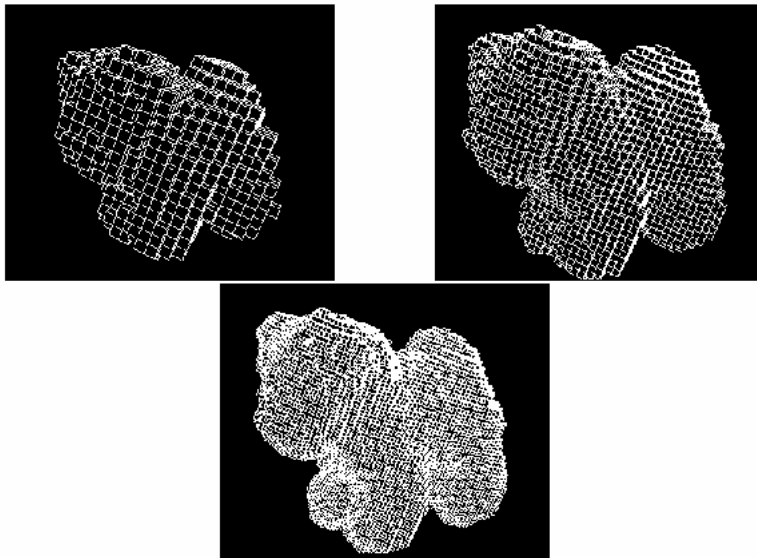

What types of features  
can we extract from meshes  
for matching ?

In addition to matching,  
they can be used for  
verification.

# Surface-Edge-Vertex Models

SEV models are at the opposite extreme from mesh models.

They specify the (usually linear) features that would be extracted from 2D or 3D data.

They are suitable for objects with **sharp edges and corners** that are easily detectable and characterize the object.

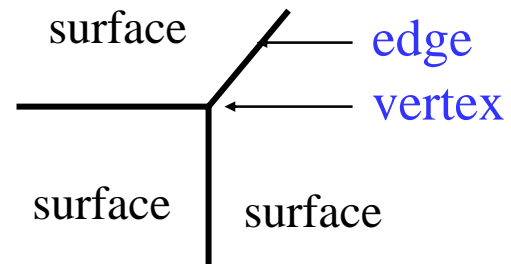
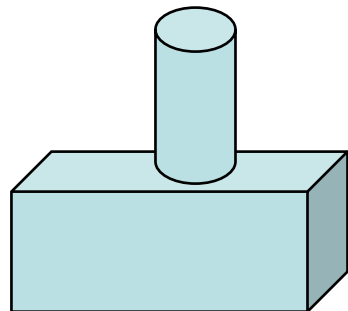

# Generalized-Cylinders

A **generalized cylinder** is a volumetric primitive defined by:

- a space curve axis
- a cross section function

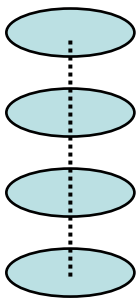

standard  
cylinder

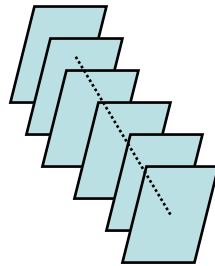

rectangular  
cross sections

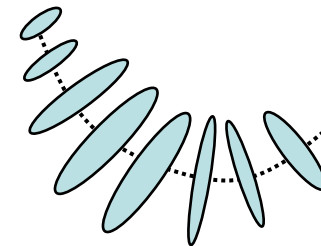

This cylinder has

- curved axis
- varying cross section

# Generalized-Cylinder Models

Generalized cylinder models include:

1. a set of generalized cylinders
2. the spatial relationships among them
3. the global properties of the object

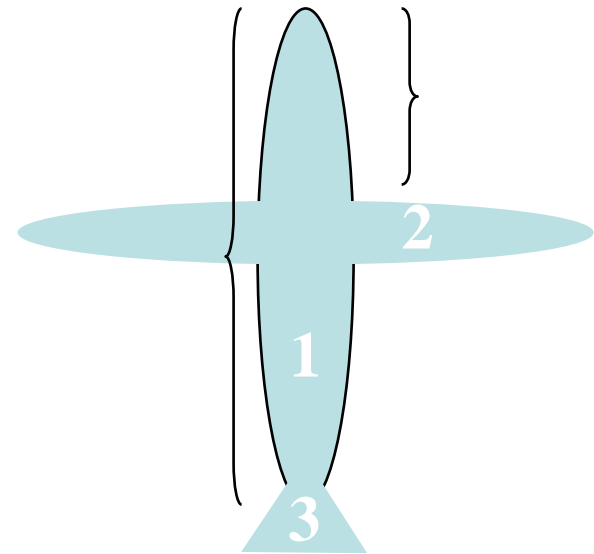
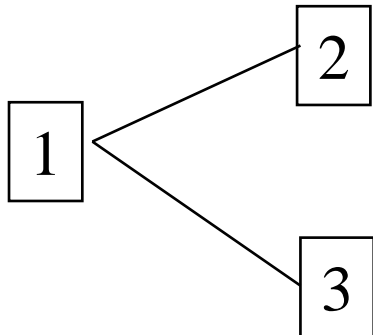

How can we describe the attributes of the cylinders and of their connections?

# Finding GCs in Intensity Data

Generalized cylinder models have been used for several different classes of objects:

- airplanes (Brooks)
- animals (Marr and Nishihara)
- humans (Medioni)
- human anatomy (Zhenrong Qian)

The 2D projections of standard GCs are

- ribbons
- ellipses

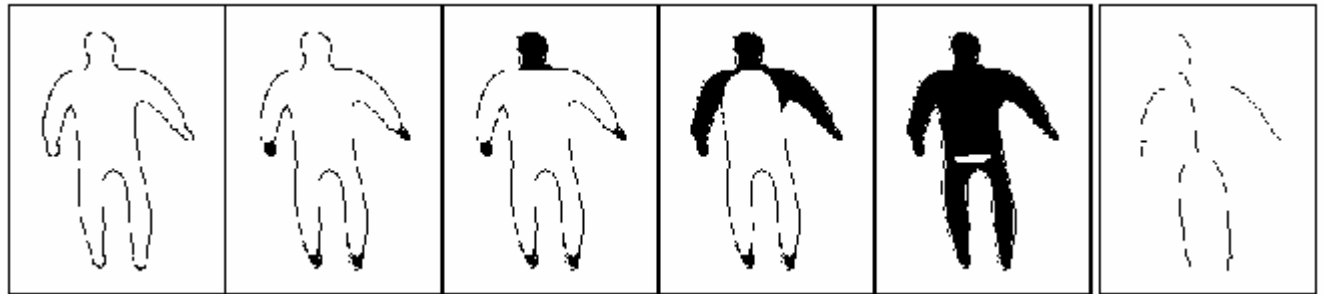

# Octrees

- Octrees are 8-ary tree structures that compress a voxel representation of a 3D object.
- Kari Puli used them to represent the 3D objects during the space carving process.
- They are sometimes used for medical object representation.

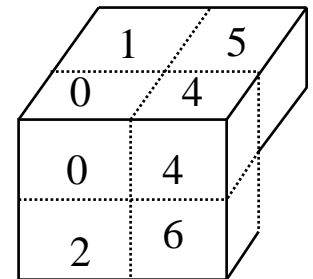
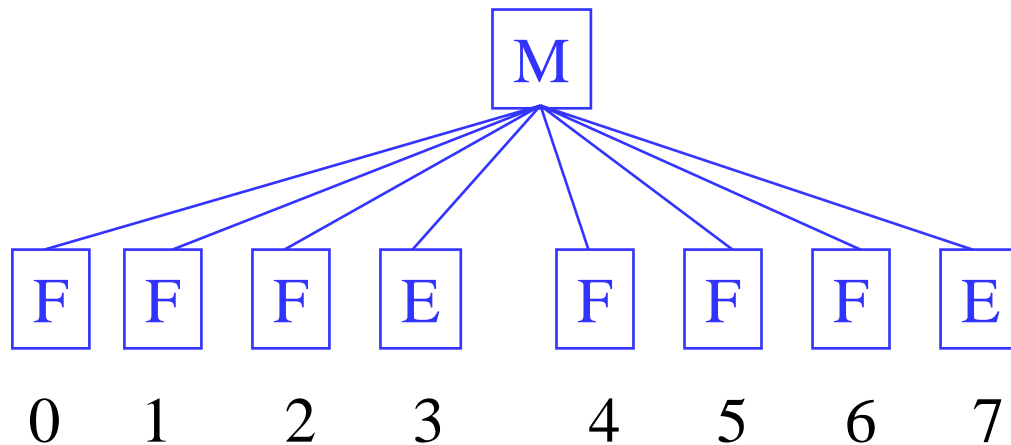



# Superquadrics

- Superquadrics are parameterized equations that describe solid shapes algebraically.
- They have been used for graphics and for representing some organs of the human body, ie. the heart.

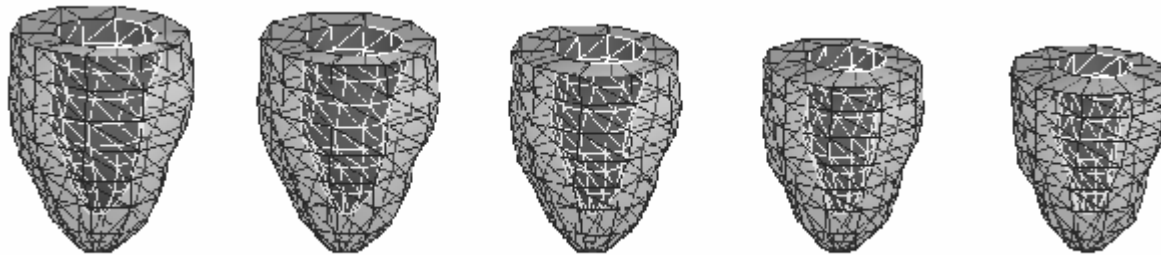

# 2D Deformable Models

A 2D deformable model or **snake** is a function that is fit to some real data, along its contours.



The fitting mimizes:

- internal energy of the contour (smoothness)
- image energy (fit to data)
- external energy (user-defined constraints)

# 3D Deformable Models

In 3D, the snake concept becomes a **balloon** that expands to fill a point cloud of 3D data.



(a) Initialization with balloon entirely within the 3D point cloud.

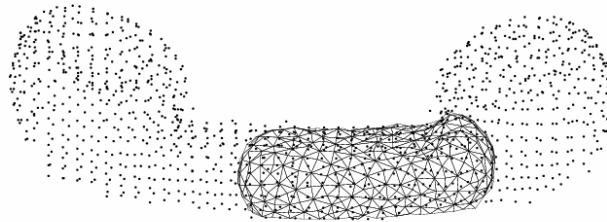

(b) Balloon inflated so that some triangles contact data.

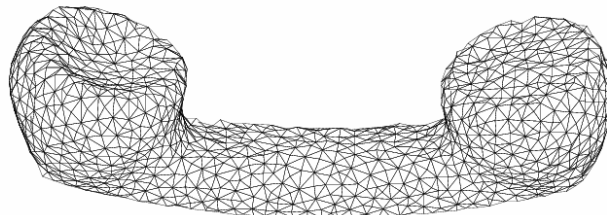

(c) Triangular mesh at termination.

# Matching Geometric Models via Alignment

Alignment is the most common paradigm for matching 3D models to either 2D or 3D data. The steps are:

1. **hypothesize a correspondence** between a set of model points and a set of data points
2. From the correspondence **compute a transformation** from model to data
3. **Apply the transformation** to the model features to produce transformed features
4. **Compare** the transformed model features to the image features to verify or disprove the hypothesis

# 3D-3D Alignment of Mesh Models to Mesh Data

- Older Work: match 3D features such as 3D edges and junctions or surface patches
- More Recent Work: match surface signatures
  - curvature at a point
  - curvature histogram in the neighborhood of a point
  - Medioni's splashes
  - \* - Johnson and Hebert's spin images

# The Spin Image Signature

$P$  is the selected vertex.

$X$  is a contributing point of the mesh.

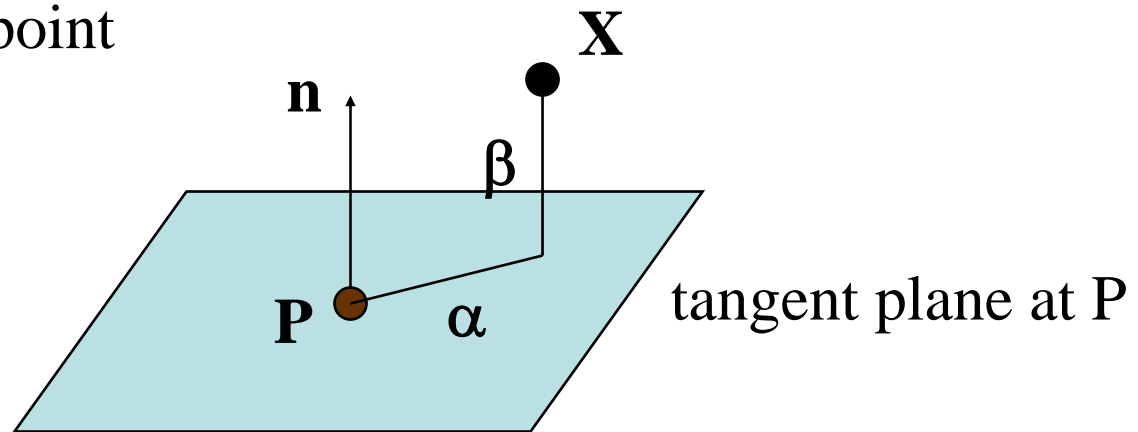

$\alpha$  is the perpendicular distance from  $X$  to  $P$ 's surface normal.

$\beta$  is the signed perpendicular distance from  $X$  to  $P$ 's tangent plane.

# Spin Image Construction

- A spin image is constructed
  - about a specified oriented point  $o$  of the object surface
  - with respect to a set of **contributing points  $C$** , which is controlled by maximum distance and angle from  $o$ .
- It is stored as an array of accumulators  **$S(\alpha, \beta)$**  computed via:
- For each point  $c$  in  $C(o)$ 
  1. compute  $\alpha$  and  $\beta$  for  $c$ .
  2. increment  $S(\alpha, \beta)$

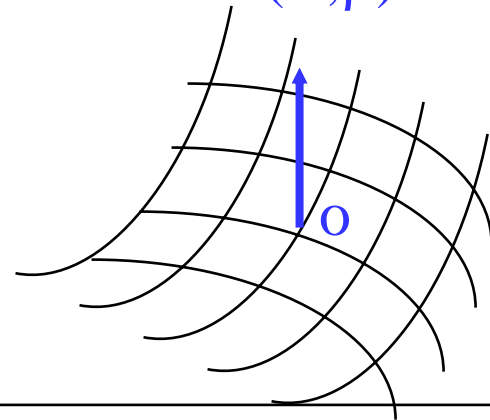

# Spin Image Matching ala Sal Ruiz

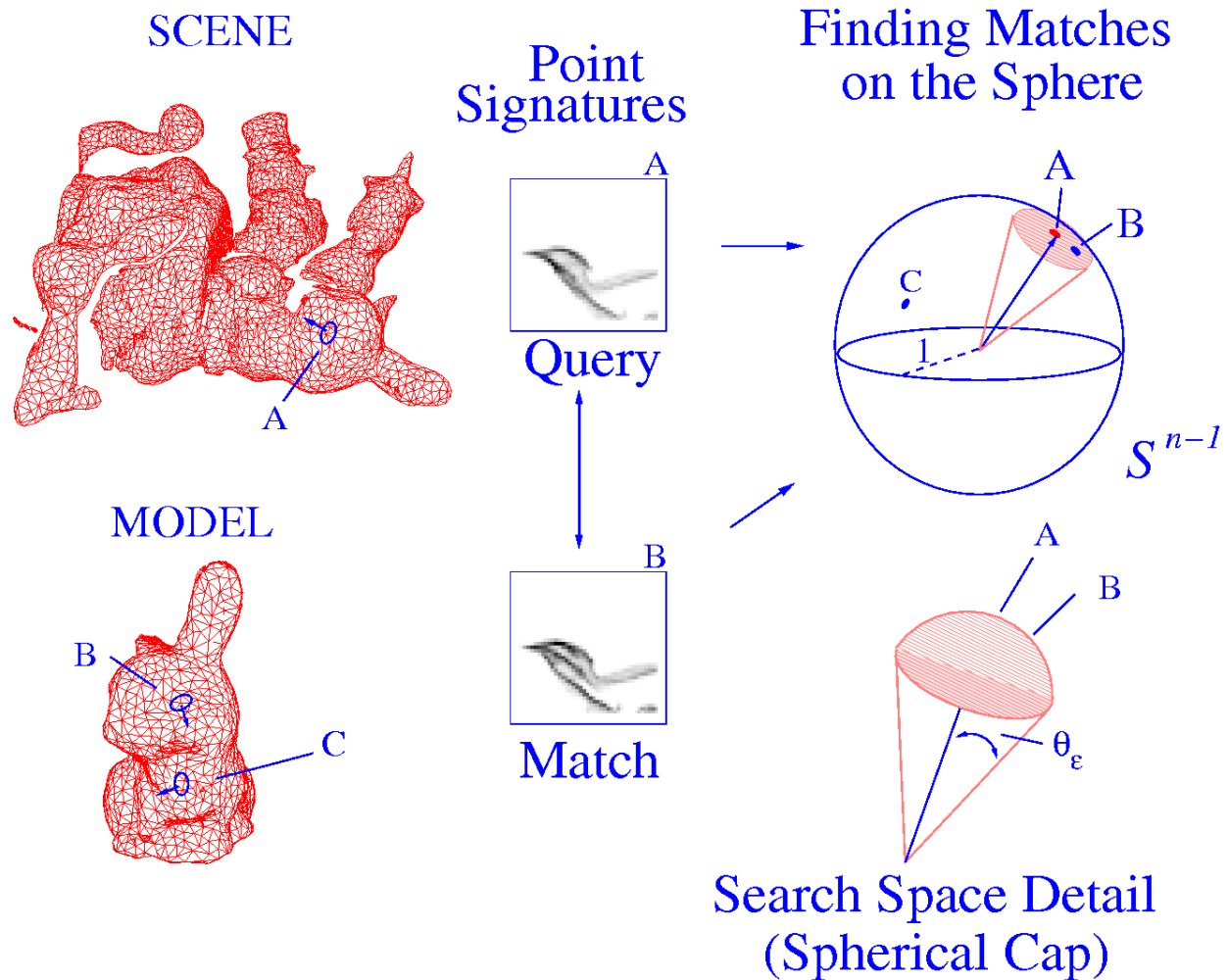



# Spin Images Object Recognition

Offline: Compute spin images of each vertex of the object model(s)

1. Compute spin images at selected points of a scene.
2. Compare scene spin images with model scene images by correlation or related method.
3. Group strong matches as in pose clustering and eliminate outliers.
4. Use the winning pose transformation to align the model to the image points and verify or disprove.

# Sample Data from Johnson & Hebert

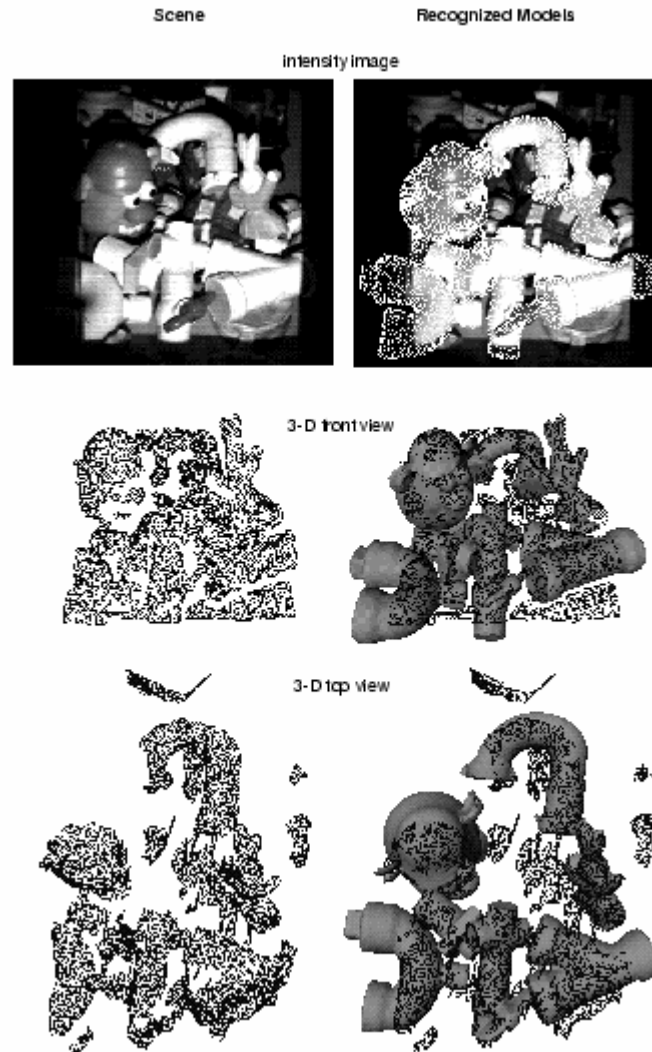

# 2D-3D Alignment

- single 2D images of the objects
- 3D object models
  - full 3D models, such as GC or SEV
  - view class models representing characteristic views of the objects

# View Classes and Viewing Sphere

- The space of view points can be partitioned into a finite set of characteristic views.
- Each view class represents a set of view points that have something in common, such as:
  1. same surfaces are visible
  2. same line segments are visible
  3. relational distance between pairs of them is small

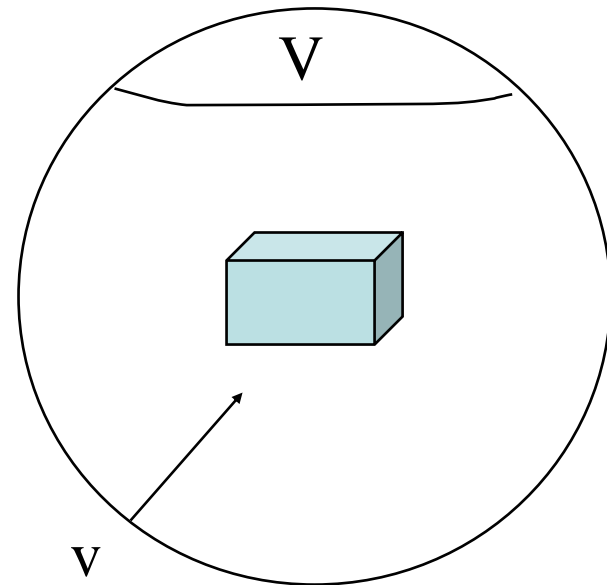

# 3 View Classes of a Cube



1 surface

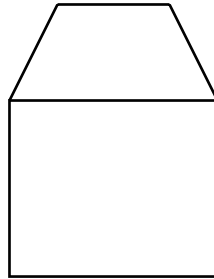

2 surfaces

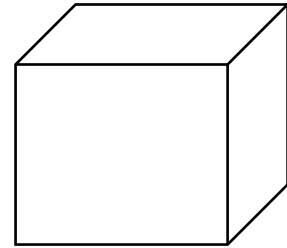

3 surfaces

# TRIBORS: view class matching of polyhedral objects

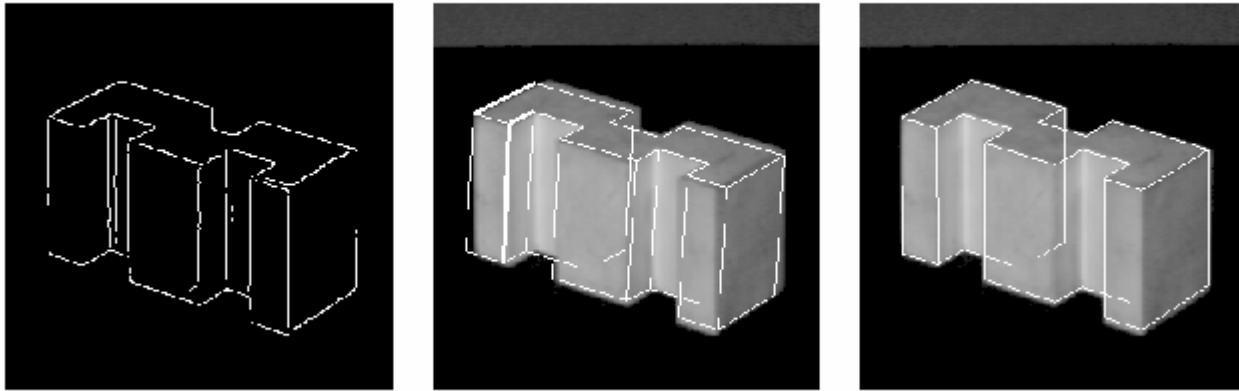

- Each object had 4-5 view classes (hand selected)
- The representation of a view class for matching included:
  - triplets of line segments visible in that class
  - the probability of detectability of each triplet determined by graphics simulation

# RIO: Relational Indexing for Object Recognition

- RIO worked with more complex parts that could have
  - planar surfaces
  - cylindrical surfaces
  - threads

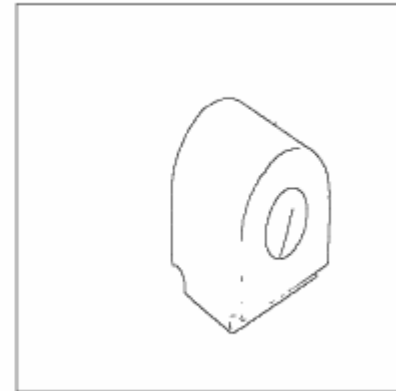
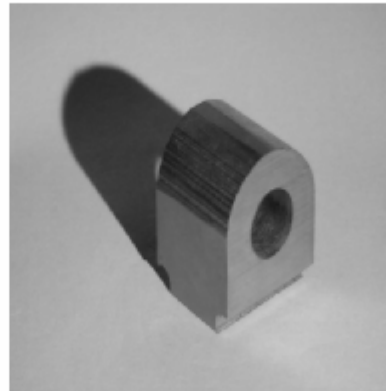
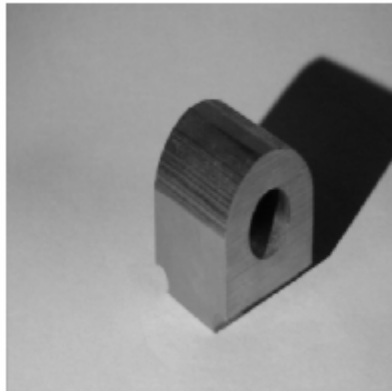

# Object Representation in RIO

- 3D objects are represented by a **3D mesh** and set of **2D view classes**.
- Each **view class** is represented by an **attributed graph** whose nodes are features and whose attributed edges are relationships.
- For purposes of indexing, attributed graphs are stored as sets of **2-graphs**, graphs with 2 nodes and 2 relationships.

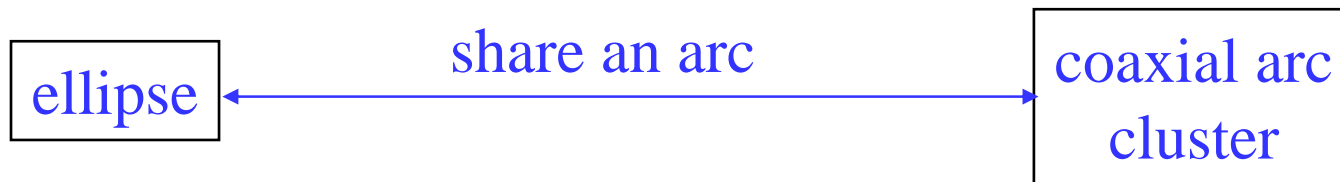



# RIO Features

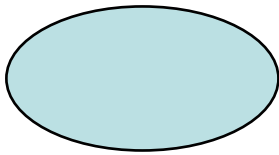

ellipses

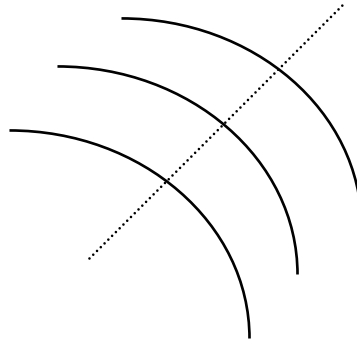

coaxials



coaxials-multi



parallel lines  
close and far



L

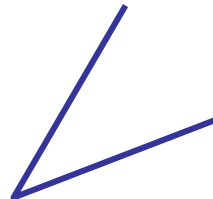

V

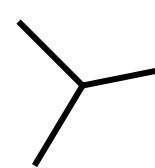

Y



Z

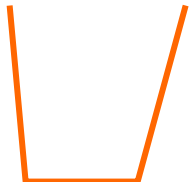

U

junctions

triples

# RIO Relationships

- share one arc
- share one line
- share two lines
- coaxial
- close at extremal points
- bounding box encloses / enclosed by

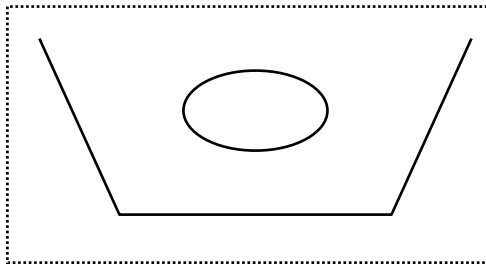
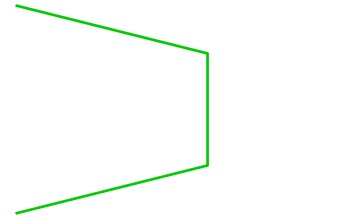

# Hexnut Object

## MODEL-VIEW

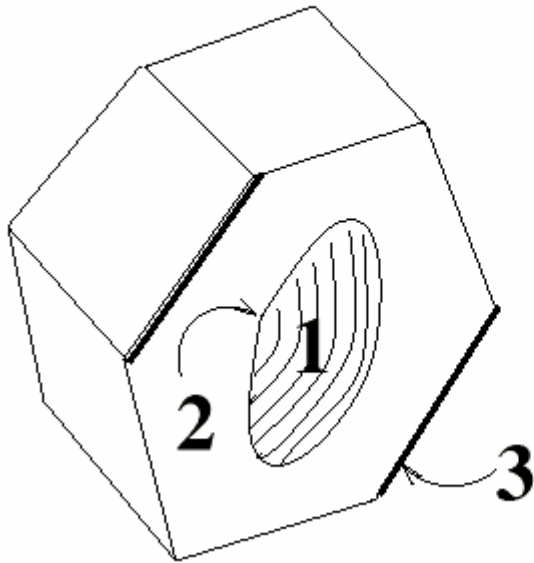

### RELATIONS:

- a: encloses
- b: coaxial

### FEATURES:

- 1: coaxials-multi
- 2: ellipse
- 3: parallel lines

What other features  
and relationships  
can you find?

MODEL-VIEW

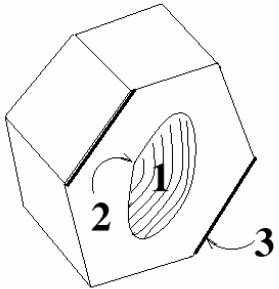

# Graph and 2-Graph Representations

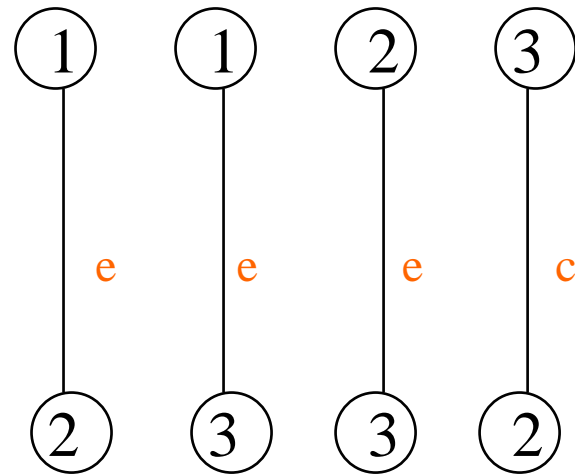
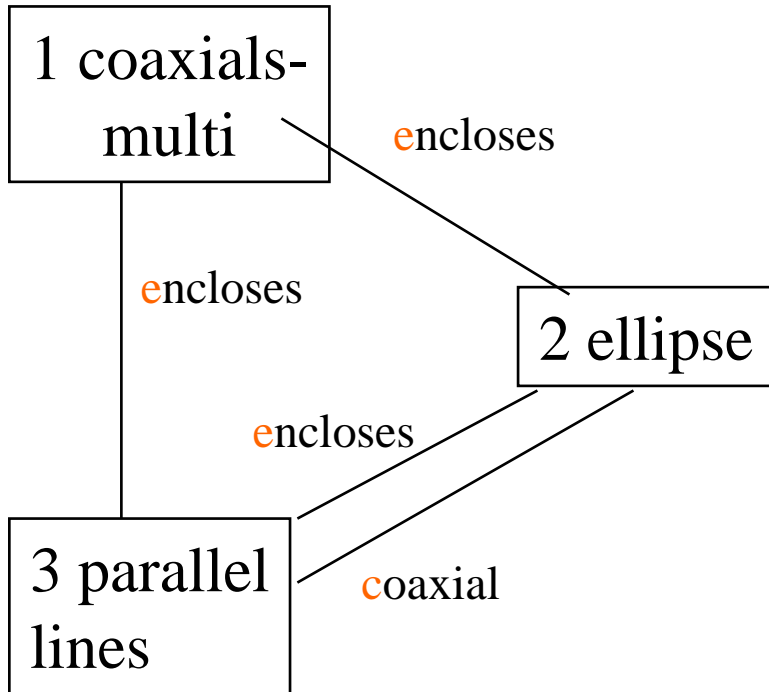

# Relational Indexing for Recognition

## Preprocessing (off-line) Phase

for each model view  $M_i$  in the database

- encode each 2-graph of  $M_i$  to produce an index
- store  $M_i$  and associated information in the indexed bin of a hash table  $H$

# Matching (on-line) phase

1. Construct a relational (2-graph) description  $D$  for the scene
2. For each 2-graph  $G$  of  $D$ 
  - encode it, producing an index to access the hash table  $H$
  - cast a vote for each  $M_i$  in the associated bin
3. Select the  $M_i$ s with high votes as possible hypotheses
4. Verify or disprove via alignment, using the 3D meshes

# The Voting Process

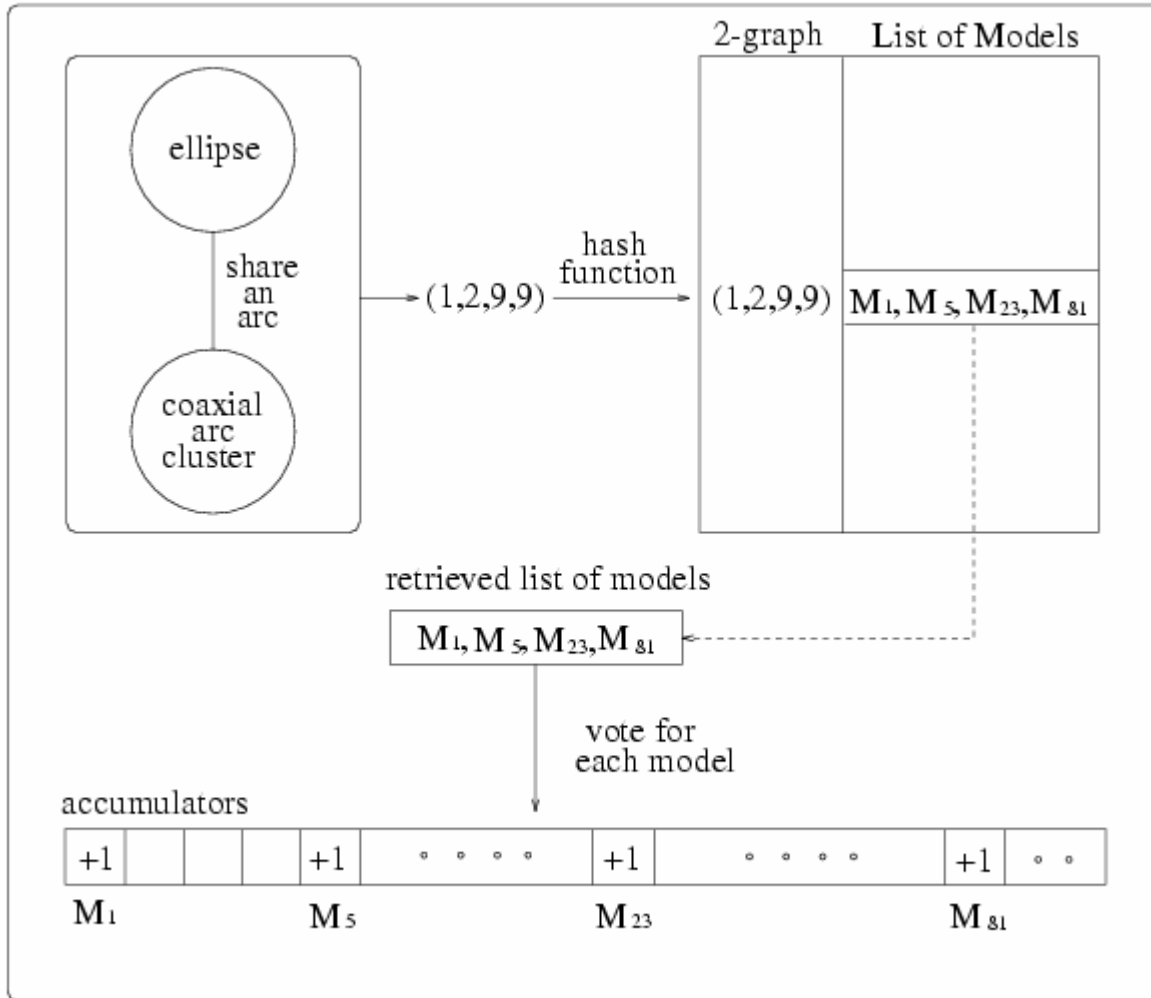

# RIO Verifications

incorrect  
hypothesis

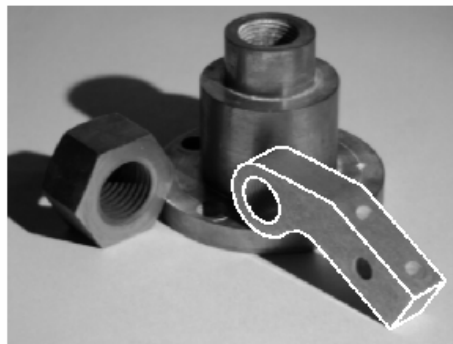
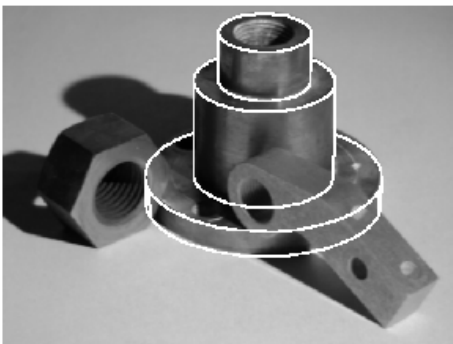
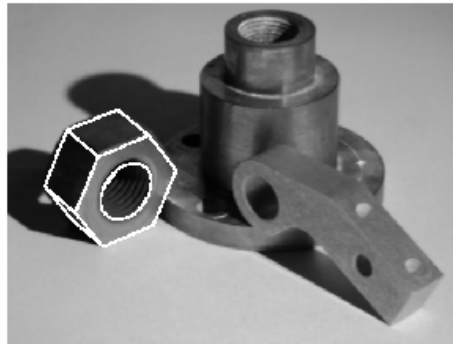
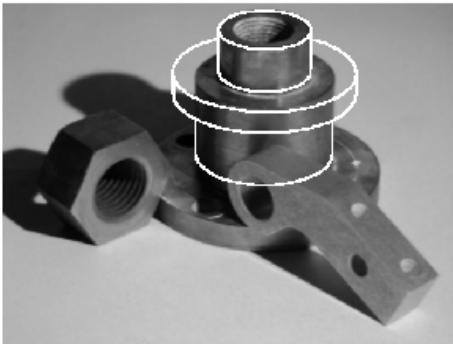

1. The matched features of the hypothesized object are used to determine its **pose**.
2. The **3D mesh** of the object is used to project all its features onto the image.
3. A **verification procedure** checks how well the object features line up with edges on the image.