

Image Stitching II

Linda Shapiro

CSE 455

RANSAC for Homography



Initial Matched Points



RANSAC for Homography



Final Matched Points

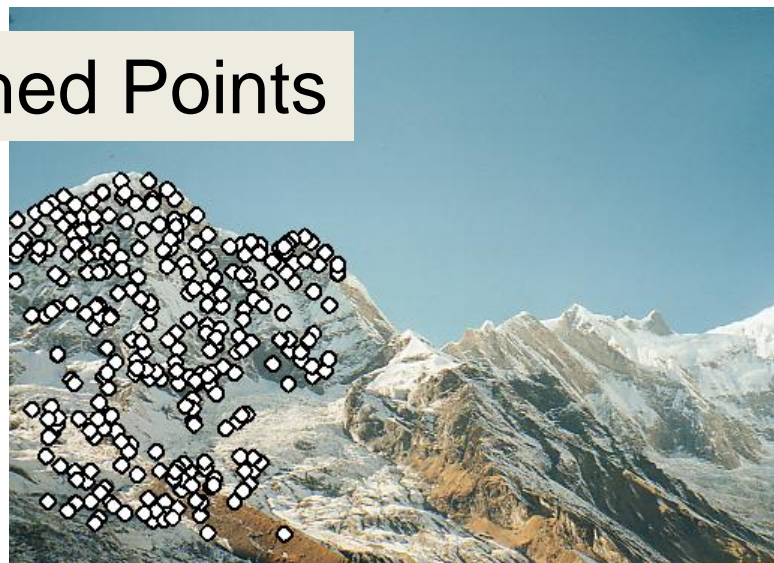
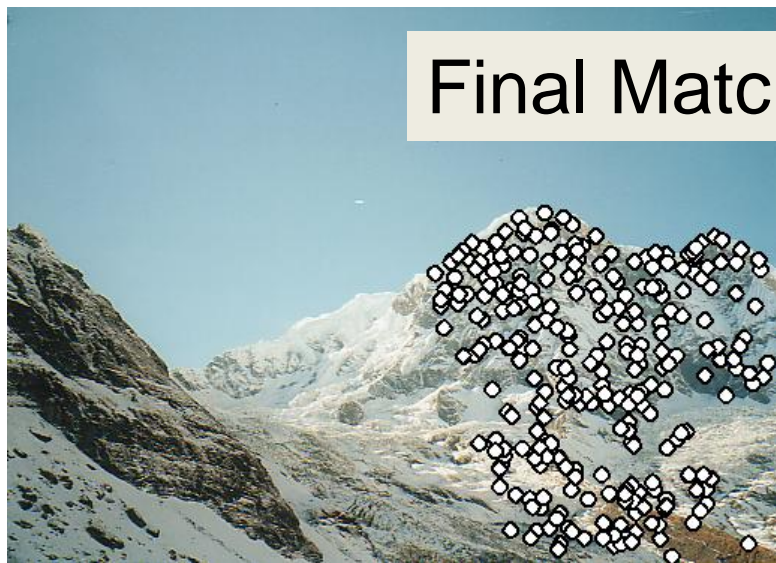

RANSAC for Homography

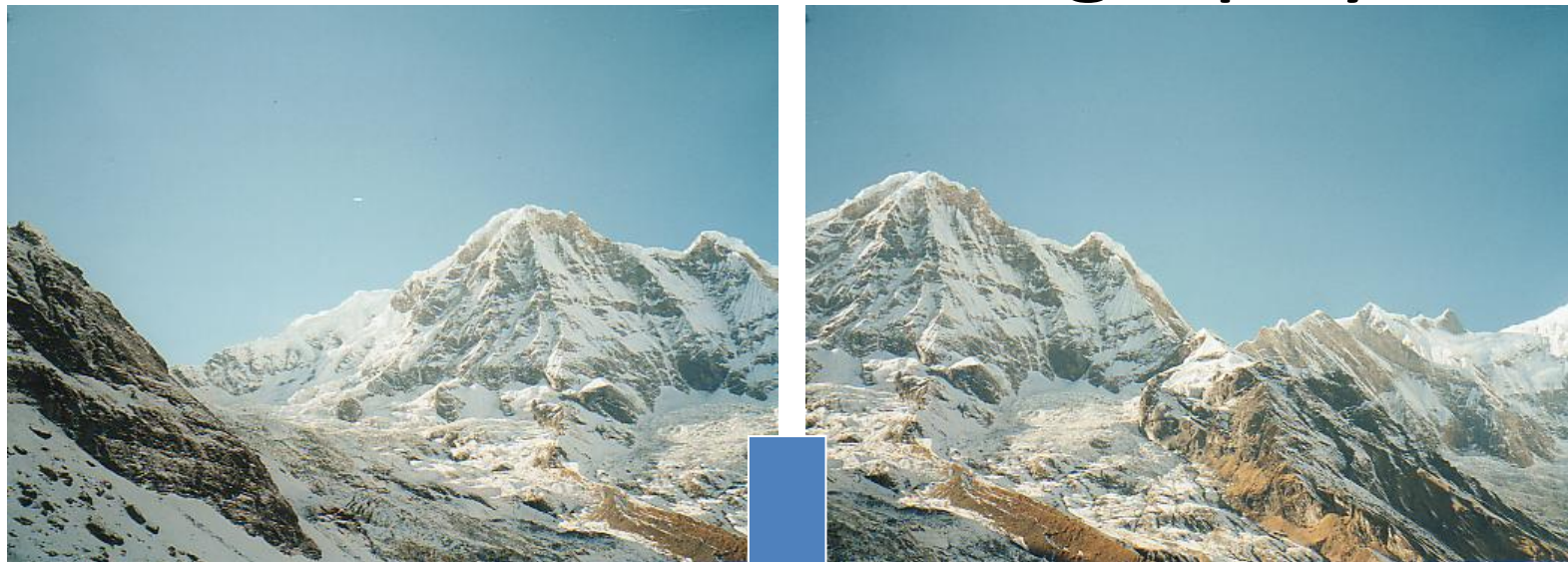
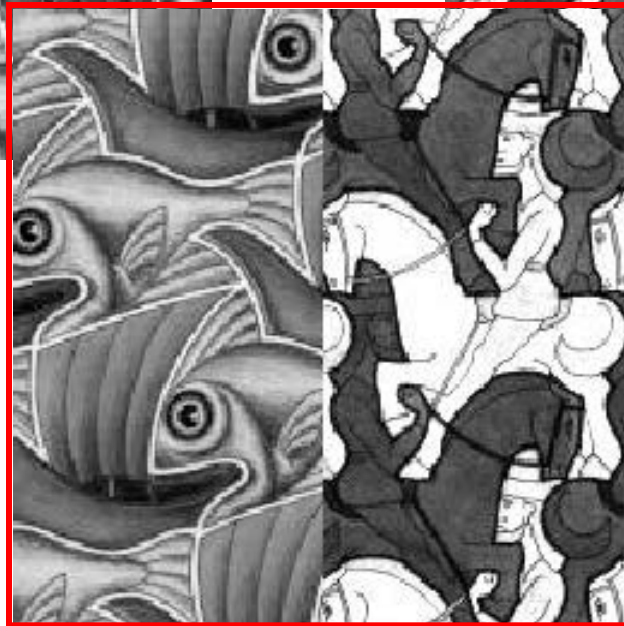
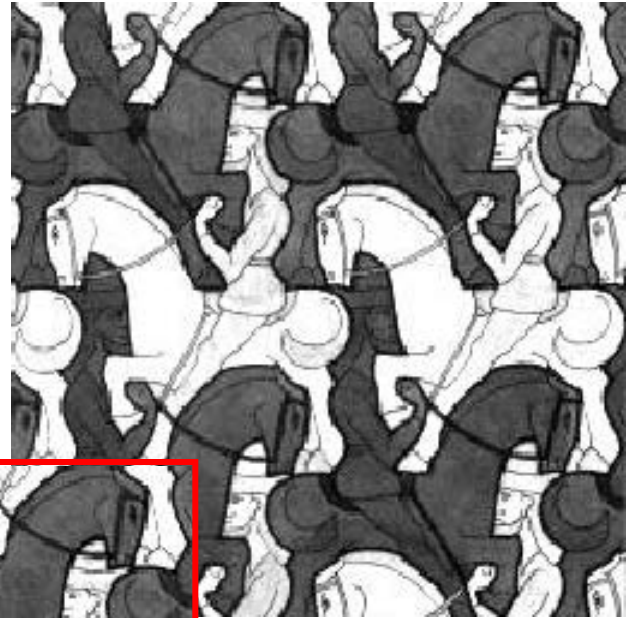
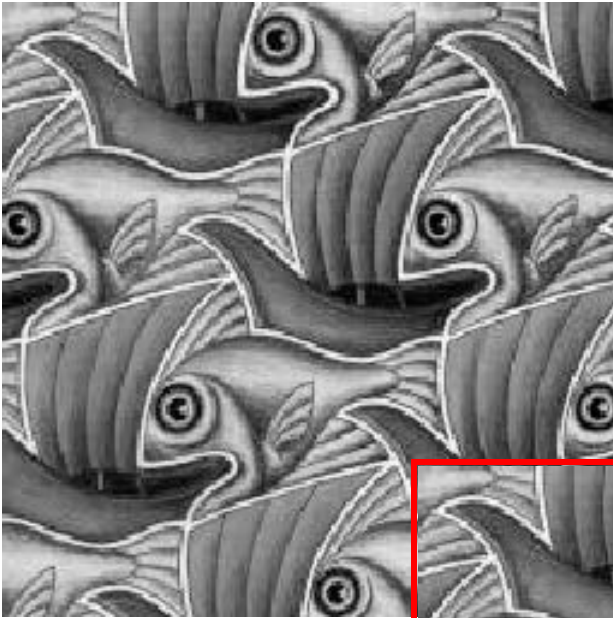
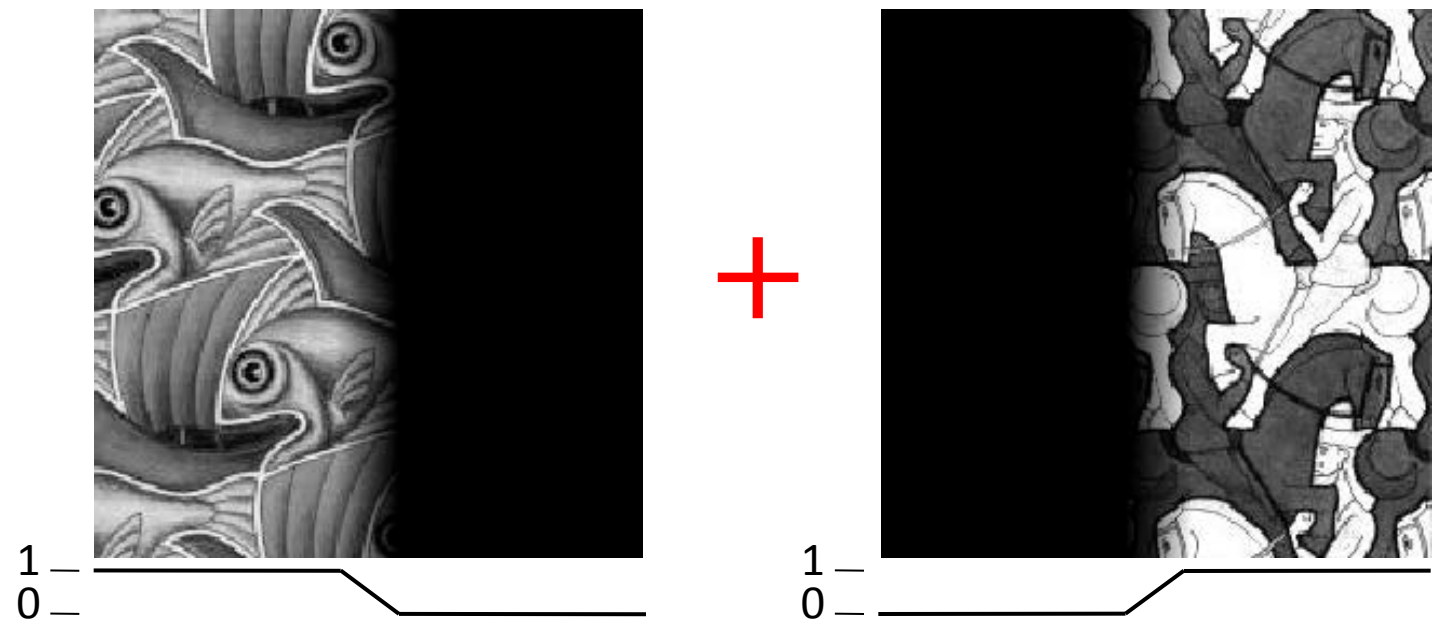

Image Blending



What's wrong?

Feathering



=

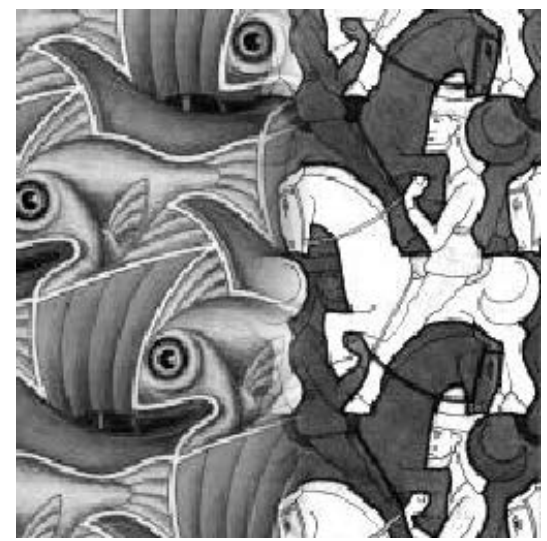

Effect of window (ramp-width) size

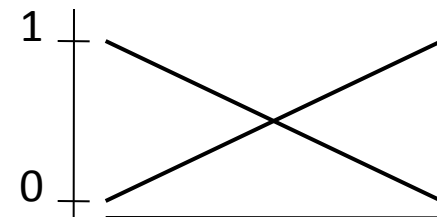
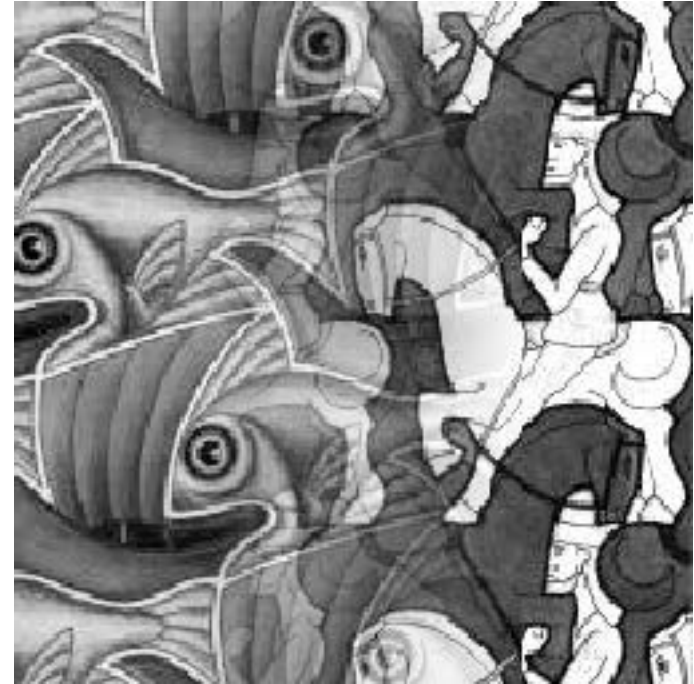
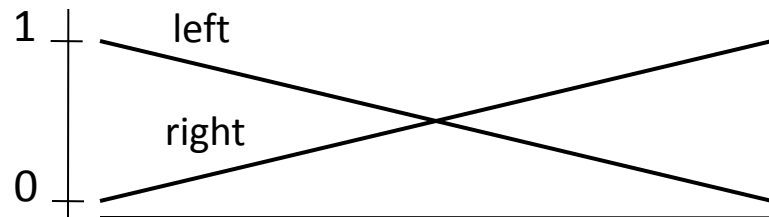
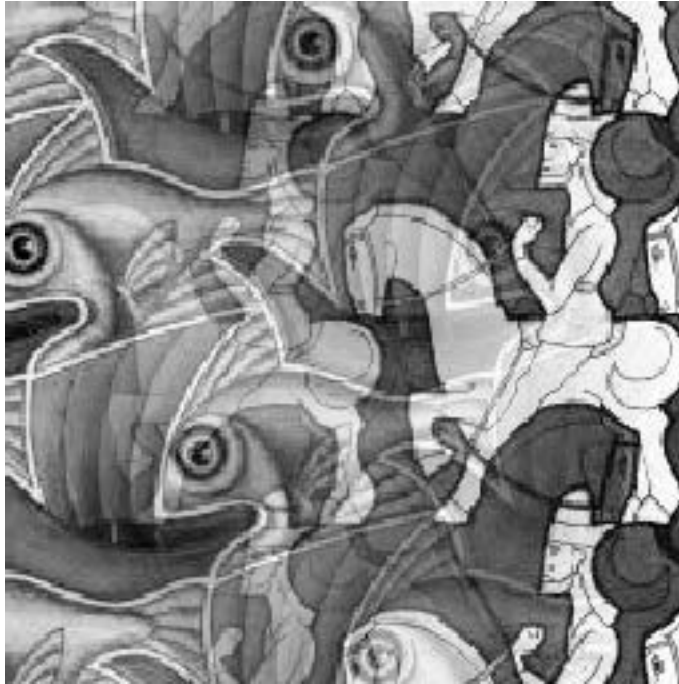

Effect of window size

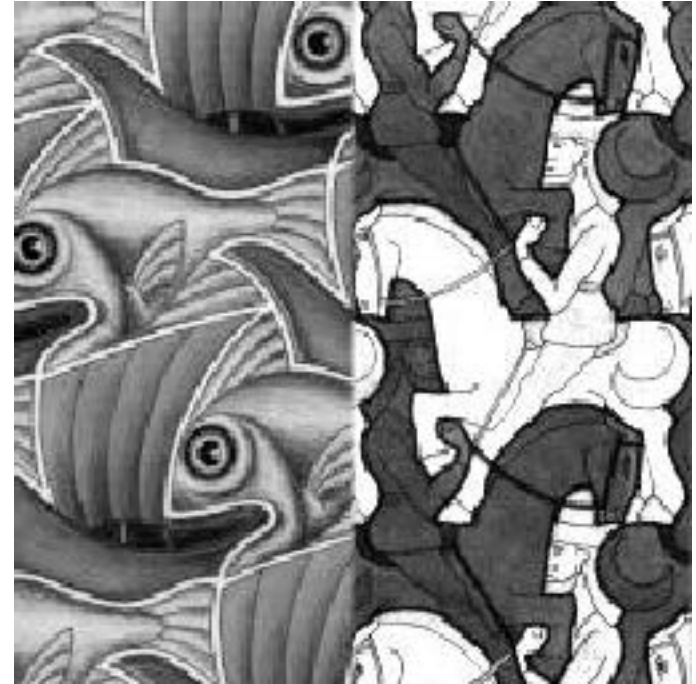
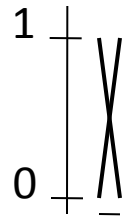
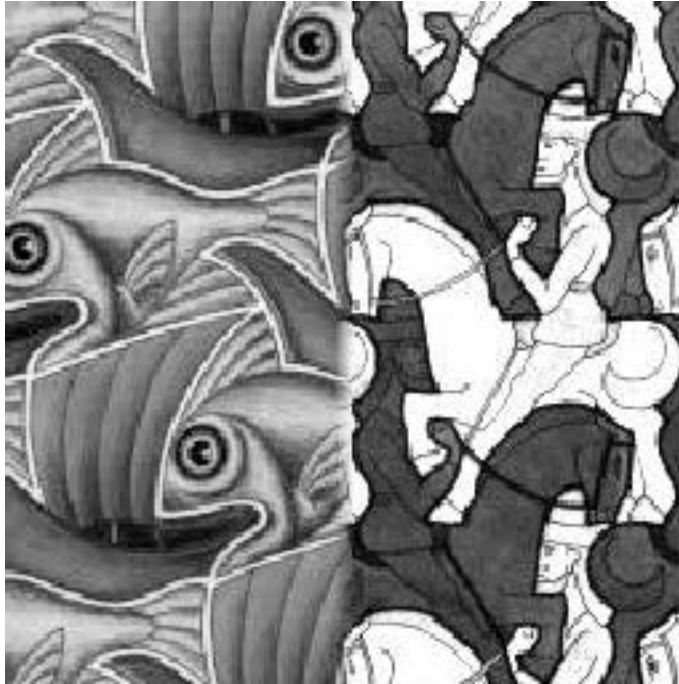

Good window size

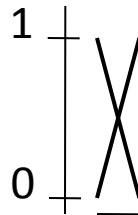

What can we do instead?

“Optimal” window: smooth but not ghosted

- Doesn't always work...

Pyramid blending

apple

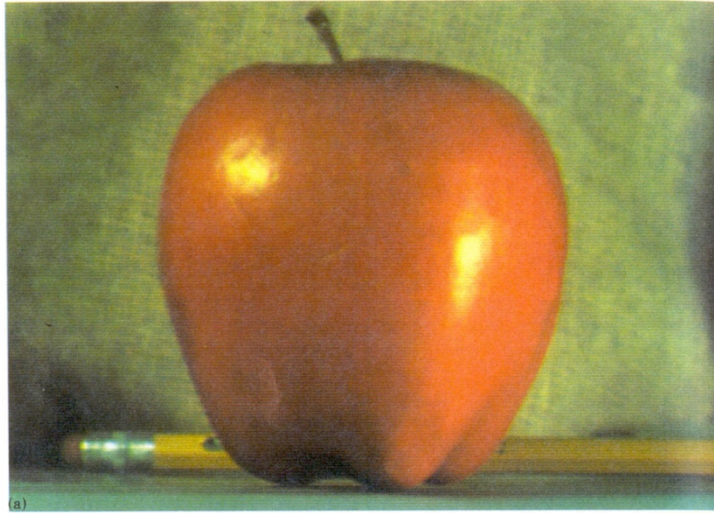

orange

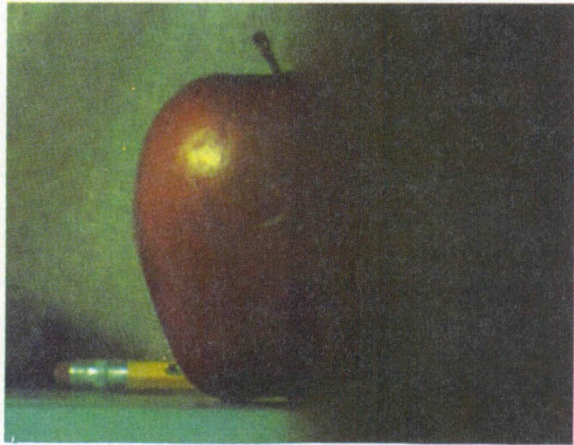
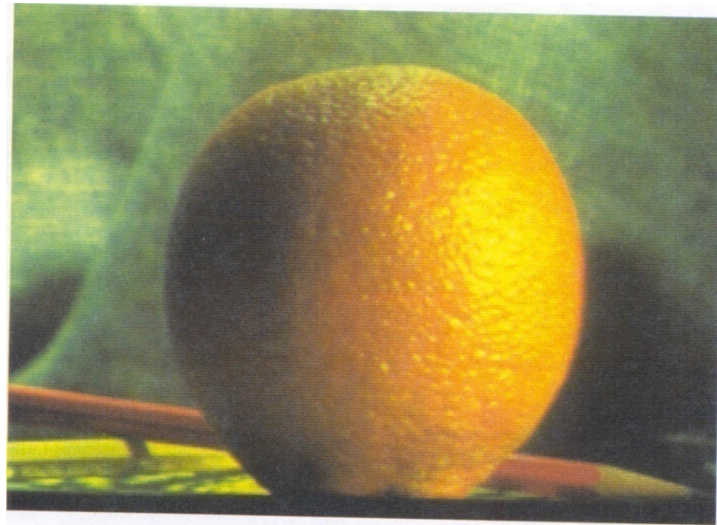

(d)

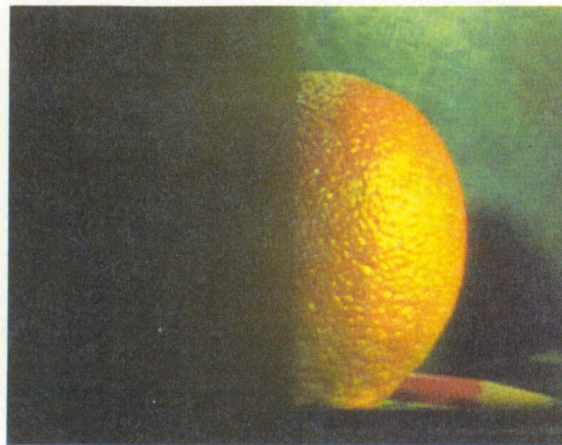

(h)

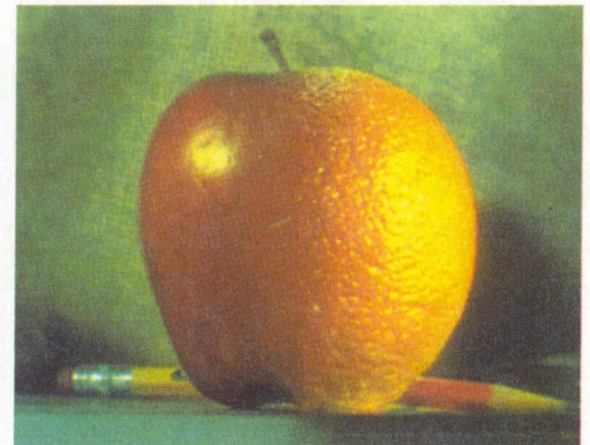

(l)

Create a Laplacian pyramid, blend each level

- Burt, P. J. and Adelson, E. H., A Multiresolution Spline with Application to Image Mosaics, ACM Transactions on Graphics, 42(4), October 1983, 217-236. http://persci.mit.edu/pub_pdfs/spline83.pdf

Forming a Gaussian Pyramid

- Start with the original image G_0
- Perform a local Gaussian weighted averaging function in a neighborhood about each pixel, sampling so that the result is a reduced image of half the size in each dimension.
- Do this all the way up the pyramid

$$G_l = \text{REDUCE}(G_{l-1})$$

- Each level l node will represent a weighted average of a subarray of level l .

Making the Laplacians

- We want to subtract each level of the pyramid from the next lower one.
- But they are different sizes!
- In order to do the subtraction, we perform an interpolation process.
- We interpolate new samples between those of a given image to make it big enough to subtract.
- The operation is called EXPAND.

The Laplacian Pyramid

$$L_i = G_i - \text{expand}(G_{i+1})$$

Gaussian Pyramid

Laplacian Pyramid

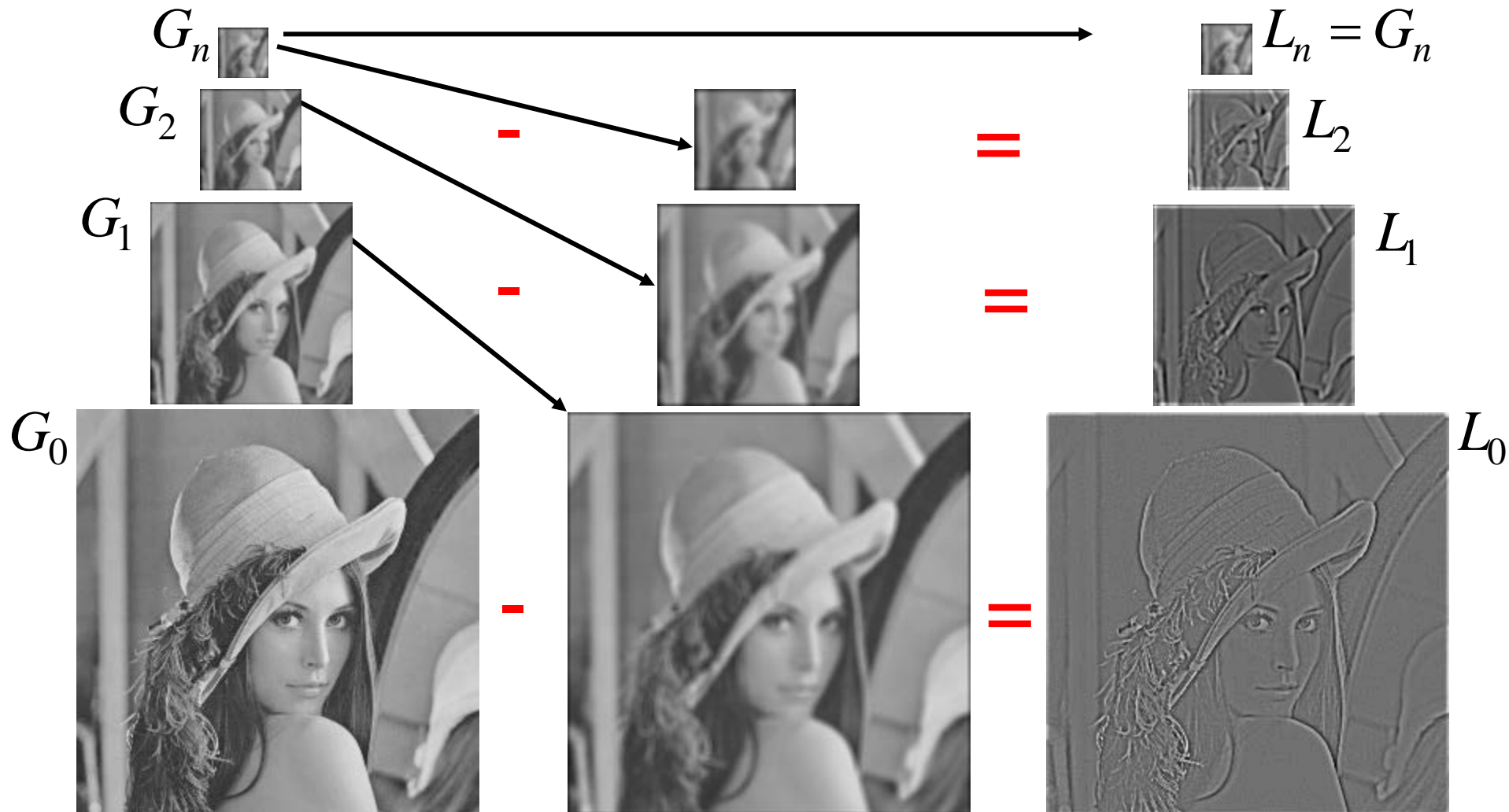

To blend two images, We'll combine two Laplacian pyramids

Laplacian Pyramid LA

Laplacian Pyramid LS
to be filled in

Laplacian Pyramid LB

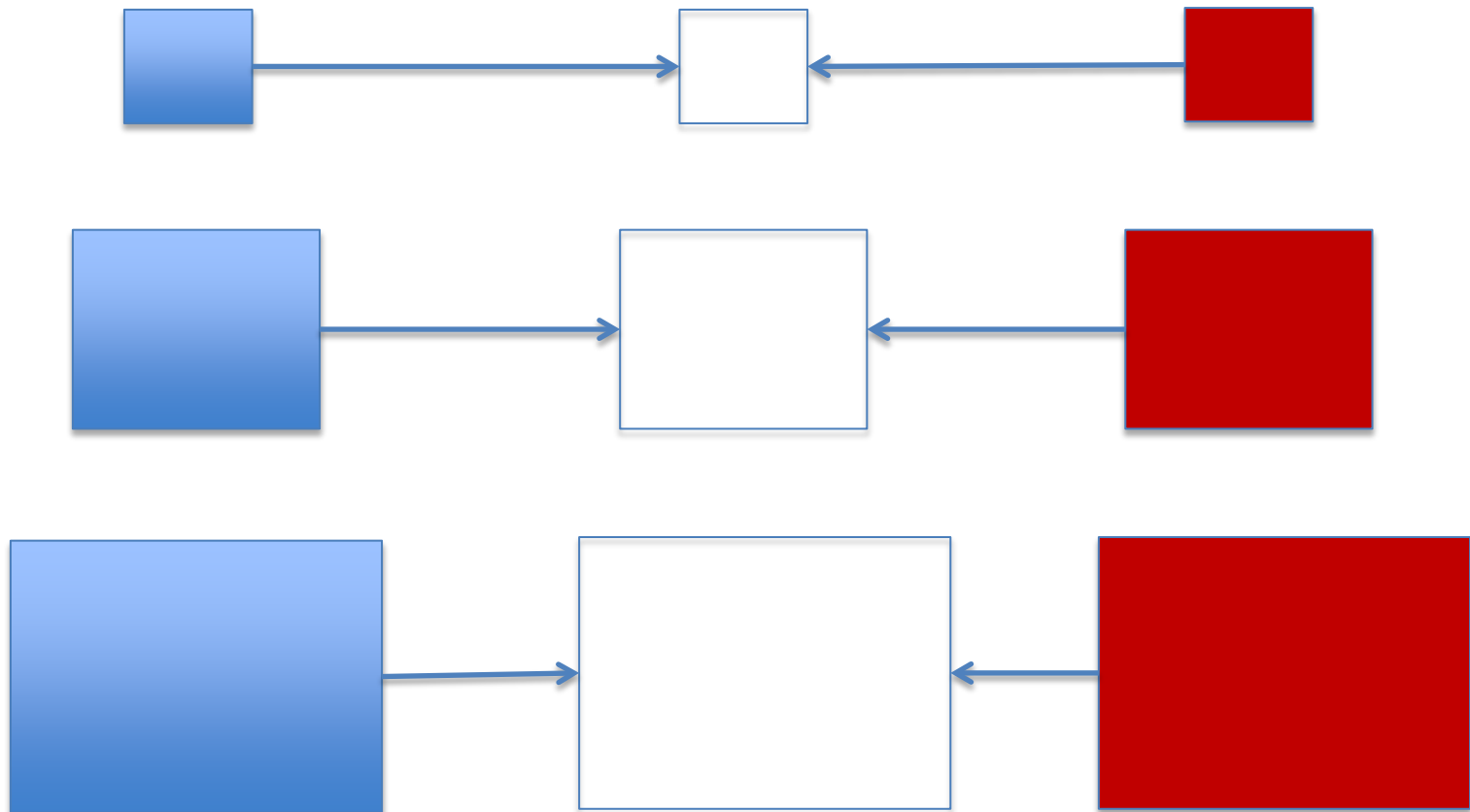

Forming the New Pyramid

- Laplacian pyramids LA and LB are constructed for images A and B, respectively.
- A third Laplacian pyramid LS is constructed by copying nodes from the left half of LA to the corresponding nodes of LS and nodes from the right half of LB to the right half of LS.
- Nodes along the center line are set equal to the average of corresponding LA and LB nodes

Using the new Laplacian Pyramid

- Use the new Laplacian pyramid with the reverse of how it was created to create a Gaussian pyramid.

$$G_i = L_i + \text{expand}(G_{i+1})$$

- The lowest level of the new Gaussian pyramid gives the final result.

Laplacian
level
4

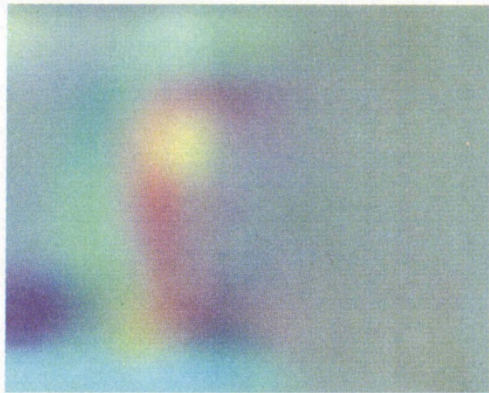

(c)

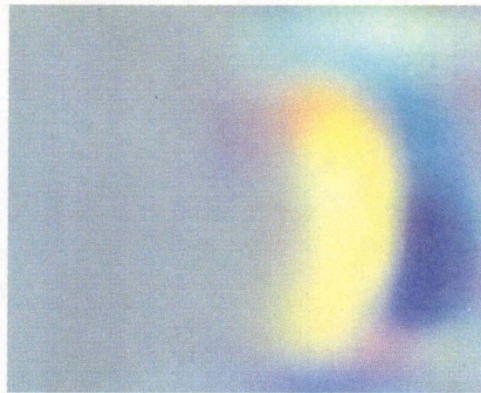

(g)

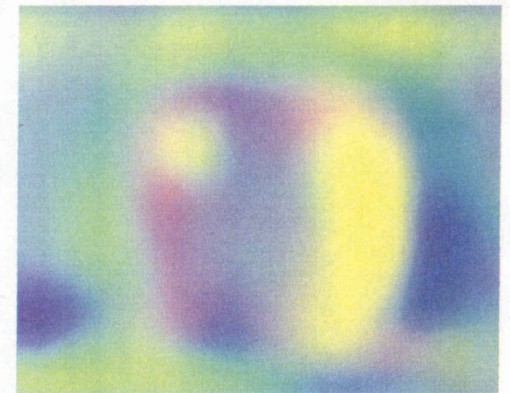

(k)

Laplacian
level
2

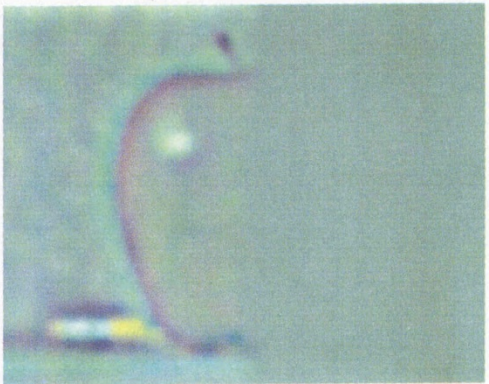

(b)

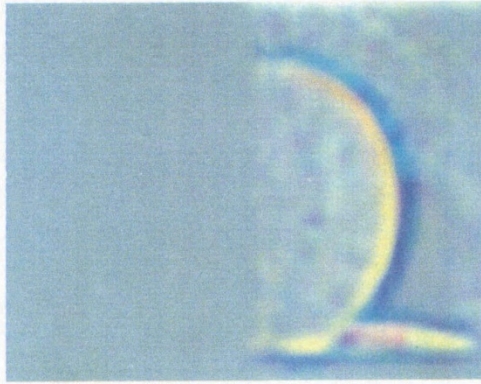

(f)

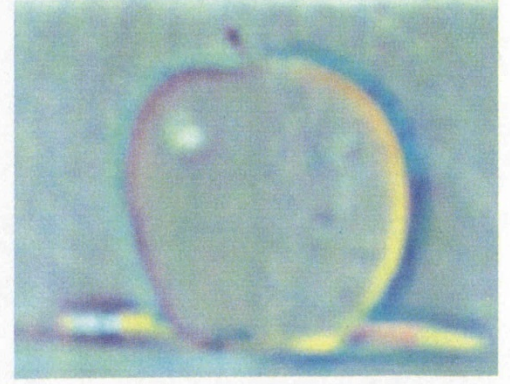

(j)

Laplacian
level
0

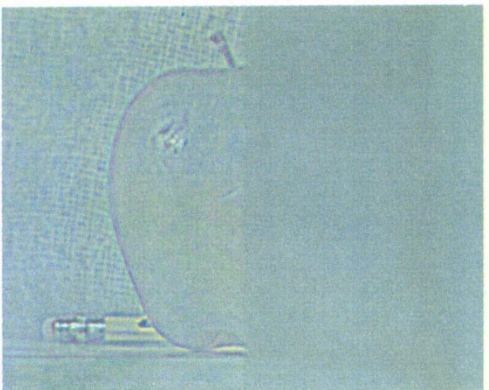

(a)

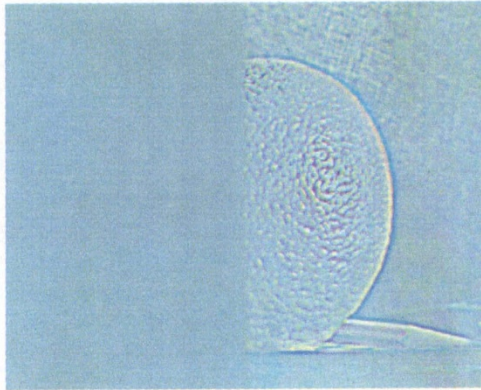

(e)

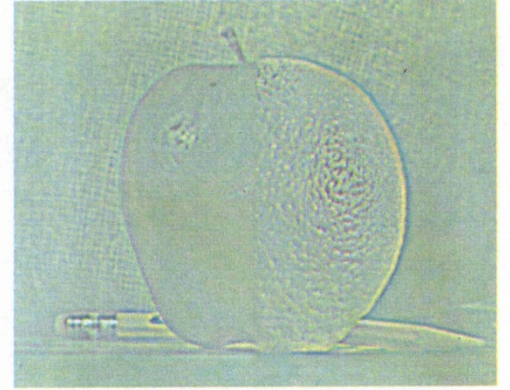

(i)

left pyramid

right pyramid

blended pyramid

Multiband blending (IJCV 2007)

Laplacian pyramids

1. Compute Laplacian pyramid of images and mask
2. Create blended image at each level of pyramid
3. Reconstruct complete image



(a) Original images and blended result

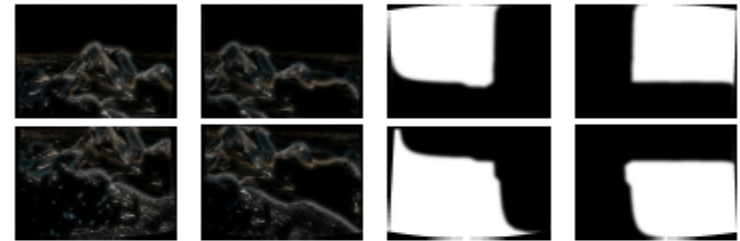

(b) Band 1 (scale 0 to σ)

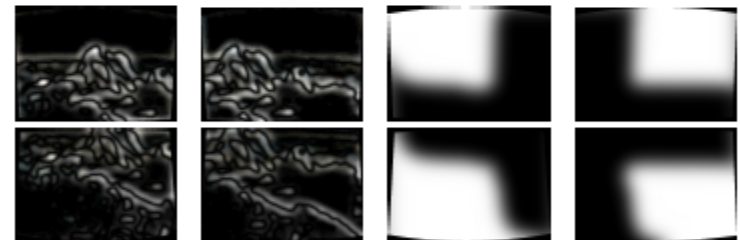

(c) Band 2 (scale σ to 2σ)

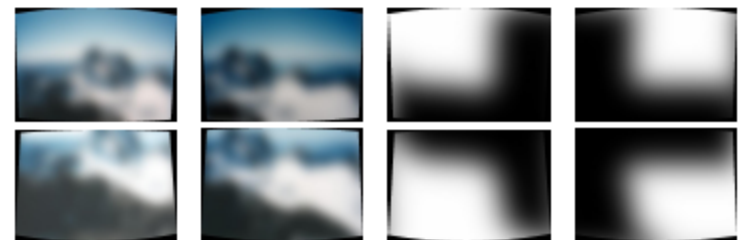

(d) Band 3 (scale lower than 2σ)

Blending comparison (IJCV 2007)



(a) Linear blending



(b) Multi-band blending

Poisson Image Editing



sources/destinations



cloning



seamless cloning

- For more info: Perez et al, SIGGRAPH 2003

– http://research.microsoft.com/vision/cambridge/papers/perez_siggraph03.pdf

Alpha Blending

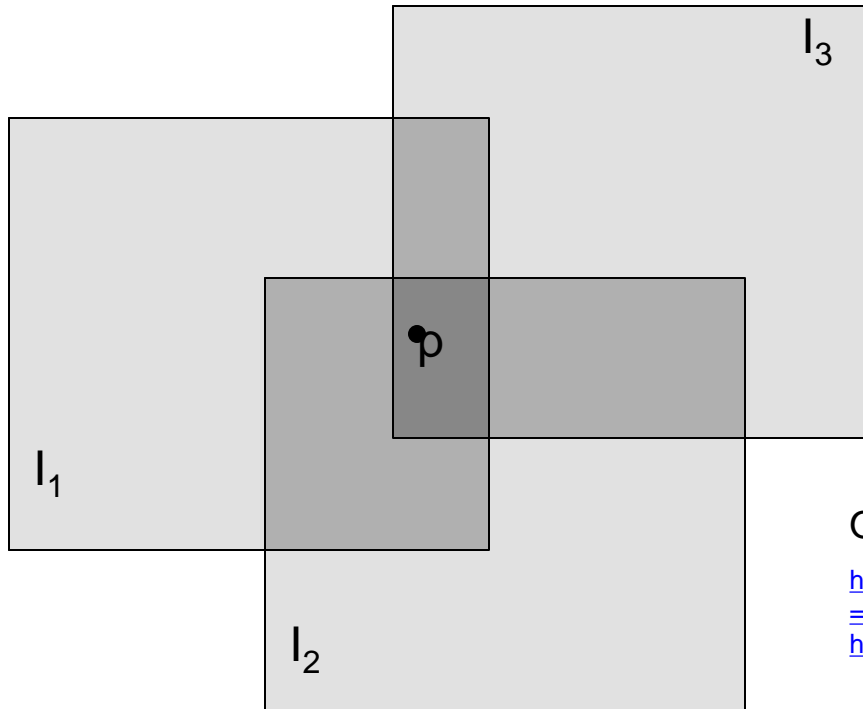

Optional: see Blinn (CGA, 1994) for details:

<http://ieeexplore.ieee.org/iel1/38/7531/00310740.pdf?isNumber=7531&prod=JNL&arnumber=310740&arSt=83&ared=87&arAuthor=Blinn%2C+J.F.>

Encoding blend weights: $I(x,y) = (\alpha R, \alpha G, \alpha B, \alpha)$

color at $p = \frac{(\alpha_1 R_1, \alpha_1 G_1, \alpha_1 B_1) + (\alpha_2 R_2, \alpha_2 G_2, \alpha_2 B_2) + (\alpha_3 R_3, \alpha_3 G_3, \alpha_3 B_3)}{\alpha_1 + \alpha_2 + \alpha_3}$

Implement this in two steps:

1. accumulate: add up the (α premultiplied) RGB values at each pixel
2. normalize: divide each pixel's accumulated RGB by its α value

Choosing Seams: Where do we stitch?

- Easy method
 - Assign each pixel to image with nearest center

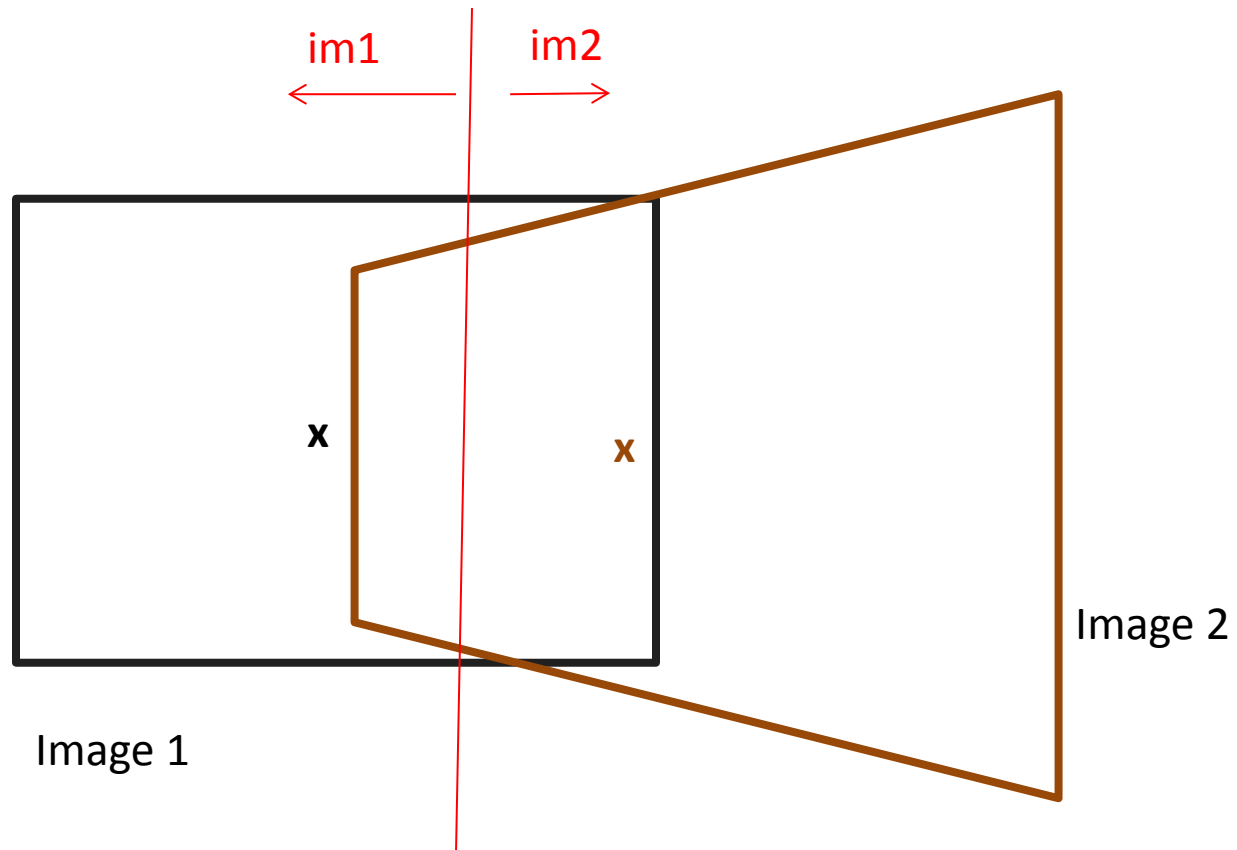

Choosing seams

- Easy method
 - Assign each pixel to image with nearest center
 - Create a mask:
 - Smooth boundaries (“feathering”):
 - Composite

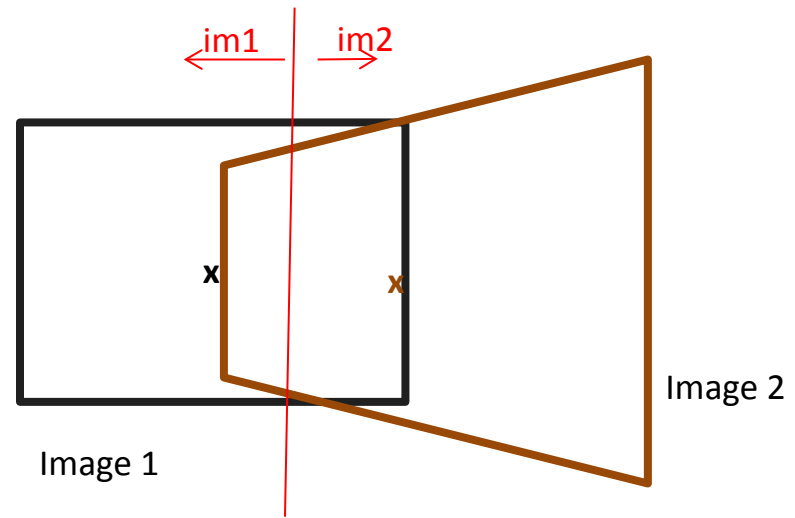

Choosing seams

- Better method: dynamic program to find seam along well-matched regions

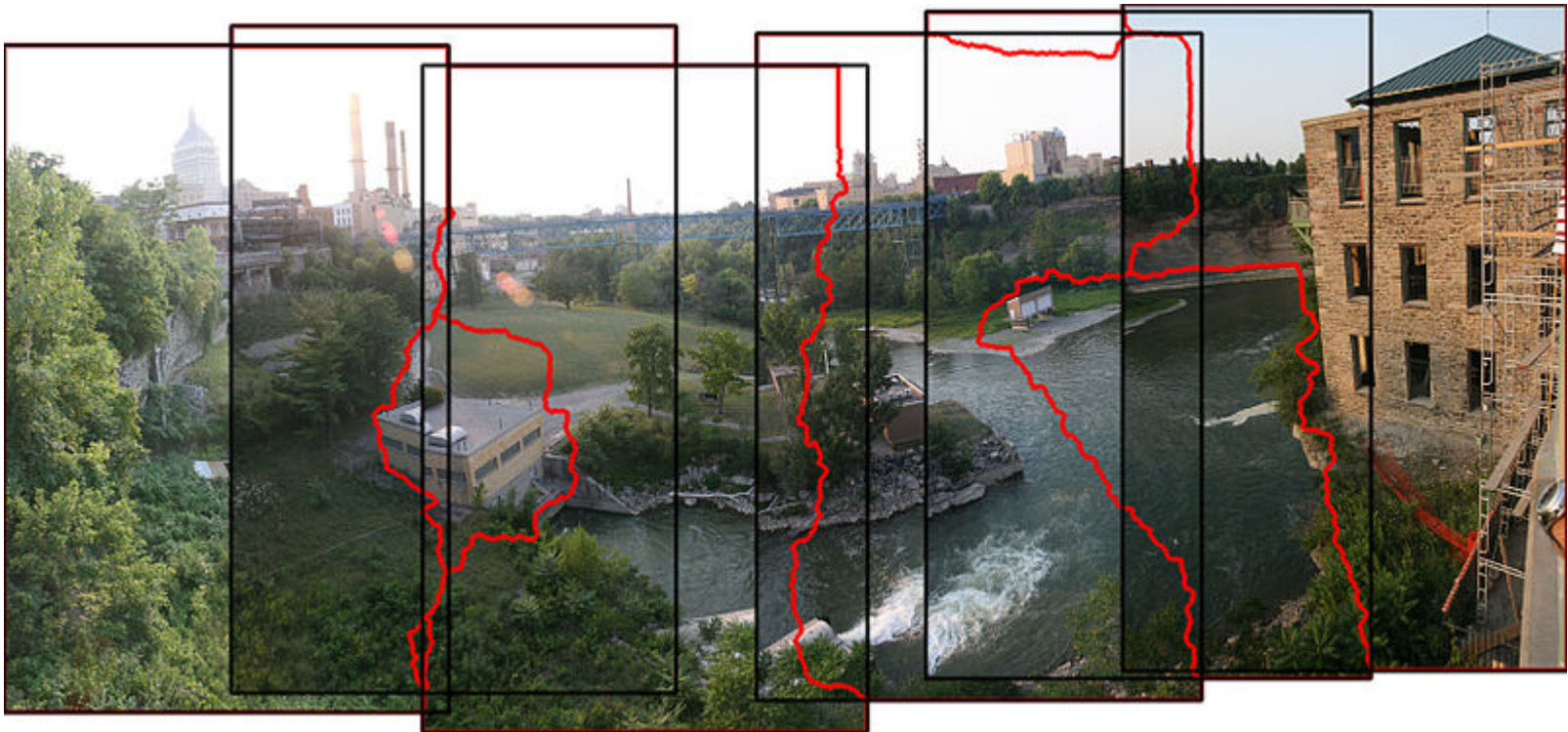

Gain Compensation: Getting rid of artifacts

- Simple gain adjustment
 - Compute average RGB intensity of each image in overlapping region
 - Normalize intensities by ratio of averages



Blending Comparison



(b) Without gain compensation



(c) With gain compensation



(d) With gain compensation and multi-band blending

Recognizing Panoramas

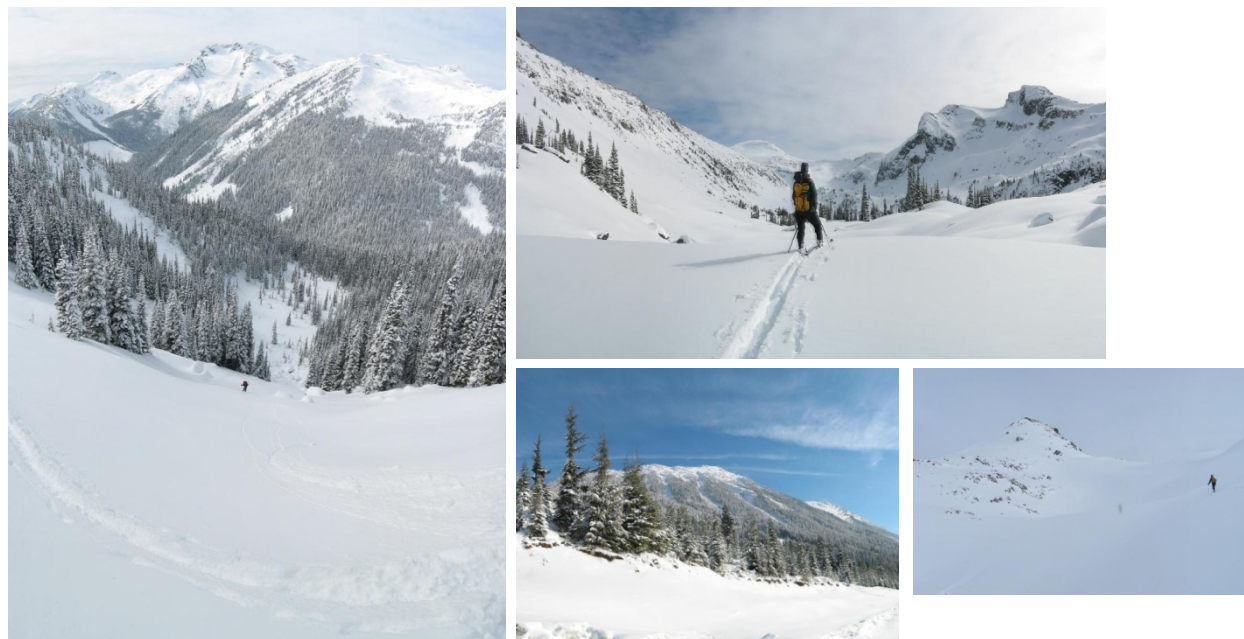
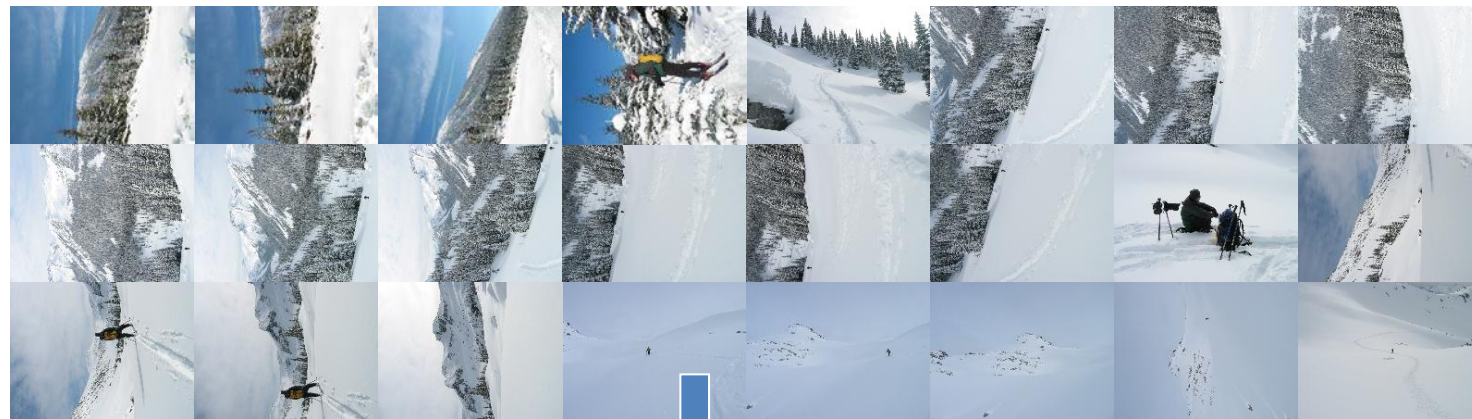

Recognizing Panoramas

Input: N images

1. Extract SIFT points, descriptors from all images
2. Find K-nearest neighbors for each point (K=4)
3. For each image
 - a) Select M candidate matching images by counting matched keypoints (m=6)
 - b) Solve homography \mathbf{H}_{ij} for each matched image

Recognizing Panoramas

Input: N images

1. Extract SIFT points, descriptors from all images
2. Find K-nearest neighbors for each point (K=4)
3. For each image
 - a) Select M candidate matching images by counting matched keypoints (m=6)
 - b) Solve homography \mathbf{H}_{ij} for each matched image
 - c) Decide if match is valid ($n_i > 8 + 0.3 n_f$)

inliers

keypoints in overlapping area

Recognizing Panoramas (cont.)

(now we have matched pairs of images)

4. Make a graph of matched pairs

Find connected components of the graph

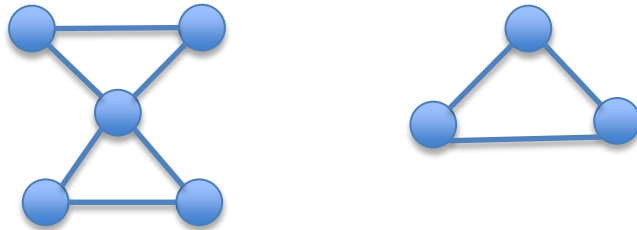

Finding the panoramas

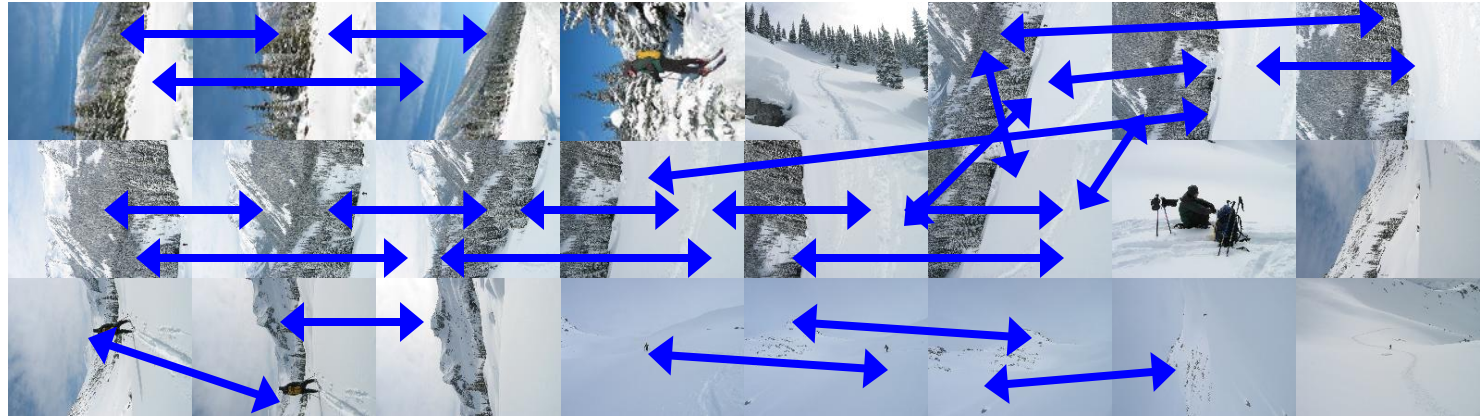

Finding the panoramas

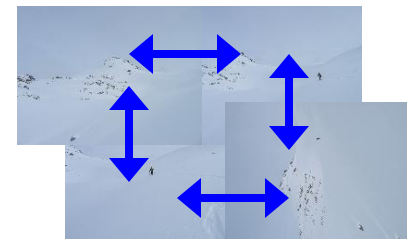
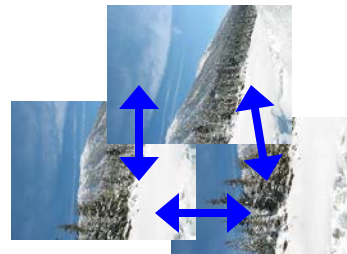
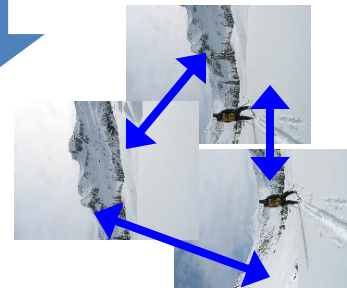
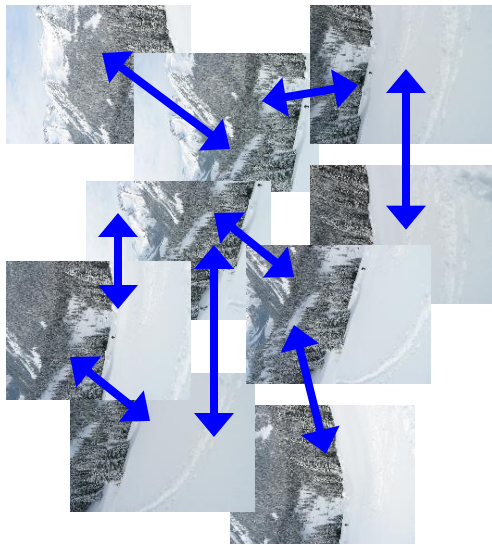
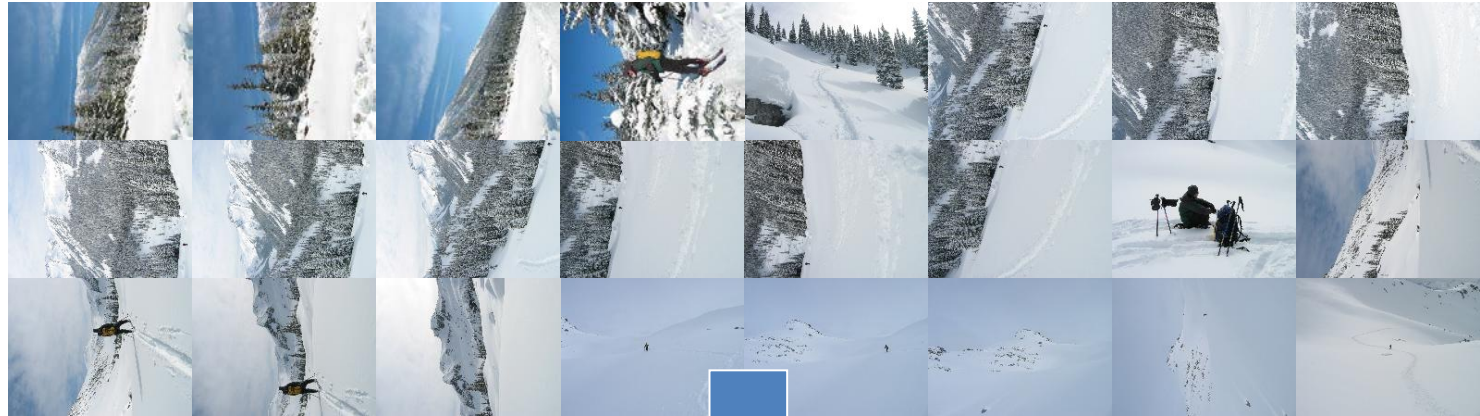

Recognizing Panoramas (cont.)

(now we have matched pairs of images)

4. Find connected components
5. For each connected component
 - a) Solve for rotation and f
 - b) Project to a surface (plane, cylinder, or sphere)
 - c) Render with multiband blending

Finding the panoramas

