

Animation principles

1

Reading

Required:

- ♦ John Lasseter. Principles of traditional animation applied to 3D computer animation. Proceedings of SIGGRAPH (Computer Graphics) 21(4): 35-44, July 1987.

Recommended:

- ♦ Frank Thomas and Ollie Johnston, Disney animation: The Illusion of Life, Hyperion, 1981.

2

Character animation

Goal: make characters that move in a convincing way to communicate personality and mood.

Walt Disney developed a number of principles.

Computer graphics animators have adapted them to 3D animation.

3

Animation Principles

The following are a set of principles to keep in mind:

1. Squash and stretch
2. Staging
3. Timing
4. Anticipation
5. Follow through
6. Overlapping action
7. Secondary action
8. Straight-ahead vs. pose-to-pose vs. blocking
9. Arcs
10. Slow in, slow out
11. Exaggeration
12. Appeal

We will consider each...

4

Squash and stretch

Squash: flatten an object or character by pressure or by its own power.

Stretch: used to increase the sense of speed and emphasize the squash by contrast.

Note: keep volume constant!

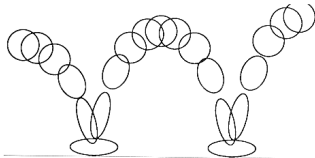

FIGURE 2. Squash & stretch in bouncing ball.

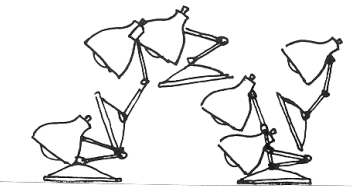

FIGURE 3. Squash & stretch in Luxo Jr.'s hop.

5

Squash and stretch (cont'd)

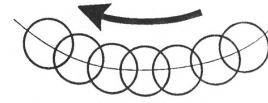

FIGURE 4a. In slow action, an object's position overlaps from frame to frame which gives the action a smooth appearance to the eye.

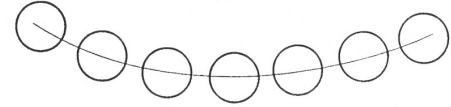

FIGURE 4b. Strobing occurs in a faster action when the object's positions do not overlap and the eye perceives separate images.

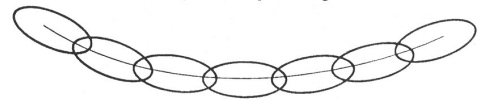
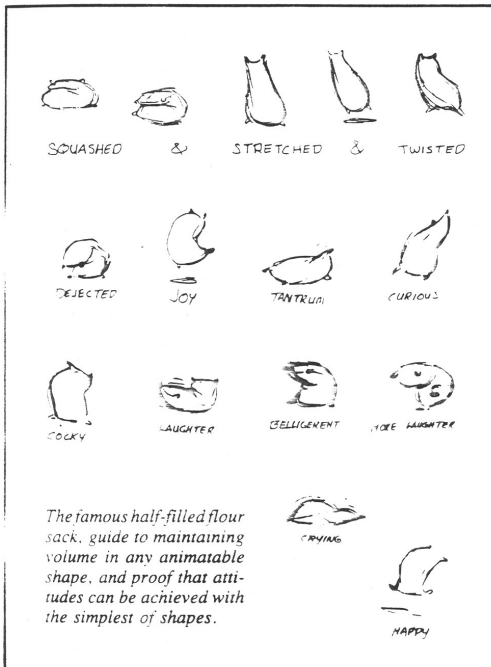

FIGURE 4c. Stretching the object so that its positions overlap again will relieve the strobing effect.

6

Squash and stretch (cont'd)



7

Squash and stretch (cont'd)

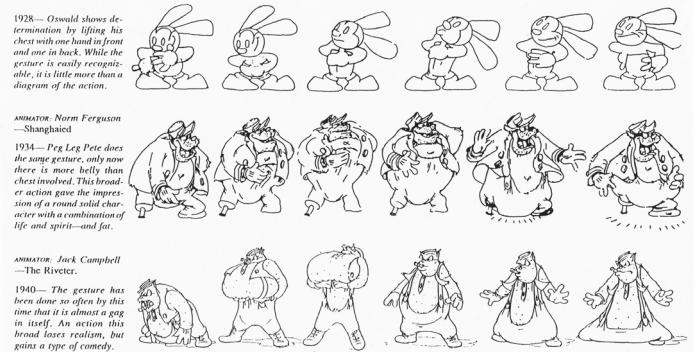

8

Squash and stretch (cont'd)

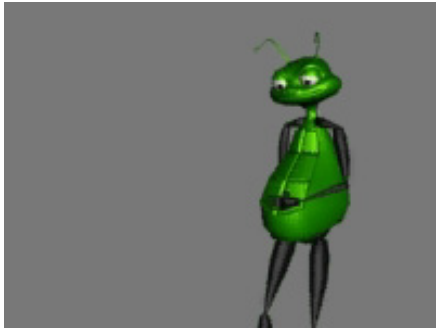
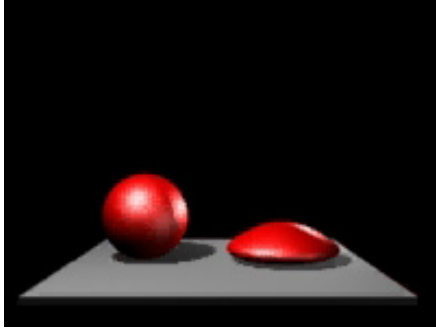

9

Staging

Present the idea so it is unmistakably clear.

Audience can only see one thing at a time.

Useful guide: stage actions in silhouette.

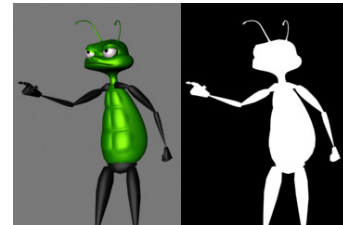
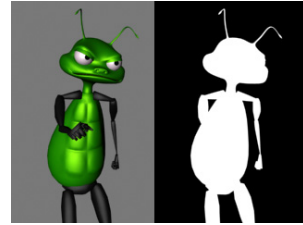

In dialogue, characters face 3/4 towards the camera, not right at each other.

10

Timing

An action generally consists of anticipation, the action, and the reaction. Don't dwell too long on any of these.

Timing also reflects the weight of an object:

- ♦ light objects move quickly
- ♦ heavier objects move more slowly

Timing can completely change the meaning of an action.

11

Timing (cont'd)

The many meanings of a simple head turn:

NO inbetweens	hit by a tremendous force.
ONE inbetween	hit by a brick, frying pan.
TWO inbetweens	nervous tic, muscle spasm.
THREE inbetweens	dodging a thrown brick.
FOUR inbetweens	giving a crisp order (move it!)
FIVE inbetweens	a more friendly order (c'mon!)
SIX inbetweens	sees a sportscar he always wanted
SEVEN inbetweens	trying to get a better look...
EIGHT inbetweens	searching for something on shelf
NINE inbetweens	considering thoughtfully
TEN inbetweens	stretching a sore muscle

12

Anticipation

An action has three parts: anticipation, action, reaction.

Anatomical motivation: a muscle must extend before it can contract.

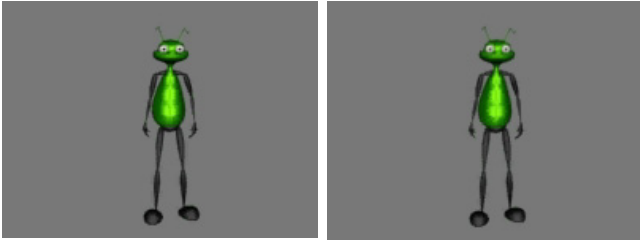

Prepares audience for action so they know what to expect.

Directs audience's attention.

13

Anticipation (cont'd)

Amount of anticipation (combined with timing) can affect perception of speed or weight.



14

Follow through

Actions seldom come to an abrupt stop.

Physical motivation: inertia

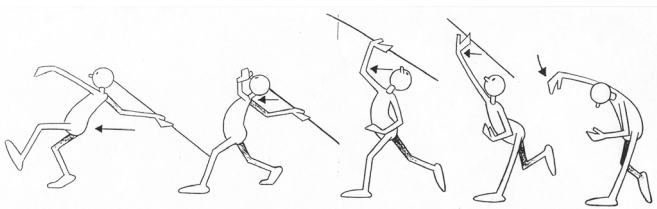

15

Follow through (cont'd)

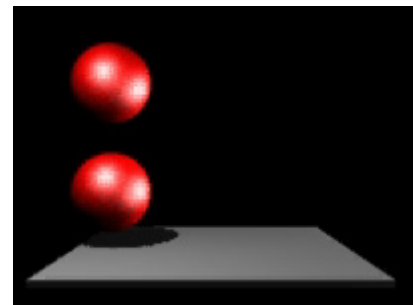

16

Overlapping and secondary action

Overlapping action

One part initiates ("leads") the move. Others follow in turn.

Hip leads legs, but eyes often lead the head.

Loose parts move slower and drag behind.

Overlaps apply to intentions. Example: settling into the house at night.

- ♦ Close the door
- ♦ Lock the door
- ♦ Take off the coat
- ♦ etc...

Each action doesn't come to a complete finish before the next starts.

Secondary action

An action that emphasizes the main point but is secondary to it.

17

Straight-ahead vs. pose-to-pose vs. blocking

Straight ahead: proceed from frame to frame without planning where you want to be in ten frames. Can be wild, spontaneous.

Pose-to-pose: Define keyframes and "inbetweens".

Blocking: Computer graphics animators adaptation

- ♦ Start key-framing at the top of the hierarchy.
- ♦ Refine level by level.
- ♦ Keyframes for different parts need not happen at the same time.

18

Arcs

Avoid straight lines since most things in nature move in arcs.

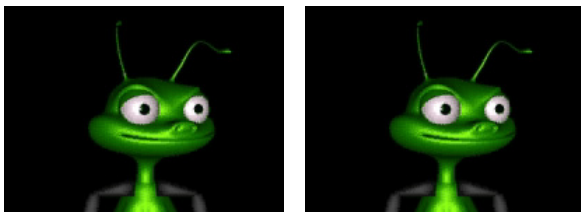
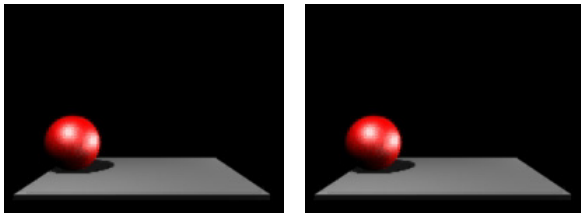

19

Slow in and slow out

An extreme pose can be emphasized by slowing down as you get to it (and as you leave it).

In practice, many things do not move abruptly but start and stop gradually.

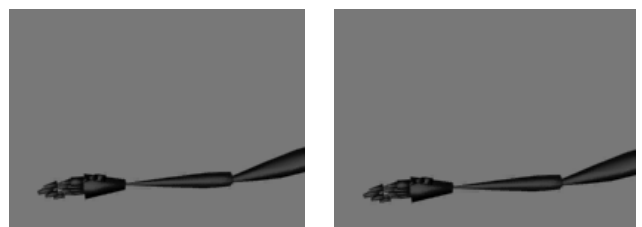
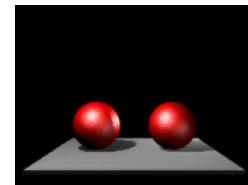

20

Exaggeration

Get to the heart of the idea and emphasize it so the audience can see it.

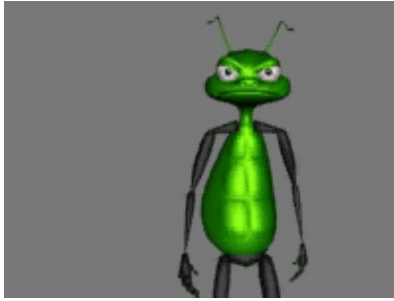

21

Appeal

The character must interest the viewer.

It doesn't have to be cute and cuddly.

Design, simplicity, behavior all affect appeal.

Example: Luxo, Jr. is made to appear childlike.

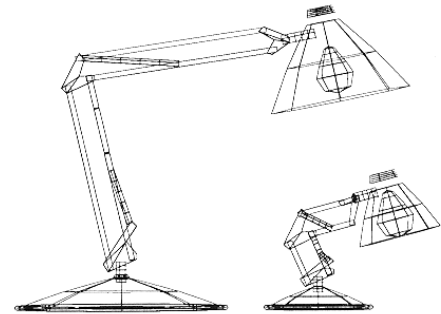
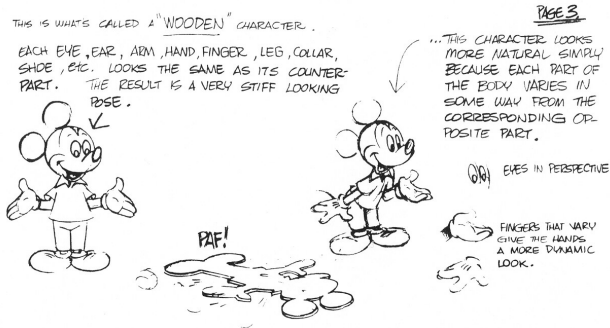

FIGURE 11. Varying the scale of different parts of Dad created the child-like proportions of Luxo Jr.

22

Appeal (cont'd)

Note: avoid perfect symmetries.



23

Appeal (cont'd)

Note: avoid perfect symmetries.



24

Animation artifact

Animation artifact

- ♦ Absolute time limit: **60 seconds**...shorter is usually better. Don't make an animation that feels like "slow motion"!
- ♦ Snapshots due by **12pm Thursday, December 7**
 - Nothing fancy, just something that will help people remember which artifact was yours during voting.
- ♦ Artifacts due by **9am Friday, December 8**

Artifact voting:

- ♦ In-class voting on Friday, December 8
- ♦ Runners-up: mystery prizes
- ♦ 2nd place: Incredibles DVDs
- ♦ 1st place: Cars DVDs + mystery prize