

**CSE 461: Introduction to Computer
Communications Networks
Autumn 2006**

**Module 8
Internet Routing**

**John Zahorjan
zahorjan@cs.washington.edu
534 Allen Center**

This Module

- Distance Vector Routing
- Link State Routing

Application
Presentation
Session
Transport
Network
Data Link
Physical

Kinds of Routing Schemes

- Many routing schemes have been proposed/explored!
- Distributed or centralized
- Hop-by-hop or source-based
- Deterministic or stochastic
- Single or multi-path
- Static or dynamic route selection
- Internet is to the left...

10/9/2006

CSE461 06au

Routing Questions

- How to choose best path?
 - Defining “best” is slippery
- How to scale to millions of users?
 - Minimize control messages and routing table size
- How to adapt to failures or changes?
 - Node and link failures, plus message loss
 - We will use distributed algorithms

10/9/2006

CSE461 06au

Some Pitfalls

- Using global knowledge is challenging
 - Hard to collect
 - Can be out-of-date
 - Needs to summarize in a locally-relevant way
- Inconsistencies in local /global knowledge can cause:
 - Loops (black holes)
 - Oscillations, especially when adapting to load

10/9/2006

CSE461 06au

First Approach: [Distance Vector Routing](#)

- Assume:
 - Each router knows only address of / cost to send to neighbors
- Goal:
 - Calculate routing table of next hop information for each destination at each router
- Idea:
 - Bellman-Ford
 - Tell neighbors about current distances to all destinations
 - Update cost/next hop to each destination based on your neighbors' costs

10/9/2006

CSE461 06au

DV Algorithm

- Each router maintains a vector of costs to *all* destinations, as well as a routing table
 - Initialize neighbors with known cost, others with infinity
- Periodically send distance vector to neighbors
 - On reception of a vector, if neighbor's path to a destination plus cost to neighbor is better, switch to better path
 - update cost in vector and next hop in routing table
- Assuming no changes, will converge to shortest paths
 - But what happens if there are changes?

10/9/2006

CSE461 06au

Distance Vector Example

- Using hop count as the metric

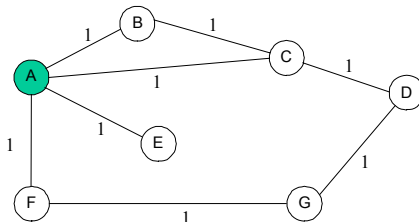

Final Table at A

Dest	Cost	Next
B	1	B
C	1	C
D	2	C
E	1	E
F	1	F
G	2	F

10/9/2006

CSE461 06au

A's Routing Table: Edges on Spanning Trees Rooted at Destinations

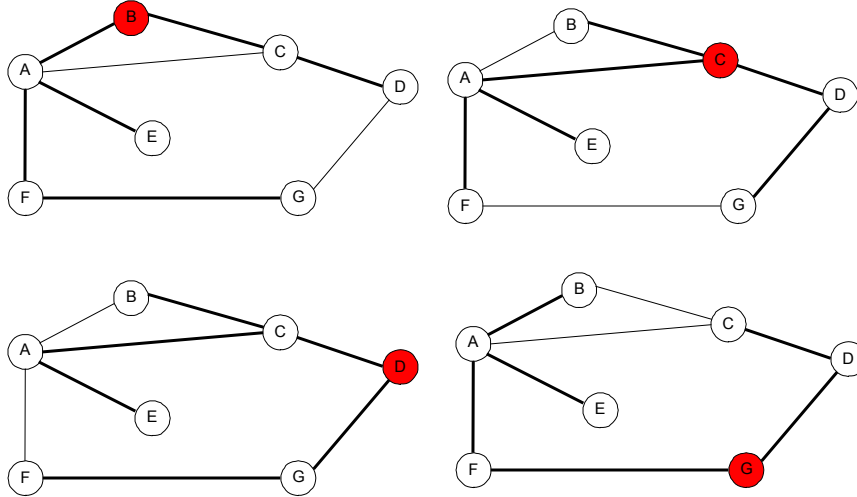

10/9/2006

CSE461 06au

What if there are changes?

- Suppose link between F and G fails
 1. F notices failure, sets its cost to G to infinity
 2. A (eventually) receives costs to G from B (3), C (2), and F (∞) and updates its routing table and cost to use C
 3. F hears cost updated cost from A (3) and adopts A as next hop

Final Table at A

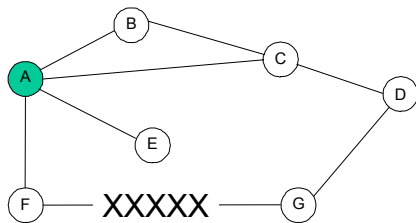

Dest	Cost	Next
B	1	B
C	1	C
D	2	C
E	1	E
F	1	F
G	3	C

10/9/2006

CSE461 06au

Trouble looms

- Now link between D and G fails
 - D notices failure, sets its cost to G to infinity
 - D hears from C that its cost to G is 2, updates to use C
 - C hears cost from A (3), B (3), and D (3), chooses A
 - A updates to B
 - B updates to C

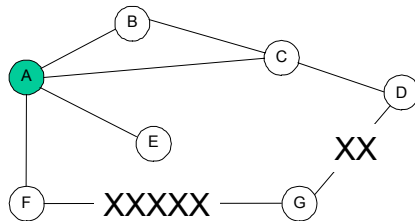

“Count to infinity”
problem

Why does this happen?

10/9/2006

CSE461 06au

Mitigation

- Split Horizon
 - Router never advertises the cost of a destination back to its next hop – that’s where it learned it from!
 - Solves trivial count-to-infinity problem

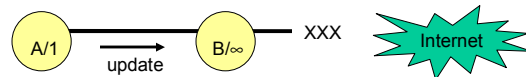

- Poison reverse
 - go even further – advertise infinity back to your next hop
- Hold down
 - If you set cost to infinity, don’t change it until some timer expires

10/9/2006

CSE461 06au

Mitigation (cont.)

- However, DV protocols still subject to the same problem with more complicated topologies
 - Many enhancements suggested
- Make infinity small
 - Reduces time to convergence (to infinity)

10/9/2006

CSE461 06au

RIP: Routing Information Protocol

- DV protocol with hop count as metric
 - Infinity = 16 hops
 - limits size network size
 - Includes split horizon with poison reverse
- Routers send vectors every 30 seconds
 - With triggered updates for link failures
 - Time-out in 180 seconds to detect failures
- RIPv1 specified in RFC1058
 - www.ietf.org/rfc/rfc1058.txt
- RIPv2 (adds authentication etc.) in RFC1388
 - www.ietf.org/rfc/rfc1388.txt

10/9/2006

CSE461 06au

RIP is an “Interior Gateway Protocol”

- Suitable for small- to medium-sized networks
 - such as within a campus, business, or ISP
- Unsuitable for Internet-scale routing
 - hop count metric poor for heterogeneous links
 - 16-hop limit places max diameter on network

Later, we’ll talk about “Exterior Gateway Protocols”
– used between organizations to route across Internet

10/9/2006

CSE461 06au

Second Approach: [Link State Routing](#)

- Same assumptions/goals, but different idea than DV:
 - Each router acquires information on the [full network topology](#) and computes a minimum cost spanning tree with itself as root
 - Why does this work? (How do we know there will be no loops?)
- Two components to implementation:
 1. Topology dissemination
 - Flooding
 2. Shortest-path calculation
 - Dijkstra’s algorithm

10/9/2006

CSE461 06au

Link State: Dijkstra's Algorithm

- Why Dijkstra?
 - Why not?
 - It's fast
 - Link weights are non-negative
- What about behavior under failure?

Final Table at A

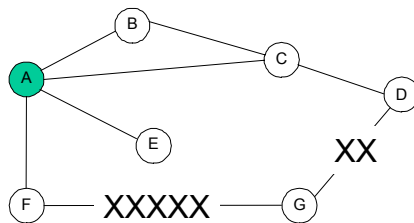

Dest	Cost	Next
B	1	B
C	1	C
D	2	C
E	1	E
F	1	F

10/9/2006

CSE461 06au

Distributing Link State Data: Flooding

- Each router must communicate the state of its outbound links to *all* other routers
 - Each router periodically sends link state packets (LSPs)
 - LSPs contain [router, neighbors, costs]
- Require:
 - New news to travel fast
 - Why?
 - Old news to eventually be forgotten
 - Why?
- Technique: flooding
 - Each router forwards LSPs not already in its database on all ports except where received
 - Each LSP will travel over the same link at most once in each direction
- Flooding is fast, and can be made reliable with ACKs

10/9/2006

CSE461 06au

Example

- LSP generated by X at T=0
- Nodes become yellow as they receive it

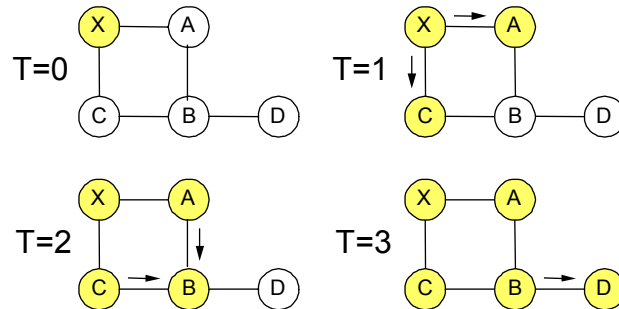

10/9/2006

CSE461 06au

Reliability

- Want LSP to arrive everywhere soon
 - \Rightarrow ARQ
 - \Rightarrow sequence numbers
- What if a router goes down?
 - Its neighbors start advertising cost ∞ to reach it
 - Sequence number check on LSP causes other routers to update their views of the network topology
 - Perfect
- A real-world "glitch"...

10/9/2006

CSE461 06au

ARPANET Failure

- Review: When is one sequence number bigger than another?

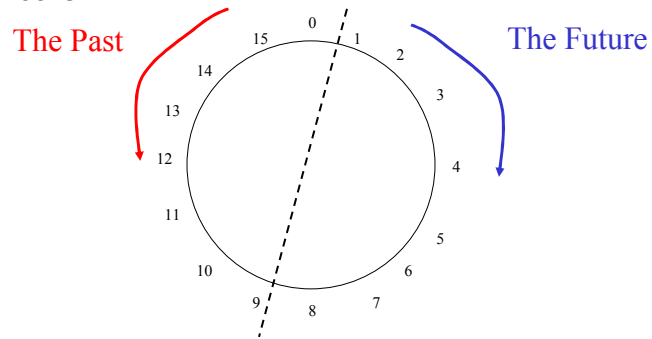

- 6-bit sequence numbers
 - ⇒ 32 sequence numbers to go in the future
 - ⇒ 16 minutes before an old packet "becomes new"
 - ⇒ no problem

10/9/2006

CSE461 06au

ARPANET Failure

- A router went berserk
- Turning off that router doesn't help
 - LSPs circulate forever, updating each other
- Eventually had to inject special code into all other routers to eliminate the bad LSPs

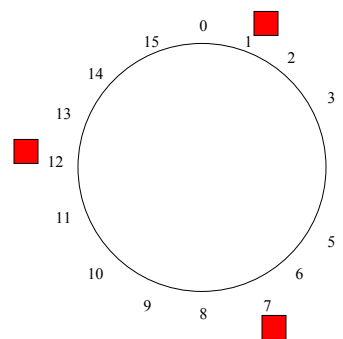

10/9/2006

CSE461 06au

Reaction (OSPF)

- Sequence number field is 32-bits
 - Intended never to wrap
 - 1,361 years to exhaust at 10 seconds/sequence number
- TTL field on LSPs
 - Counts up, one per hop
 - Counts up periodically while in a router's database
 - Thrown away when exceeds some maximum

10/9/2006

CSE461 06au

Open Shortest Path First (OSPF)

- Most widely-used Link State protocol today
- Basic link state algorithms plus many features:
 - Authentication of routing messages
 - Extra hierarchy: partition into routing areas
 - Only bordering routers send link state information to another area
 - Reduces chatter.
 - Border router "summarizes" network costs within an area by making it appear as though it is directly connected to all interior routers
 - Load balancing

10/9/2006

CSE461 06au

Cost Metrics

- How should we choose cost?
 - To get high bandwidth, low delay or low loss?
 - Do they depend on the load?
- Static Metrics
 - Hopcount is easy but treats OC3 (155 Mbps) and T1 (1.5 Mbps)
 - Can tweak result with manually assigned costs
- Dynamic Metrics
 - Depend on load; try to avoid hotspots (congestion)
 - But can lead to oscillations (damping needed)

10/9/2006

CSE461 06au

Revised ARPANET Cost Metric

- Based on load and link
- Variation limited (3:1) and change damped
- Capacity dominates at low load; we only try to move traffic if high load

9.6-Kbps satellite link	-----
9.6-Kbps terrestrial link	- - - - -
56-Kbps satellite link	_____
56-Kbps terrestrial link	_____

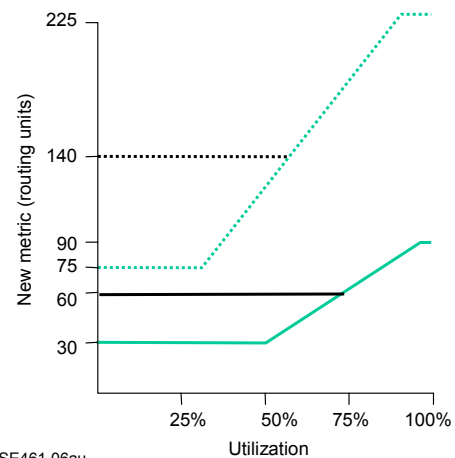

10/9/2006

CSE461 06au

Key Concepts

- Routing uses global knowledge; forwarding is local
- Many different algorithms address the routing problem
 - We have looked at two classes: DV (RIP) and LS (OSPF)
- Challenges:
 - Handling failures/changes
 - Defining “best” paths
 - Scaling to millions of users