

CSE 461: Computer Networks

Spring 2021

Ratul Mahajan

Milin Kodnongbua, Pat Kosakanchit,
Nicolas Moneses, Nathan White, Michael Wiem

Who we are

Ratul

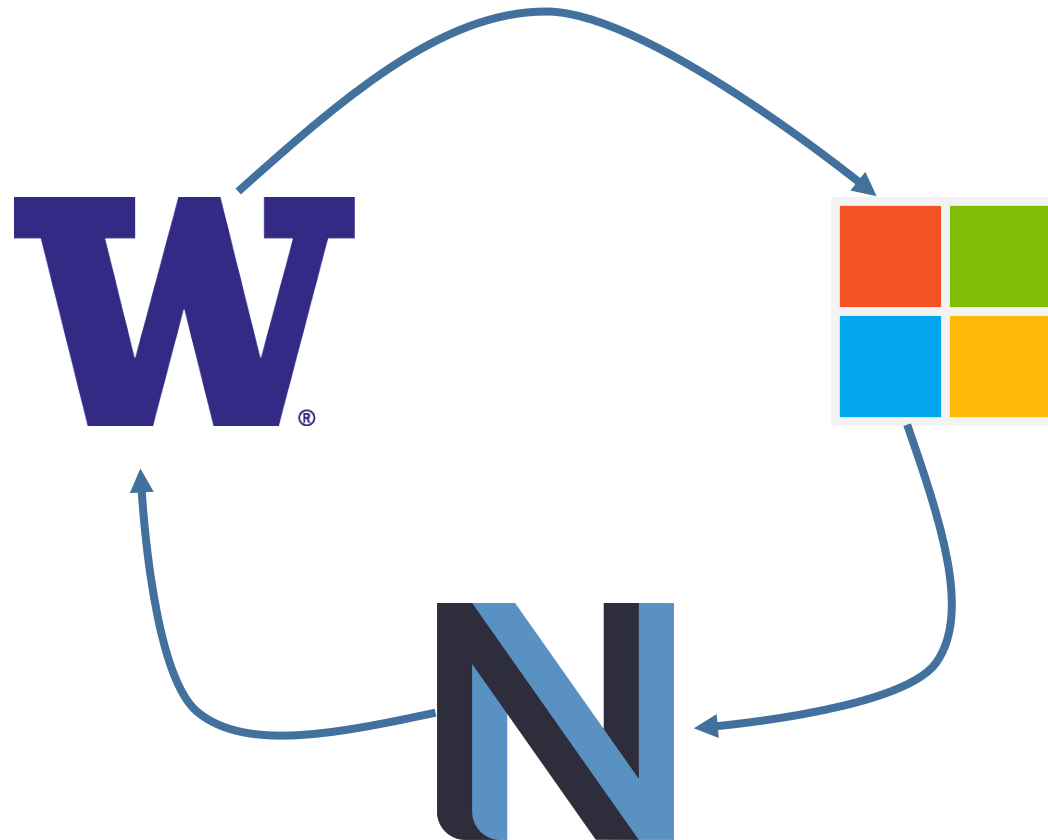

Milin Kodnongbua

- Hometown: Thailand
- Year: Undergraduate Junior, Graduating June 2022
- Some fun facts:
 - Minor in Economics
 - Likes binge-watching KDrama
 - Still plays Vainglory



Pat Kosakanchit

- Hometown: Bangkok, Thailand
- Year: BS/MS, graduating December 2021
- Some fun facts about me:
 - Doing research at ICTD lab
 - Loves board games
 - Loves street photography
 - I go to Sisi Kay in Wallingford for authentic Pad Thai
 - Just starts learning aerial hammock



Nick Monsees

- Hometown: Orange, California
- Year: BS/MS, graduating June 2021
- Some fun facts:
 - Member of UW's rocket club (SARP)
 - Has caused a (minor) explosion on campus
 - Cares too much about the NFL Draft
 - Still believes in Blackberry stock



Nathan White

- Hometown: Los Angeles, California
- Year: Senior
 - B.S. Computer Science
 - Minor in Entrepreneurship
- Internships at Amazon
- Fun facts
 - I compete in security competitions like CCDC
 - I like hiking and biking
 - I also enjoy photography/video production
 - I play way too much Overwatch



Michael Wiem

- Hometown: Jakarta, Indonesia
- Year: Senior, final quarter!
- Facts, that are fun:
 - SEAL member
 - FIUTS Student Board Member
 - Somehow bad at all sports known to humankind
 - I once met Andy Jassy
 - Prefer ethernet than wifi



Class Structure

Grading

Assignments: 10%

- Reading and homework from the book

Grading

Assignments: 10%

Surprise Quizzes: 5%

- Short quizzes during the quarter
- Drop lowest

Grading

Assignments: 10%

Surprise Quizzes: 10%

3 Projects: (15 + 15 + 15)%

- 3 coding exercises:
 - Socket programming
 - Link and Network layer behavior
 - Buffer bloat

Grading

Assignments: 10%

Surprise Quizzes: 5%

3 Projects: (15 + 15 + 15)%

Midterm: 15%

Final: 20%

Participation: 5%

Grading

Assignments: 10%

Surprise Quizzes: 5%

3 Projects: (15 + 15 + 15)%

Midterm: 15%

Final: 20%

Participation: 5%

Late Policy:

- 10% penalty for each late day
- Each **person** gets three late days

Administrivia

- Office hours
 - Opportunity to have more personal interactions with course staff.
- Tools
 - Canvas: Assignments, quizzes, and projects
 - ed discussion: Back and forth discussions on class content, announcements
 - Canvas Gradebook: Grades will be posted here
- Slides
 - Adapted from Kurtis Heimerl, who adapted from David Wetherall
 - I will be posting my own slides online

Questions?

CSE 461: Computer Networks

Focus of the course

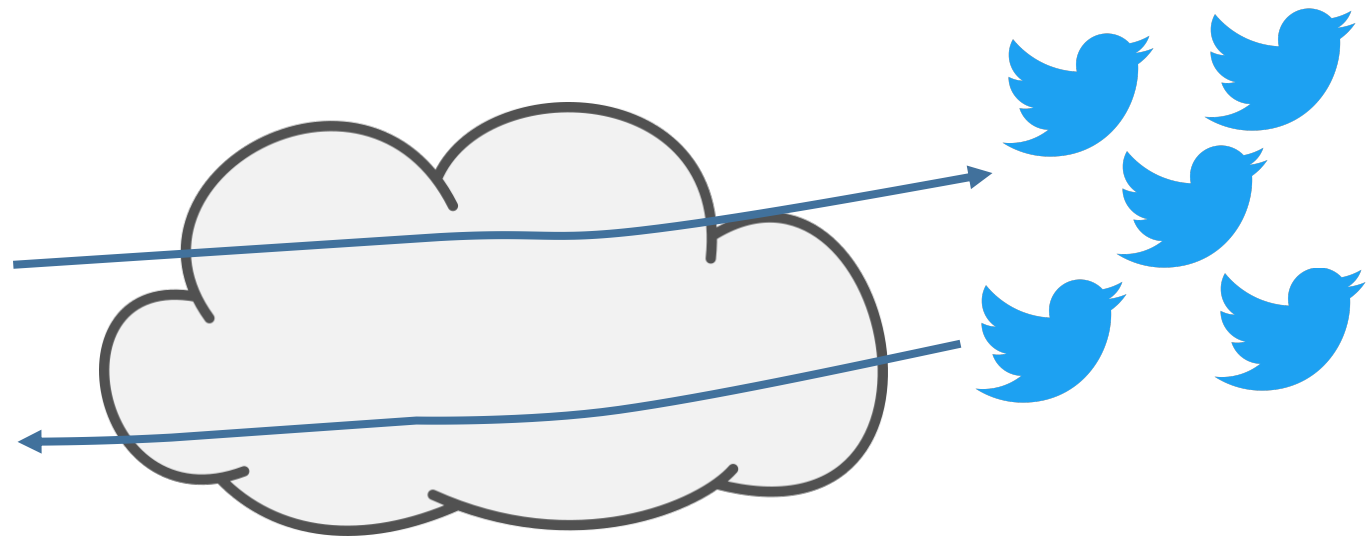

Focus of the course (2)

Three “networking” topics:

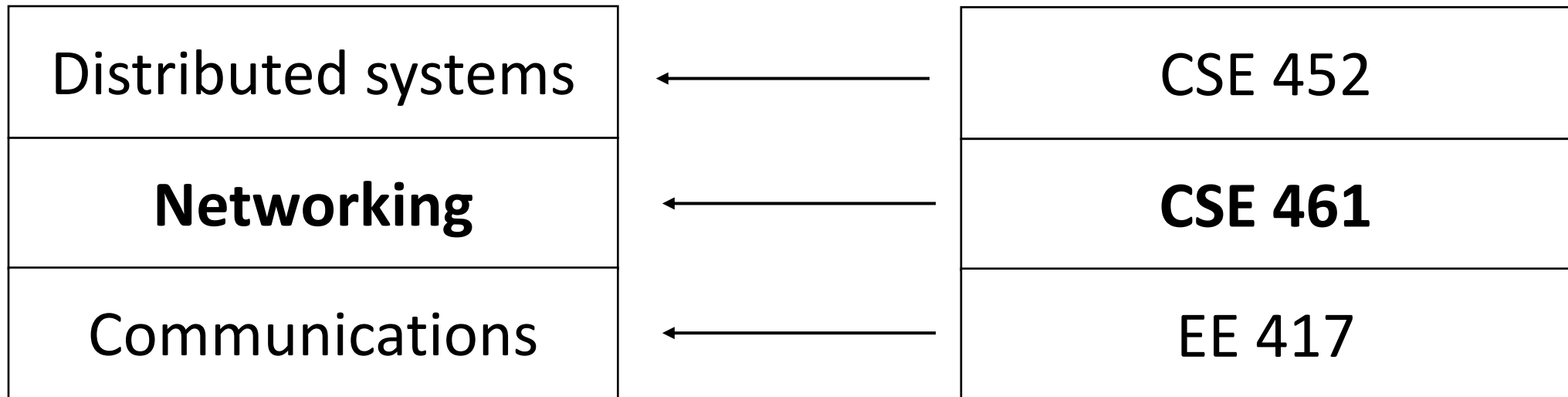

Main goals

1. Learn the fundamentals of computer networks
- 2. Learn how the Internet works**
 - What really happens when you “browse the web”?
 - TCP/IP, DNS, HTTP, NAT, VPNs, 802.11 etc.
3. Understand how and why of Internet design
 - SDN, Load Balancers, Architectures

Why learn the fundamentals?

Intellectual interest

Reinvention, broad applicability

- Non-Internet networks
- Changing Internet

Fundamentals - Reliable communication

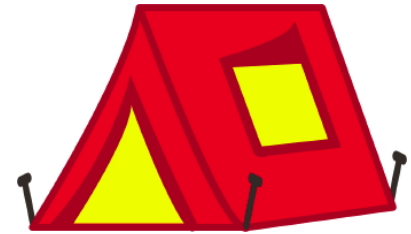
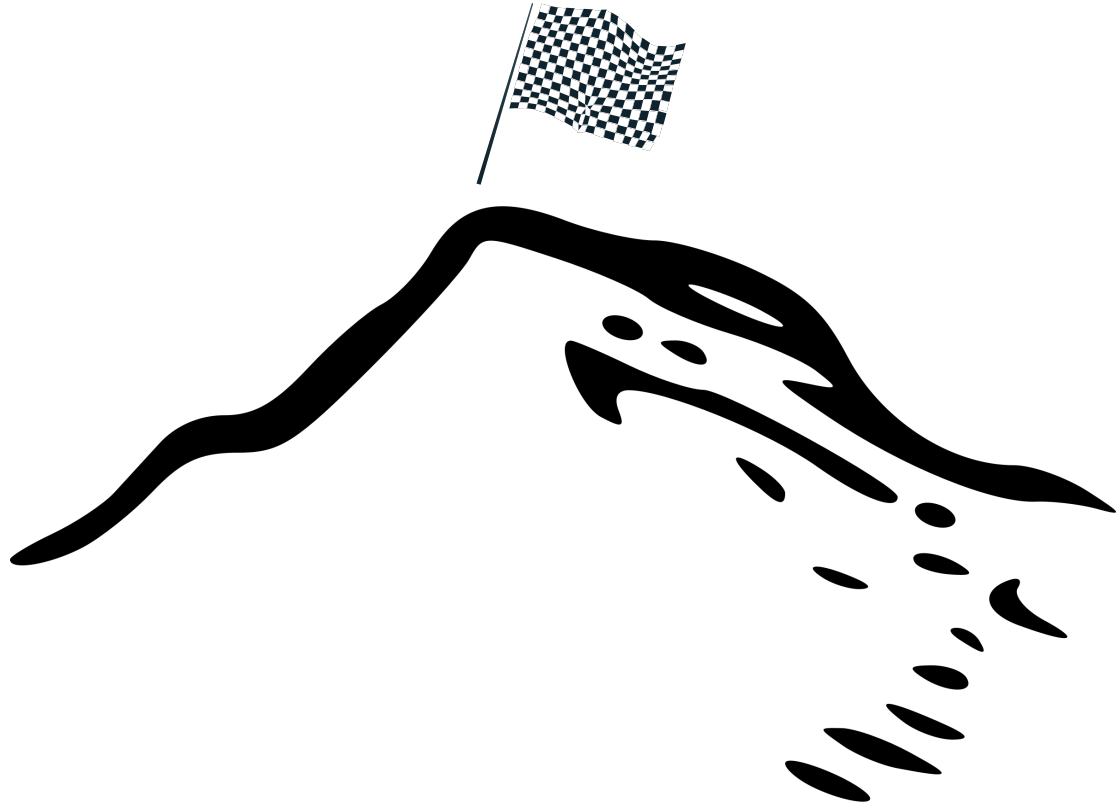
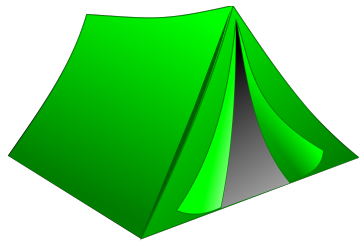

Fundamentals – Channel throughput



1 Gbps

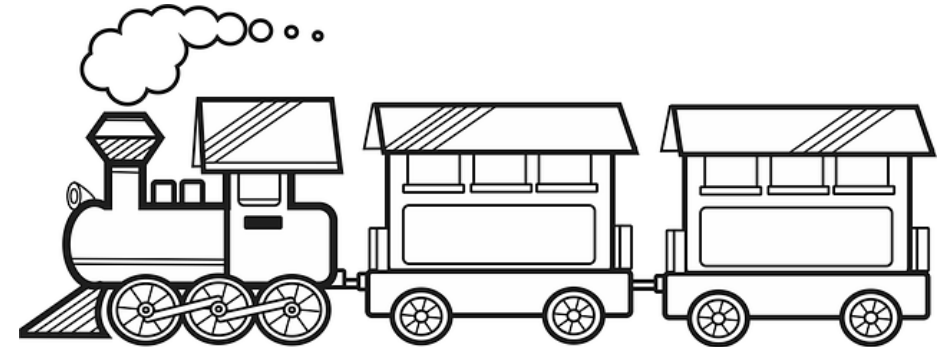

20ft container = 2,350,080 in³ (240 x 96 x 102)
3.5in SSD = 23 in³ (4 x 5.75 x 1)
SSDs / container = 50K (50% packing efficiency)
Container capacity = 25PB (512 GB per SSD)
Container speed = 100 mph
SEA <> NYC throughput = ~2000 Gbps

Fundamentals – Reinvention

- The Internet is constantly being re-invented!
 - Growth over time and technology trends drive upheavals in Internet design
- Today's Internet is different from yesterday's
 - And tomorrow's will be different again
 - But the fundamentals remain the same

Internet growth

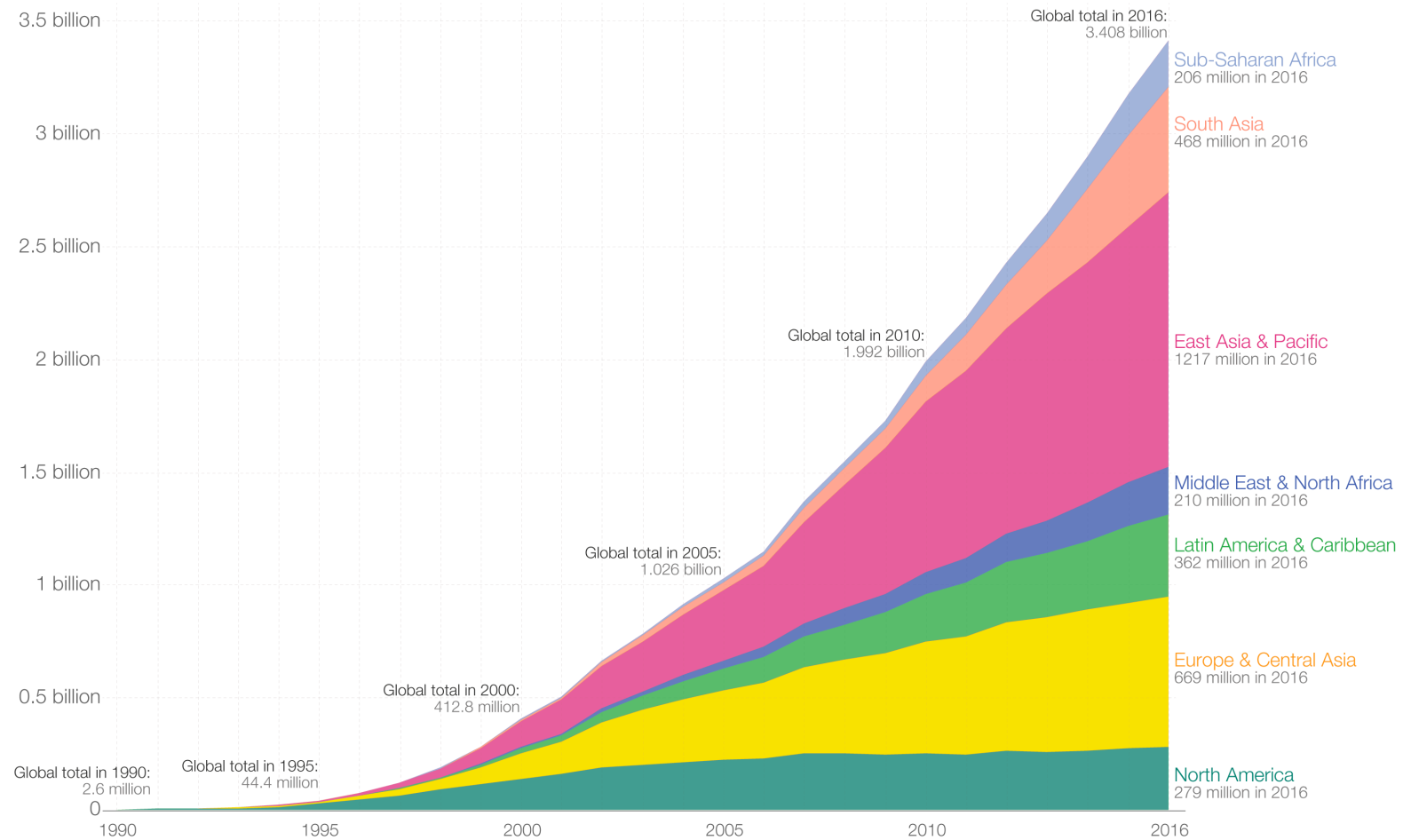

Data source: Based on data from the World Bank and data from the International Telecommunications Union. Internet users are people with access to the worldwide network. The interactive data visualization is available at OurWorldinData.org. There you find the raw data and more visualizations on this topic. Licensed under [CC-BY-SA](https://creativecommons.org/licenses/by-sa/4.0/) by the author Max Roser.

Example upheavals

Change	Enabling Technology
Emergence of Web	Content Distribution Networks
Piracy	Peer-to-peer file sharing
Internet of Things	IPv6
Mobile Devices	Wireless, High bandwidth cellular
Cloud computing	Virtualization
Crypto currencies	Blockchains
....

Main goals

1. To learn the fundamentals of computer networks
- 2. Learn how the Internet works**
 - What really happens when you “browse the web”?
 - TCP/IP, DNS, HTTP, NAT, VPNs, 802.11 etc.
3. Understand how and why of Internet design
 - SDN, Load Balancers, Architectures

Who cares about the internet?

1. Curiosity
2. Impact on our world
3. Job prospects!

From this experimental network (~1970)...

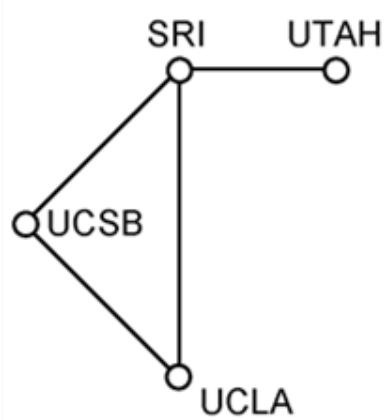

(a) Dec. 1969.

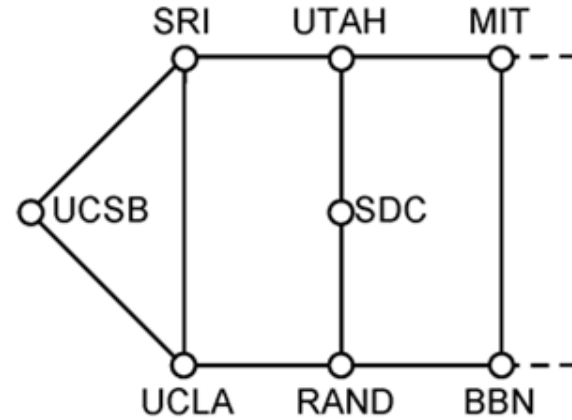

(b) July 1970.

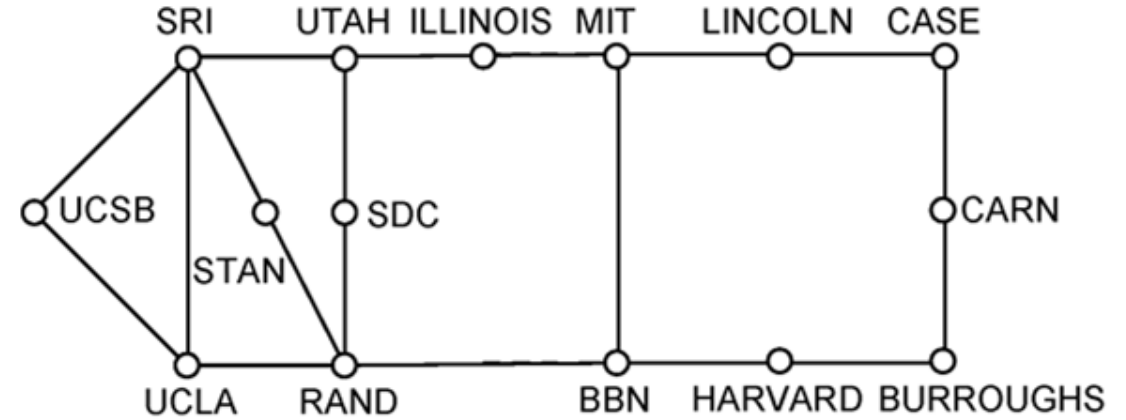

(c) March 1971.

ARPANET LOGICAL MAP, MARCH 1977

To this...

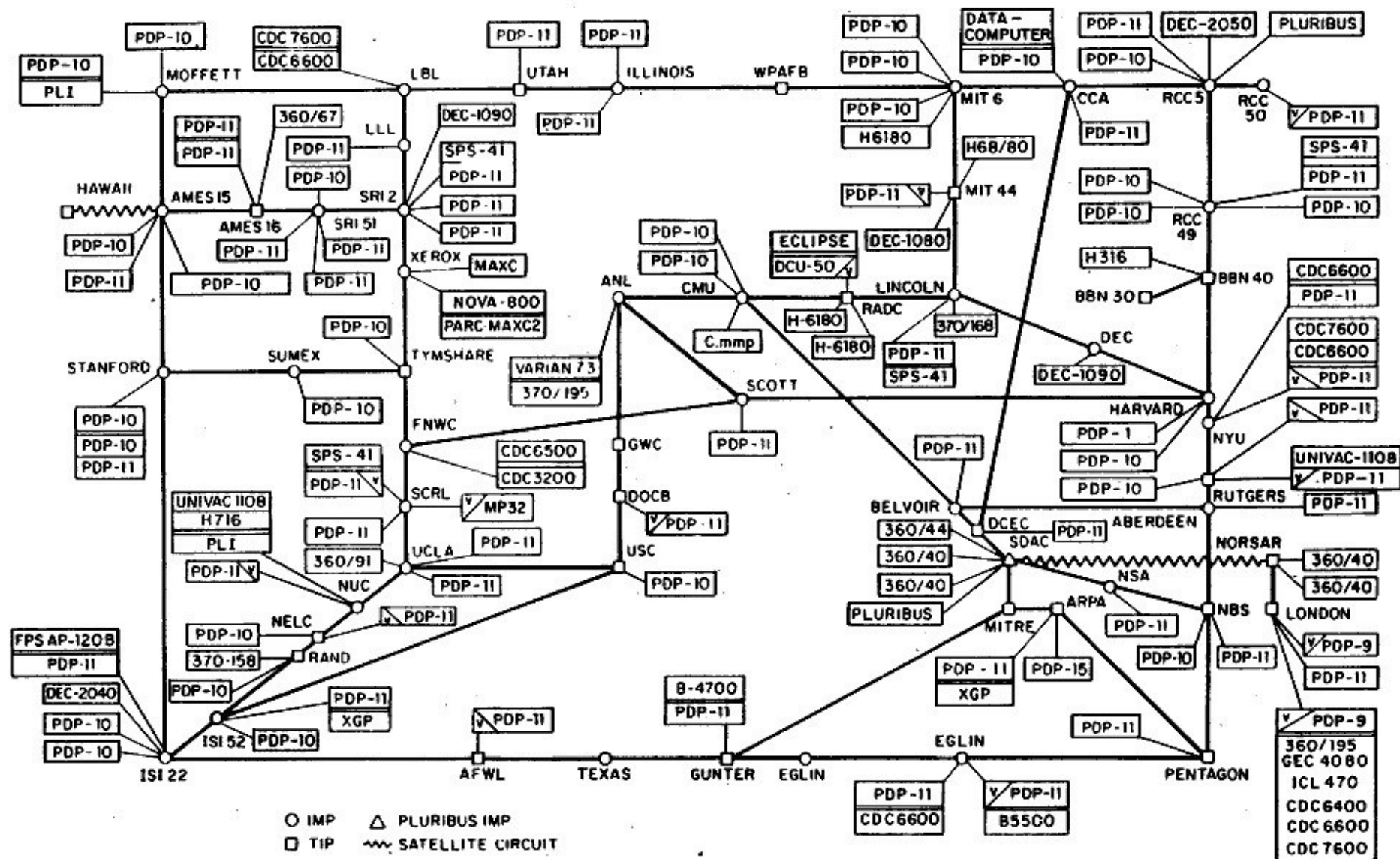

(PLEASE NOTE THAT WHILE THIS MAP SHOWS THE HOST POPULATION OF THE NETWORK ACCORDING TO THE BEST INFORMATION OBTAINABLE, NO CLAIM CAN BE MADE FOR ITS ACCURACY)

NAMES SHOWN ARE IMP NAMES, NOT (NECESSARILY) HOST NAMES

To this! (2011)

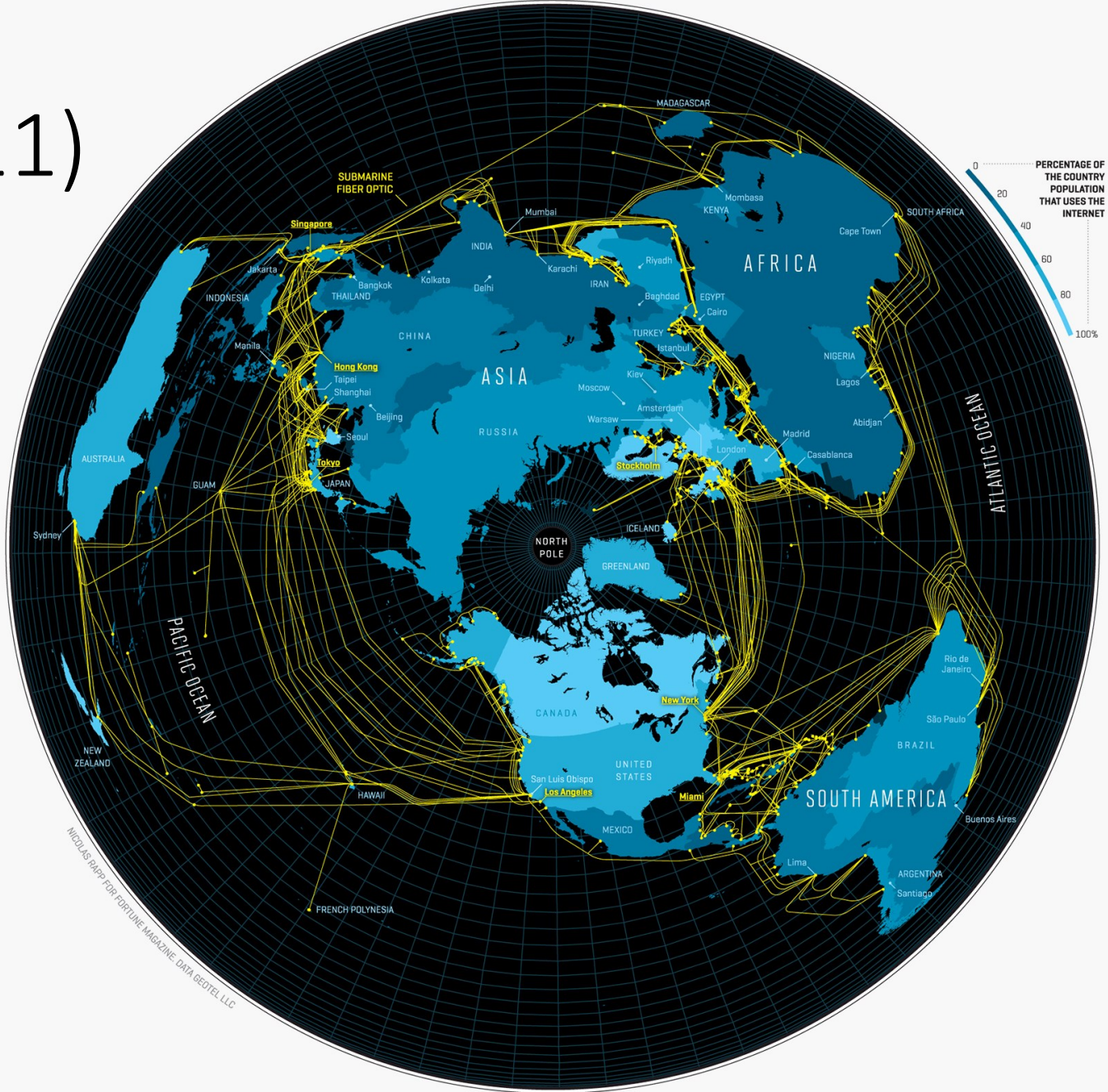

And this (2015)!

- An everyday institution used at work, home, and on-the-go
- Visualization contains millions of servers
 - Red = .com, Yellow= .org
- Network now contains literally 3 billion **people!**

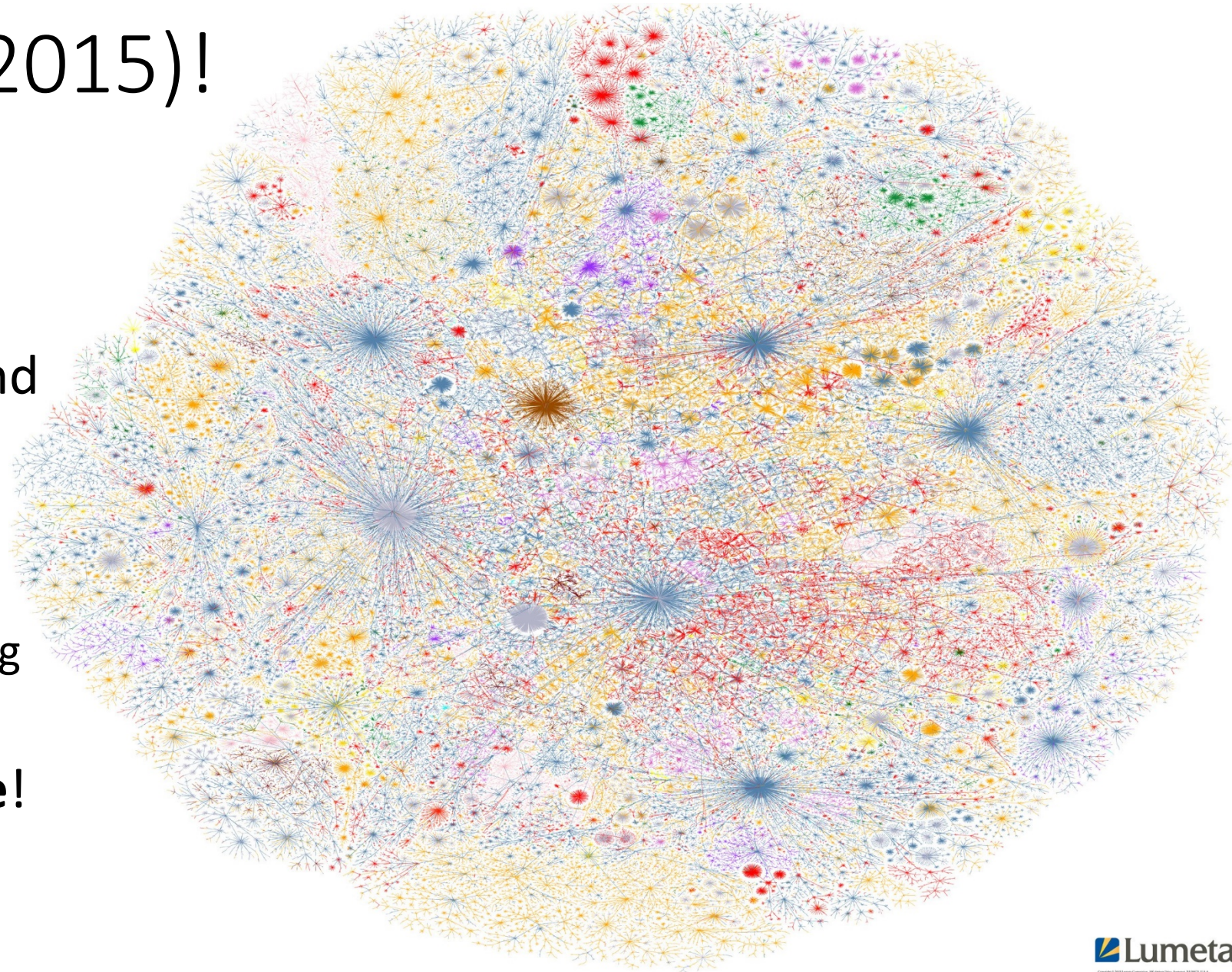

Internet – Societal Impact

- An enabler of societal change
 - Easy access to knowledge
 - Electronic commerce
 - Personal relationships
 - Private communications



WIKIPEDIA



Internet – Economic impact

- An engine of economic growth
 - Information sources
 - And lots of ethical questions!
 - Online marketplaces
 - Social media/Crowdsourcing

The Google logo, featuring the word "Google" in its characteristic multi-colored font (blue, red, yellow, blue, green, red).The Facebook logo, consisting of the word "facebook" in white lowercase letters on a dark blue rectangular background.The eBay logo, featuring the word "eBay" in a stylized font with each letter in a different color (e: red, b: blue, a: yellow, y: green).The Craigslist logo, featuring the word "craigslist" in a purple, lowercase, serif font.

Main goals

1. To learn the fundamentals of computer networks
2. Learn how the Internet works
 - What really happens when you “browse the web”?
 - TCP/IP, DNS, HTTP, NAT, VPNs, 802.11 etc.
3. Understand how and why of Internet design
 - SDN, Load Balancers, Architectures

Architectures

Lots of ways to build networks with different **tradeoffs**

- Internet -- open access
 - Flexibility++, Privacy++, Security--
- Cellular -- identity first
 - Flexibility--, Privacy --, Security++,



Not a Course Goal

To learn IT job skills

- How to configure specific equipment or technologies
 - e.g., Cisco certifications,
 - Technical whack-a-mole
- But course material is relevant, and we use hands-on tools
 - Hopefully you'll be able to use these tools to build stuff at the end of class

Main goals

1. To learn the fundamentals of computer networks
2. Learn how the Internet works
 - What really happens when you “browse the web”?
 - TCP/IP, DNS, HTTP, NAT, VPNs, 802.11 etc.
3. Understand how and why of Internet design
 - SDN, Load Balancers, Architectures

Questions?