

# IPv6

# IP Version 6 to the Rescue

- Effort started by the IETF in 1994
  - Much larger addresses (128 bits)
  - Many sundry improvements
- Became an IETF standard in 1998
  - Nothing much happened for a decade
  - Hampered by deployment issues, and a lack of adoption incentives
  - Big push ~2011 as exhaustion looms

# IPv6

- Features large addresses
  - 128 bits, most of header
- New notation
  - 8 groups of 4 hex digits (16 bits)
  - Omit leading zeros, groups of zeros

Ex: 2001:0db8:0000:0000:0000:ff00:0042:8329  
→ 2001:db8::ff00:42:8329

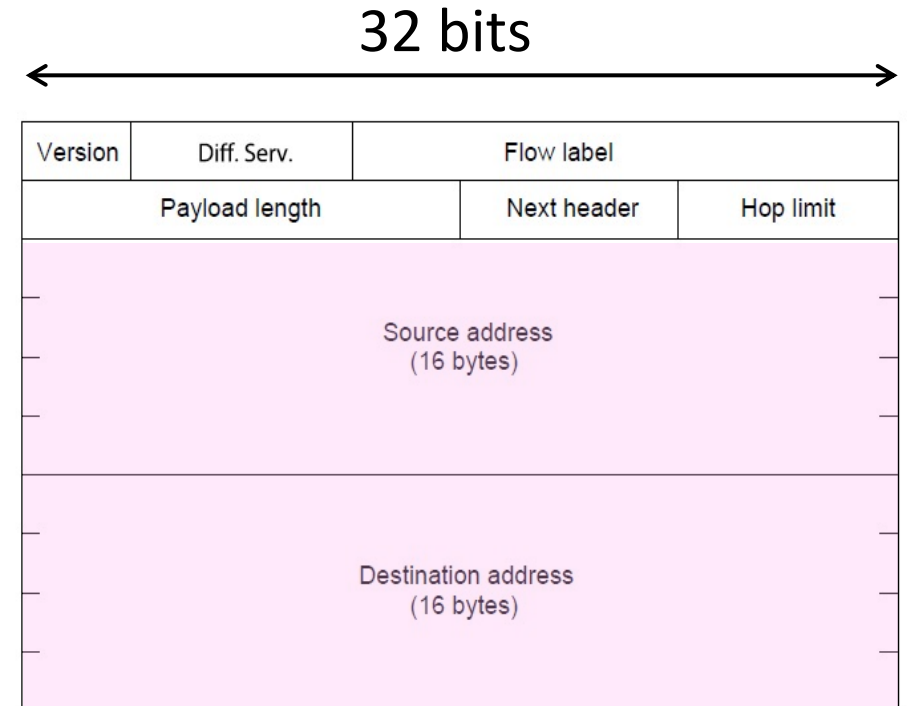

# IPv6 (2)

- Lots of other changes
  - Only public addresses
    - No more NAT!
  - Streamlined header processing
    - No checksum (why's that faster?)
  - Flow label to group of packets
  - IPSec by default
  - Better fit with “advanced” features (mobility, multicasting, security)

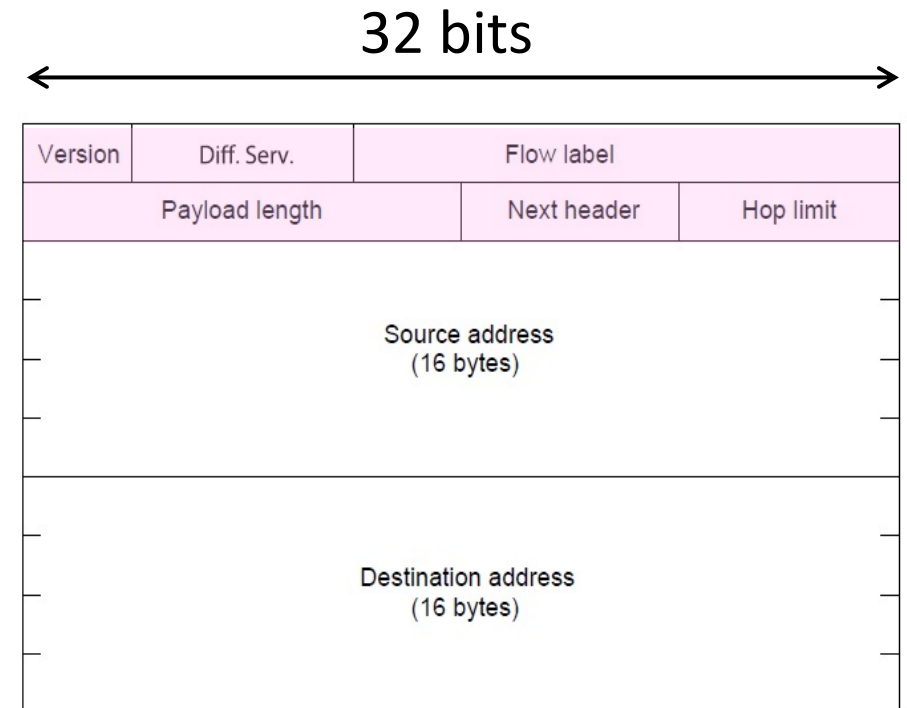

# IPv6 Stateless Autoconfiguration (SLAAC)

- Replaces DHCP (sorta...)
- Uses ICMPv6
- Process:
  - Send broadcast message
  - Get prefix from router
  - Attach MAC to router Prefix

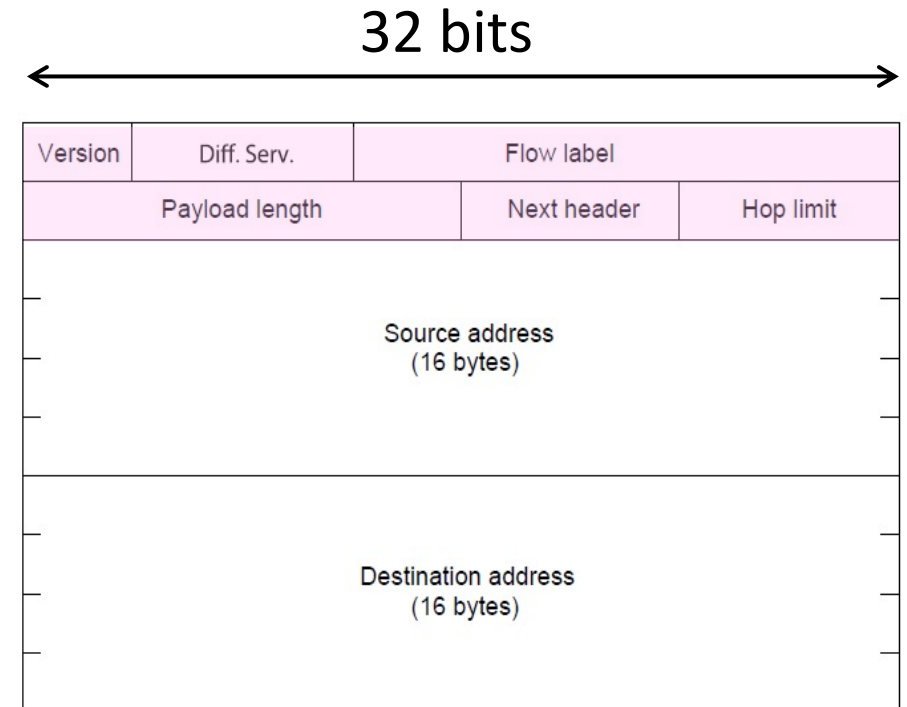

# IPv6 Transition

- The Big Problem:
  - How to deploy IPv6?
  - Fundamentally incompatible with IPv4
- Dozens of approaches proposed
  - Dual stack (speak IPv4 and IPv6)
  - Translators (convert packets)
  - Tunnels (carry IPv6 over IPv4)

# Tunneling

- Native IPv6 islands connected via IPv4
  - Tunnel carries IPv6 packets across IPv4 network

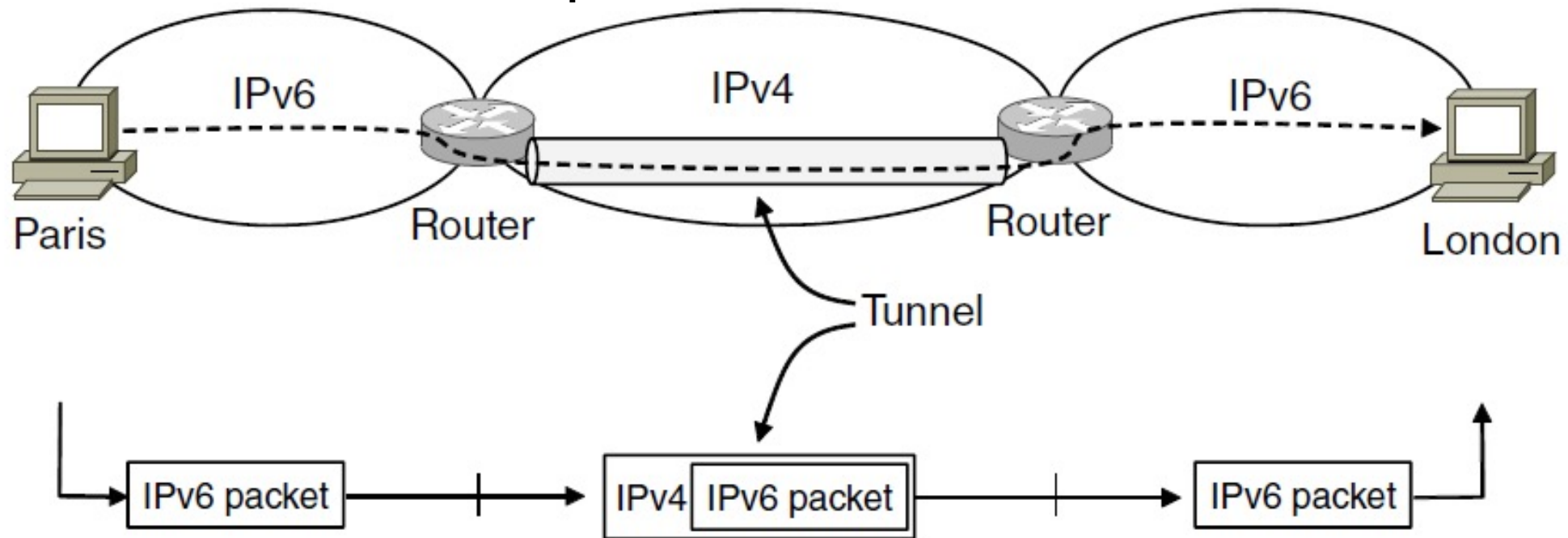

# Tunneling (2)

- Tunnel acts as a single link across IPv4 network

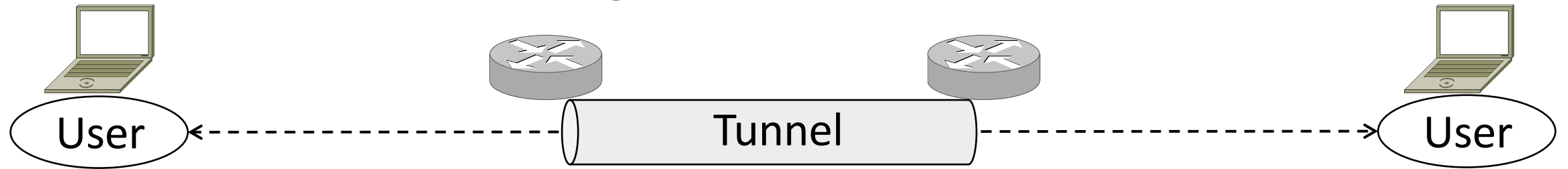



# Tunneling (3)

- Tunnel acts as a single link across IPv4 network
  - Difficulty is to set up tunnel endpoints and routing

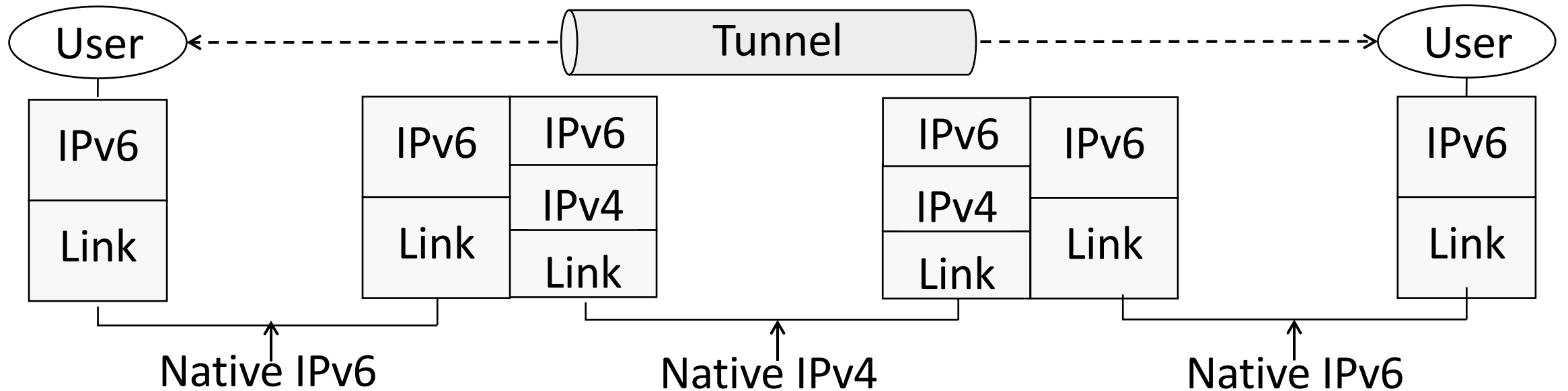

# Routing and forwarding

# Recap: Routing versus Forwarding

- Forwarding is the process of sending a packet on its way

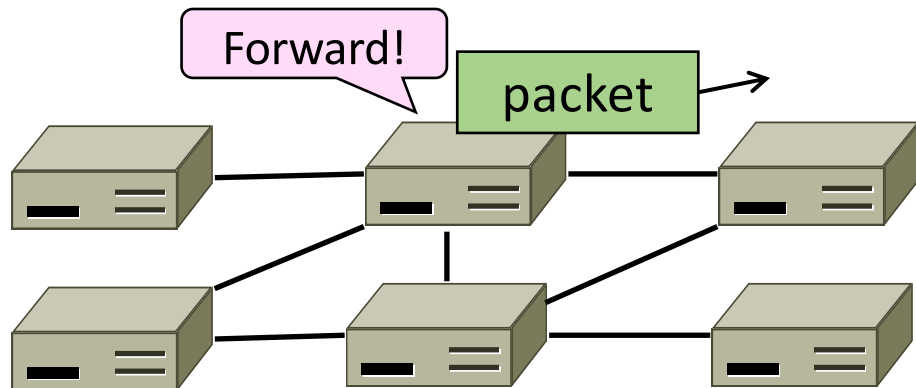

- Routing is the process of deciding in which direction to send traffic

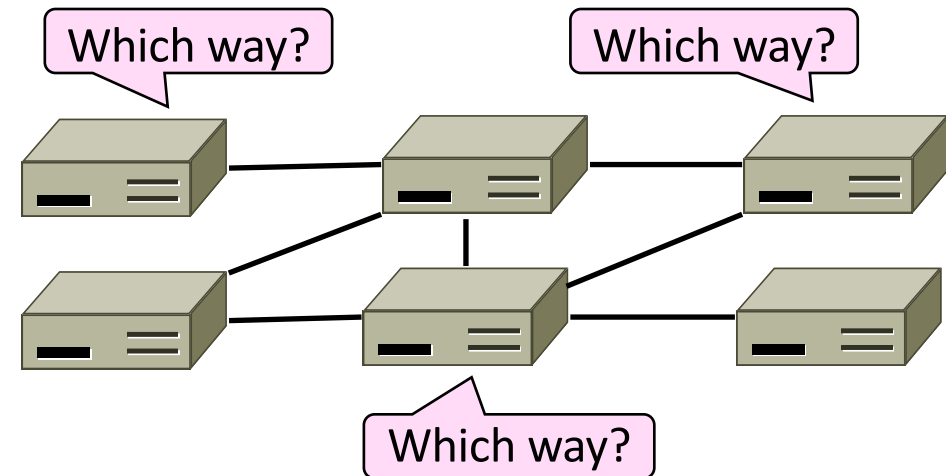

# Overview of Internet Routing and Forwarding

- Hosts on same network have IPs in the same IP prefix
- Hosts send off-network traffic to the gateway router
- Routers discover routes to different prefixes (routing)
- Routers use longest prefix matching to send packets to the right next hop (forwarding)

# Longest Prefix Matching

- Prefixes in the forwarding table can overlap

Prefix	Next Hop
0.0.0.0/0	A
192.24.0.0/19	B
192.24.12.0/22	C

- Longest prefix matching forwarding rule:
  - For each packet, find the longest prefix that contains the destination address, i.e., the most specific entry
  - Forward the packet to the next hop router for that prefix

# Longest Prefix Matching (2)

Prefix	Next Hop
192.24.0.0/19	D
192.24.12.0/22	B

192.24.6.0 → ?

192.24.14.32 → ?

192.24.54.0 → ?

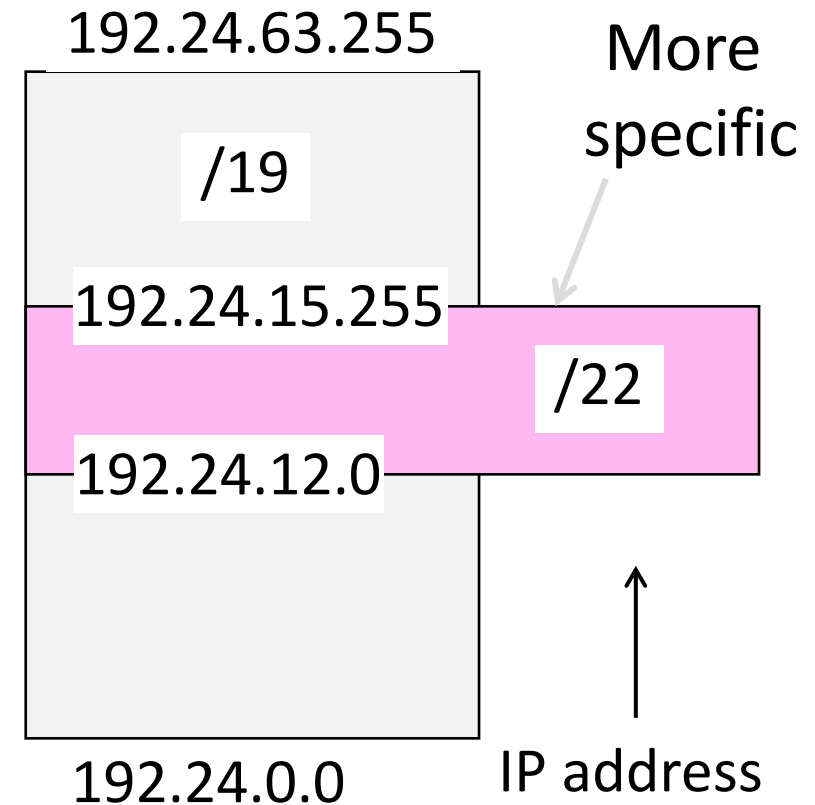

# Flexibility of Longest Prefix Matching

- Can provide default behavior, with less specifics
  - Send traffic going outside an organization to a border router (gateway)
- Can special case behavior, with more specifics
  - For performance, economics, security, ...

# Performance of Longest Prefix Matching

- Uses hierarchy for a compact table
  - Relies on use of large prefixes
- Lookup more complex than table
  - Used to be a concern for fast routers
  - Not an issue in practice these days



# Goals of Routing Algorithms

- We want several properties of any routing scheme:

Property	Meaning
Correctness	Finds paths that work
Efficient paths	Uses network bandwidth well
Fair paths	Doesn't starve any nodes
Fast convergence	Recovers quickly after changes
Scalability	Works well as network grows large

# Rules of Fully Distributed Routing

- All nodes are alike; no controller
- Nodes learn by exchanging messages with neighbors
- Nodes operate concurrently
- There may be node/link/message failures

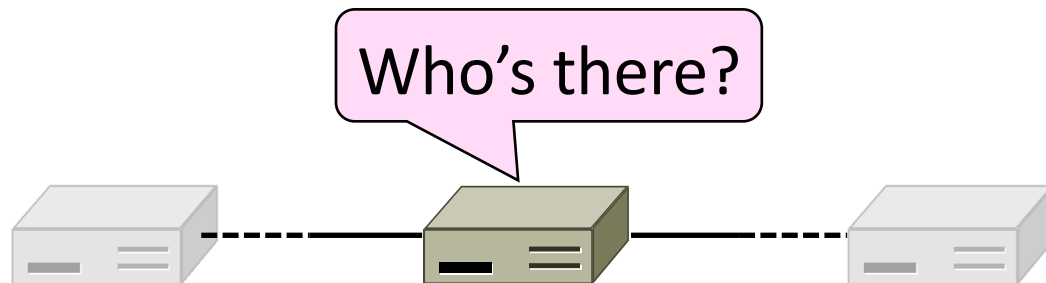

# Simple routing that obeys the rules

- Send out routes for hosts you have paths to
  - And the routes they've sent you

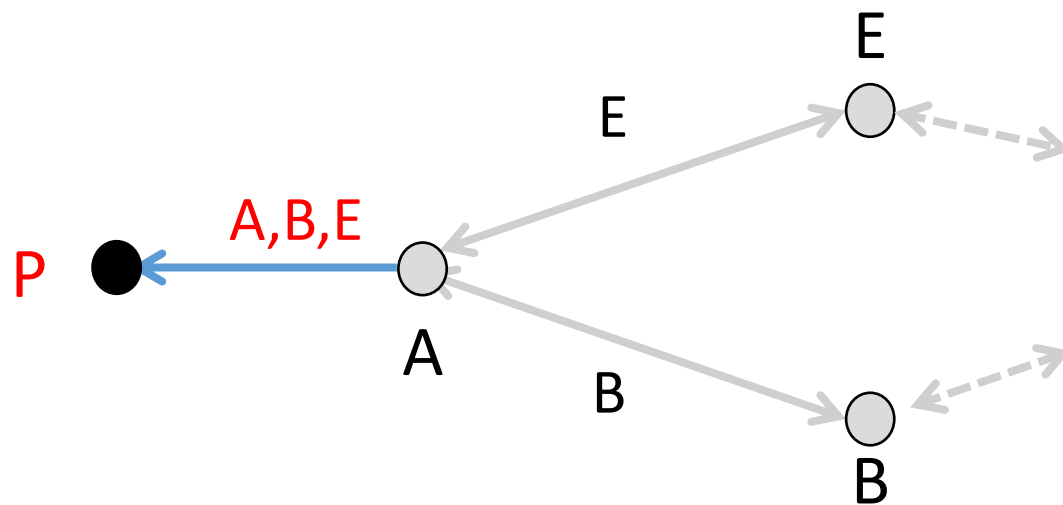

- This works
  - All routers find a path to all hosts
- But scales poorly!

# Recall: Internet Size

- Over 4 billion people
- 50B devices connect

# Impact of Network Growth

## 1. Forwarding tables grow

- Larger router memories, may increase lookup time

## 2. Routing messages grow

- Need to keep all nodes informed of larger topology

## 3. Routing computation grows

- Shortest path calculations grow faster than the network

# Techniques to Scale Routing

- **First: Network hierarchy**
  - Route to network regions
- **Next: IP prefix aggregation**
  - Combine, and split, prefixes

Scaling Idea 1:  
Hierarchical Routing

# Idea

- Scale routing using hierarchy with regions
  - Route to regions, not individual nodes

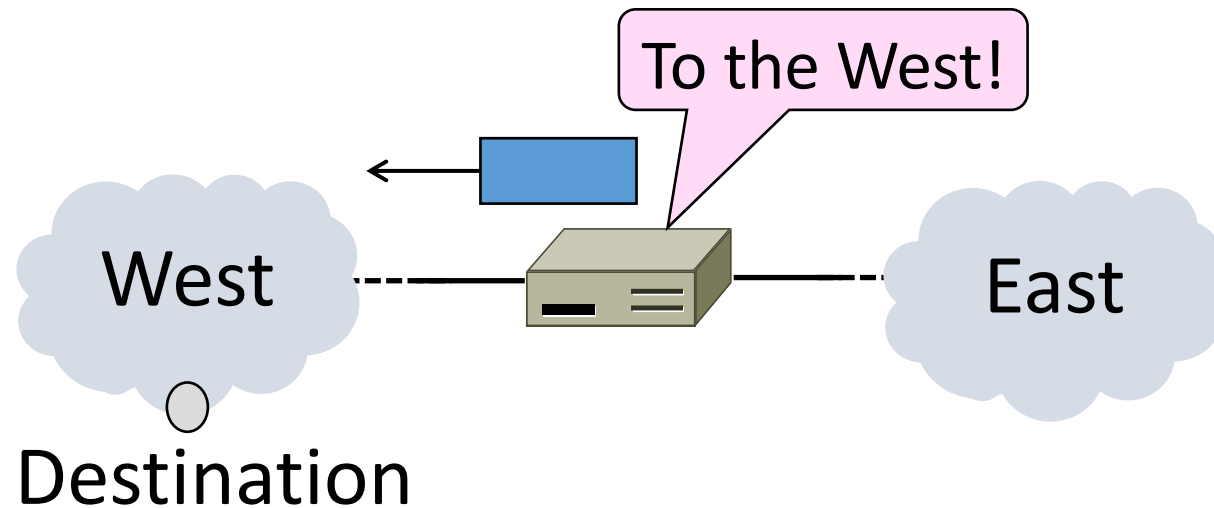



# Hierarchical Routing

- Introduce a larger routing unit
  - IP prefix (hosts) ← from one host
  - Region, e.g., ISP network
- Route first to the region, then to the IP prefix within the region
  - Hide details within a region from outside of the region

# Hierarchical Routing (2)

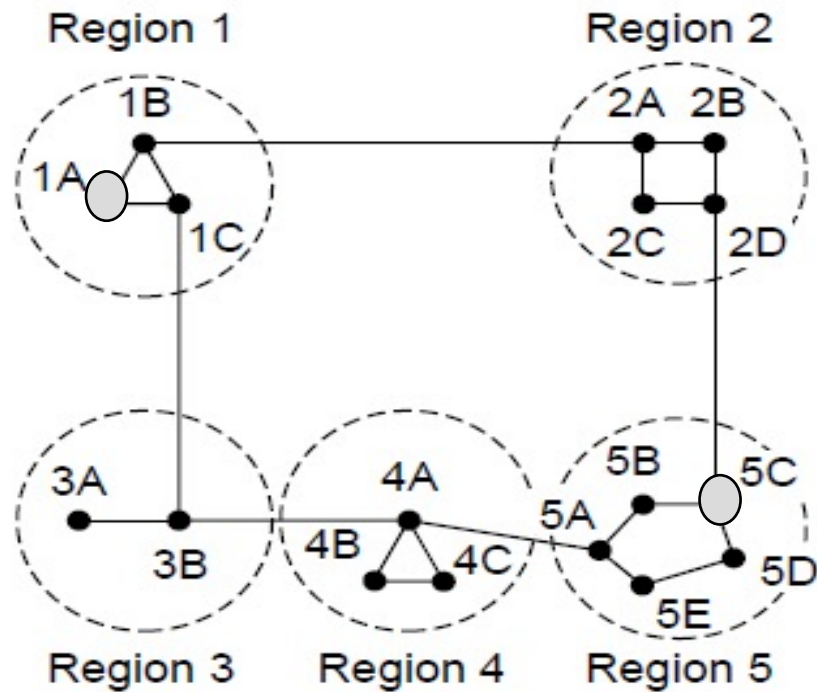

Full table for 1A

Dest.	Line	Hops
1A	-	-
1B	1B	1
1C	1C	1
2A	1B	2
2B	1B	3
2C	1B	3
2D	1B	4
3A	1C	3
3B	1C	2
4A	1C	3
4B	1C	4
4C	1C	4
5A	1C	4
5B	1C	5
5C	1B	5
5D	1C	6
5E	1C	5

Hierarchical table for 1A

Dest.	Line	Hops
1A	-	-
1B	1B	1
1C	1C	1
2	1B	2
3	1C	2
4	1C	3
5	1C	4

# Hierarchical Routing (3)

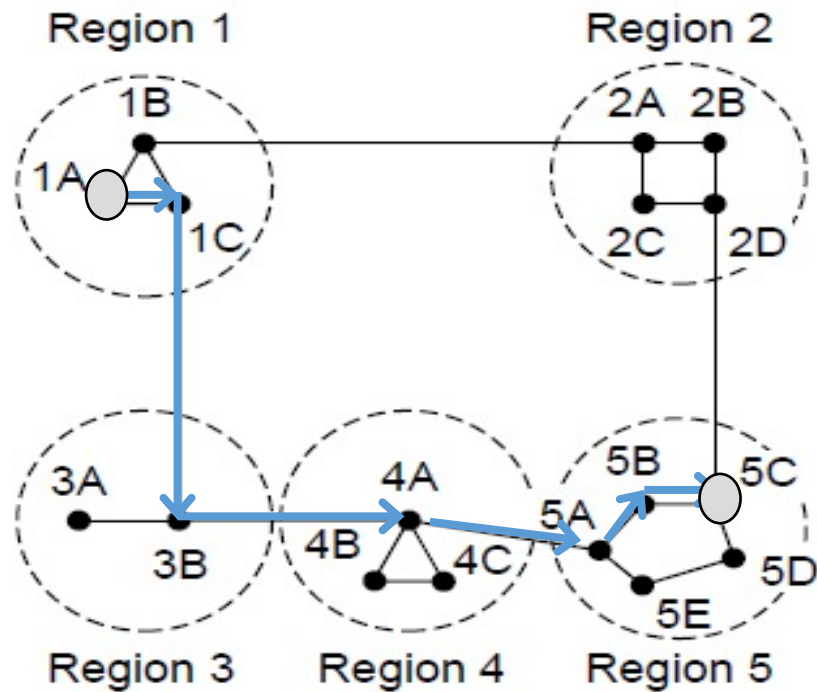

Full table for 1A

Dest.	Line	Hops
1A	-	-
1B	1B	1
1C	1C	1
2A	1B	2
2B	1B	3
2C	1B	3
2D	1B	4
3A	1C	3
3B	1C	2
4A	1C	3
4B	1C	4
4C	1C	4
5A	1C	4
5B	1C	5
5C	1B	5
5D	1C	6
5E	1C	5

Hierarchical table for 1A

Dest.	Line	Hops
1A	-	-
1B	1B	1
1C	1C	1
2	1B	2
3	1C	2
4	1C	3
5	1C	4

# Hierarchical Routing (4)

- Penalty is longer paths

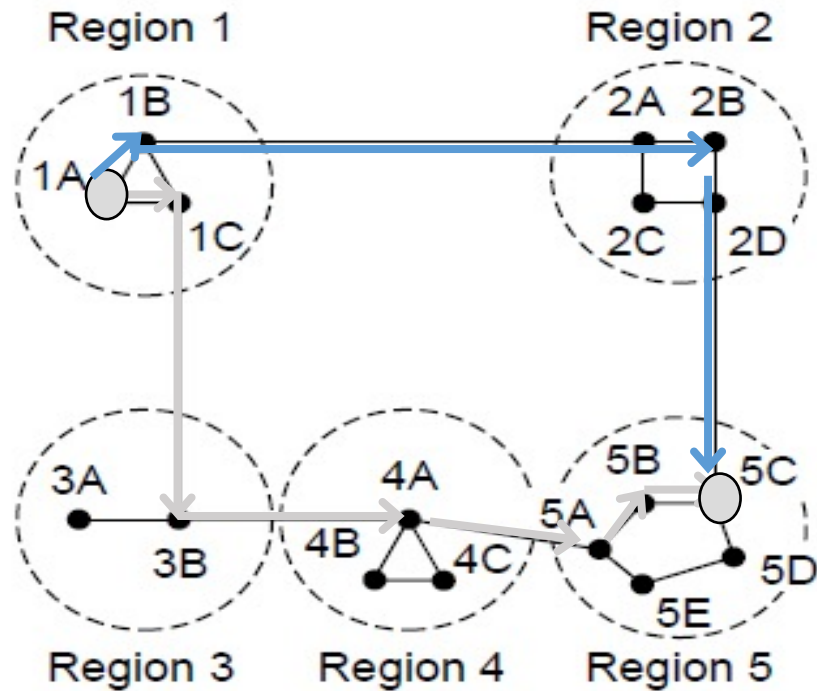

Full table for 1A

Dest.	Line	Hops
1A	—	—
1B	1B	1
1C	1C	1
2A	1B	2
2B	1B	3
2C	1B	3
2D	1B	4
3A	1C	3
3B	1C	2
4A	1C	3
4B	1C	4
4C	1C	4
5A	1C	4
5B	1C	5
5C	1B	5
5D	1C	6
5E	1C	5

Hierarchical table for 1A

Dest.	Line	Hops
1A	—	—
1B	1B	1
1C	1C	1
2	1B	2
3	1C	2
4	1C	3
5	1C	4

1C is best route to region 5, except for destination 5C

# Observations

- Outside a region, nodes have one route to all hosts within the region
  - This gives savings in table size, messages and computation
- However, each node may have a different route to an outside region
  - Routing decisions are still made by individual nodes; there is no single decision made by a region

Scaling Idea 2:

IP Prefix Aggregation and Subnets

# Idea

- Scale routing by adjusting the size of IP prefixes
  - Split (subnets) and join (aggregation)

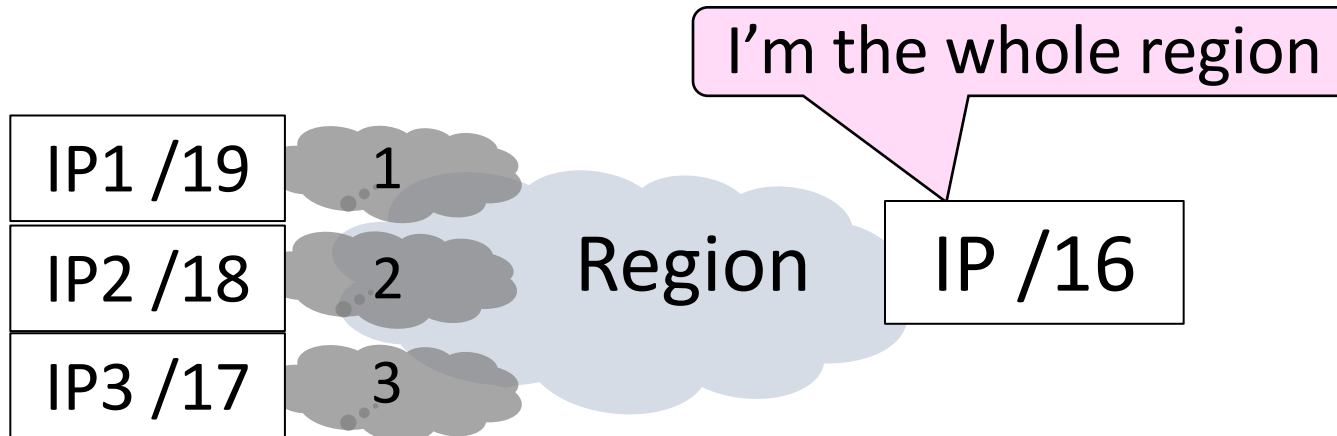

# Recall

- IP addresses are allocated in blocks called IP prefixes, e.g., 18.31.0.0/16
  - Hosts on one network in same prefix
- “/N” prefix has the first N bits fixed and contains  $2^{32-N}$  addresses
  - E.g., a “/24” has 256 addresses
- Routers keep track of prefix lengths
  - Use it as part of longest prefix matching

Routers can change prefix lengths without affecting hosts



# Prefixes and Hierarchy

- IP prefixes help to scale routing, but can go further
  - Use a less specific (larger) IP prefix as a name for a region

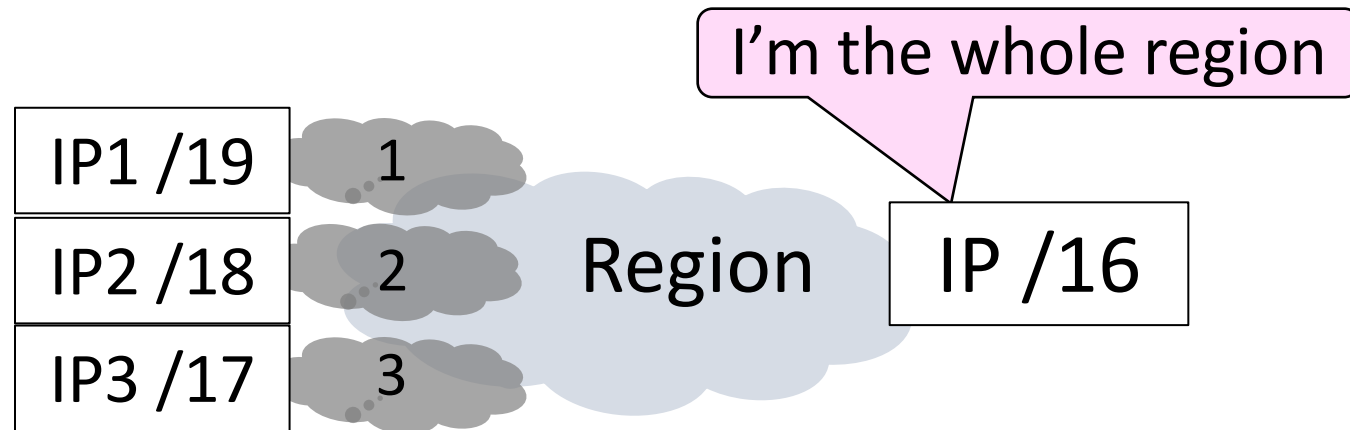

# Subnets and Aggregation

- Two use cases for adjusting the size of IP prefixes; both reduce routing table
  1. Subnets
    - Internally split one large prefix into multiple smaller ones
  2. Aggregation
    - Join multiple smaller prefixes into one large prefix

# Subnets

- Internally split up one IP prefix

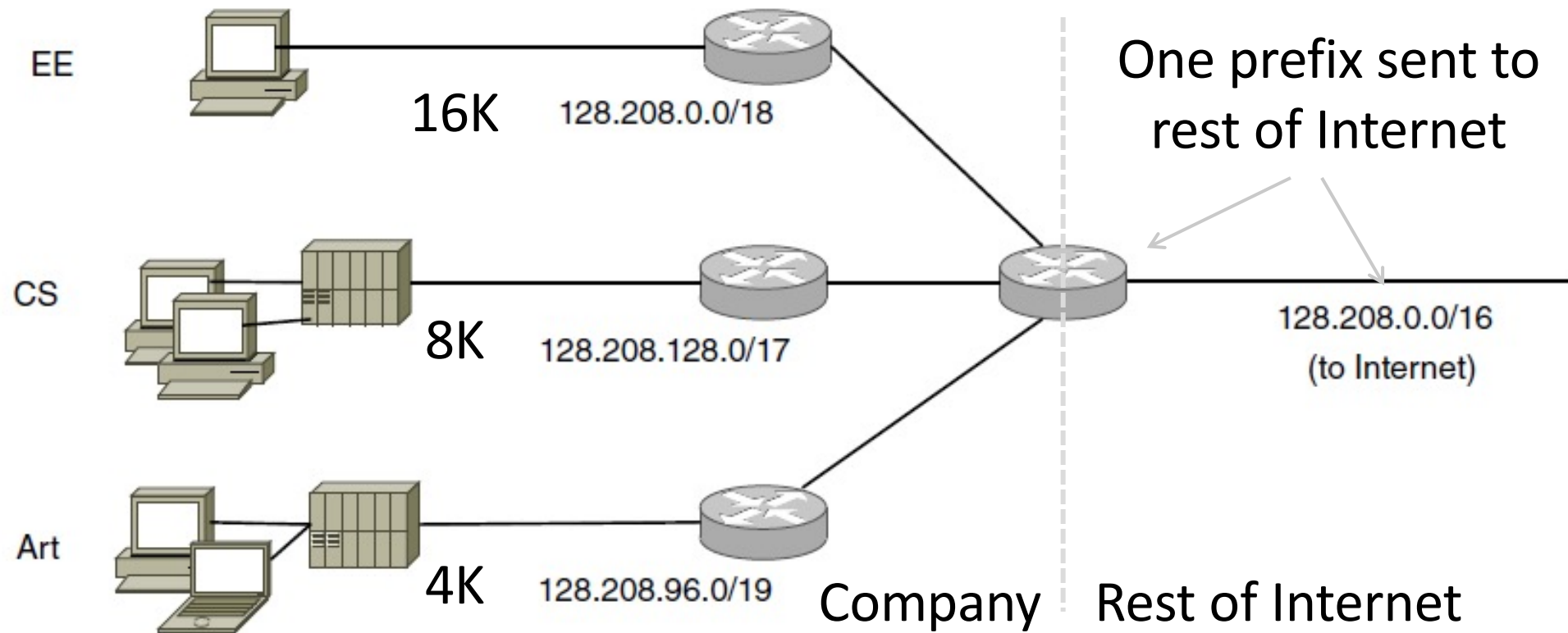

# Aggregation

- Externally join multiple separate IP prefixes

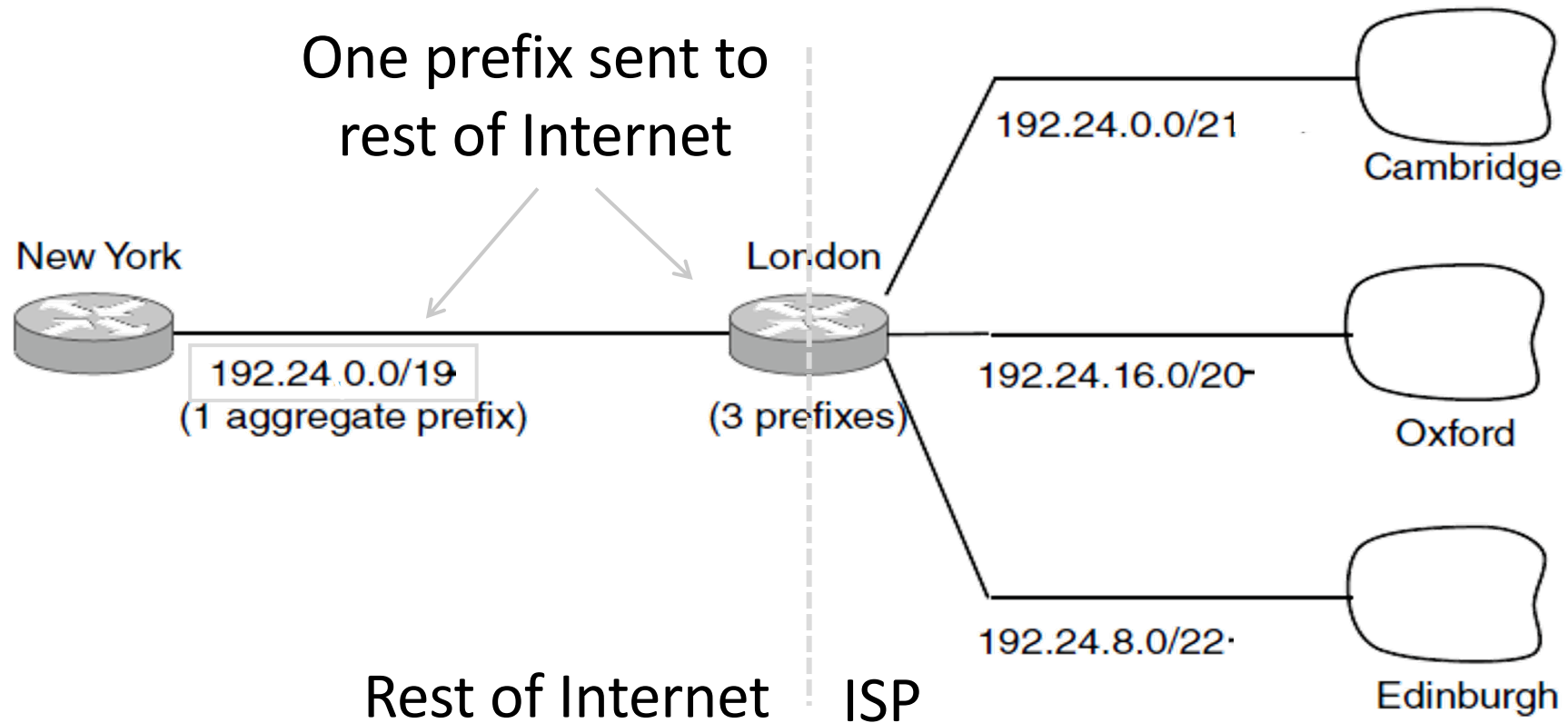

# Routing Process

1. Ship these prefixes or regions around to nearby routers
2. Receive multiple prefixes and the paths of how you got them
3. Build a global routing table

# Internet Routing Growth

Growth of the BGP Table - 1994 to Present

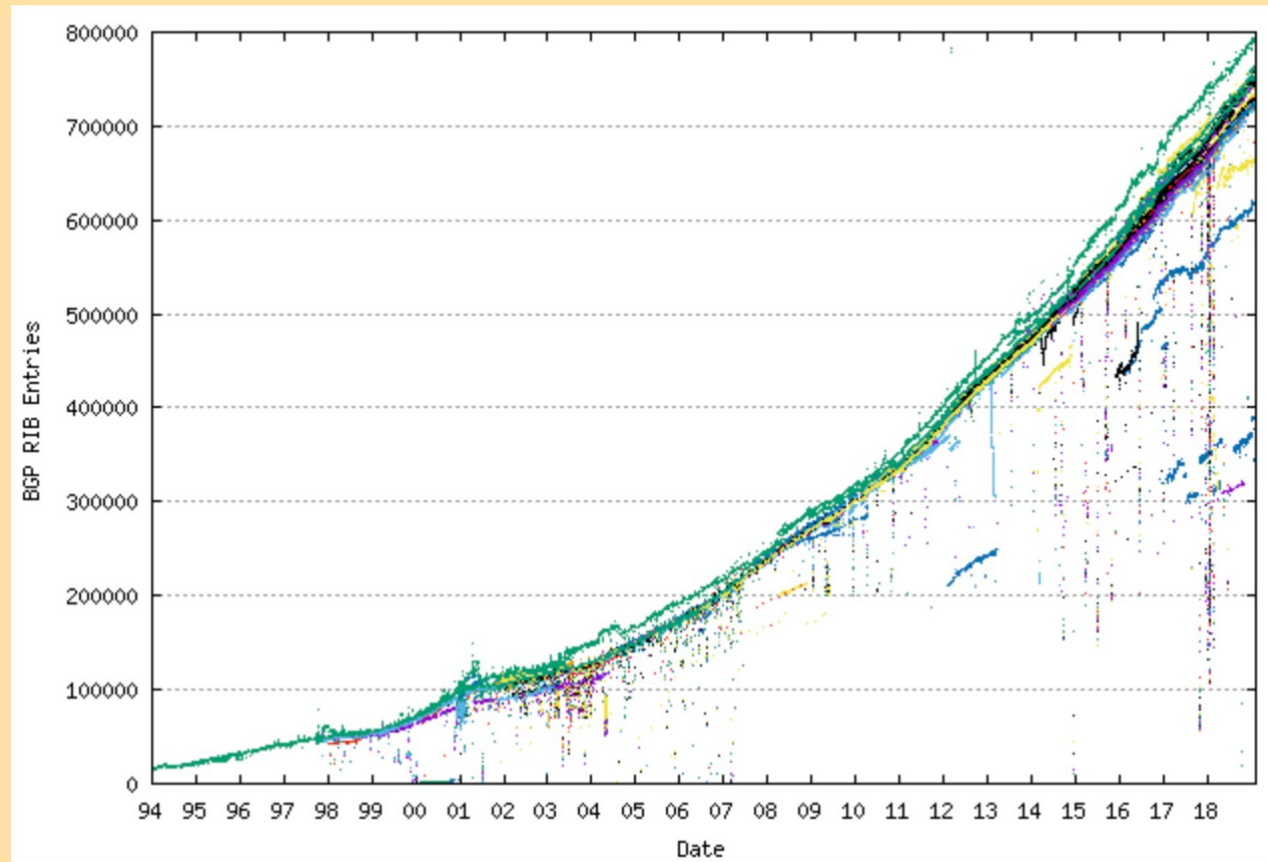

Source: [bgp.potaroo.net](http://bgp.potaroo.net)