

HTTP

HTTP: HyperText Transfer Protocol

- Basis for fetching Web pages

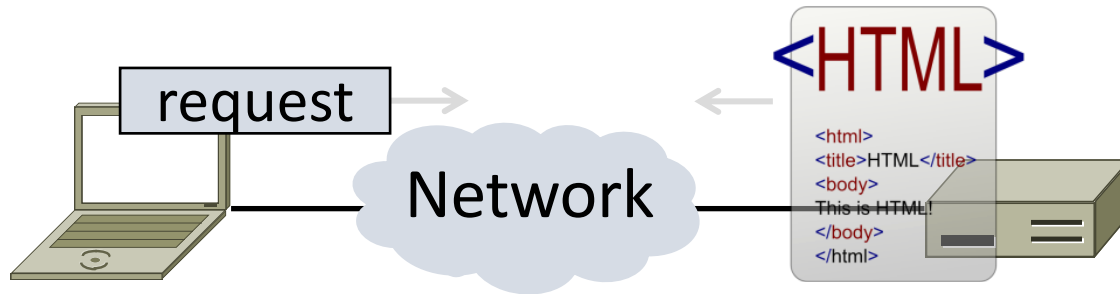

Sir Tim Berners-Lee (1955–)

- Inventor of the Web
 - Dominant Internet app since mid 90s
 - He now directs the W3C
- Developed Web at CERN in '89
 - Browser, server and first HTTP
 - Popularized via Mosaic ('93), Netscape
 - First WWW conference in '94 ...



Source: By Paul Clarke, CC-BY-2.0, via Wikimedia Commons

Web Context

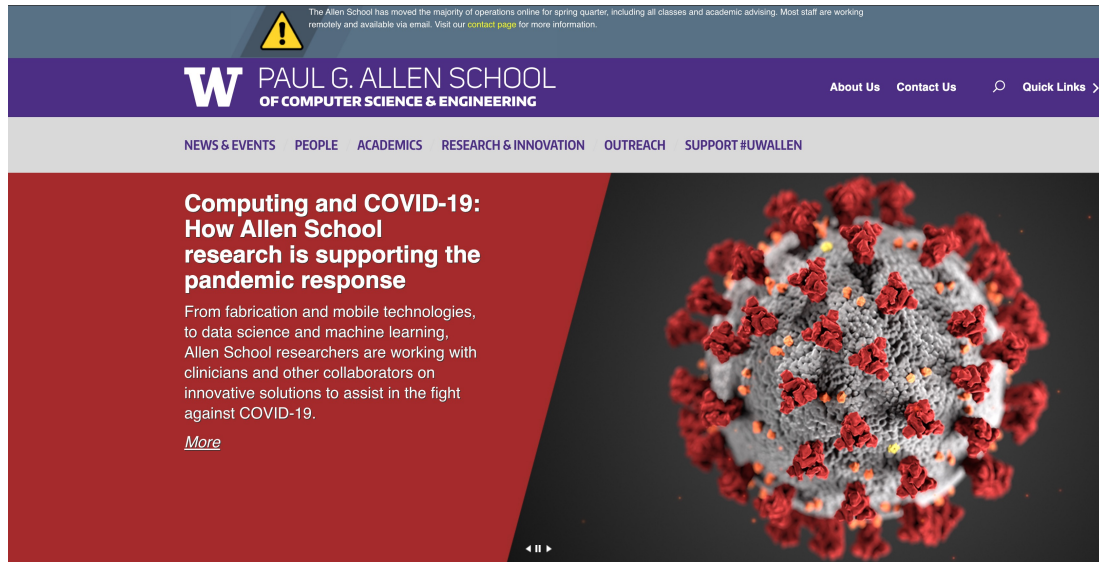

Hyperlink

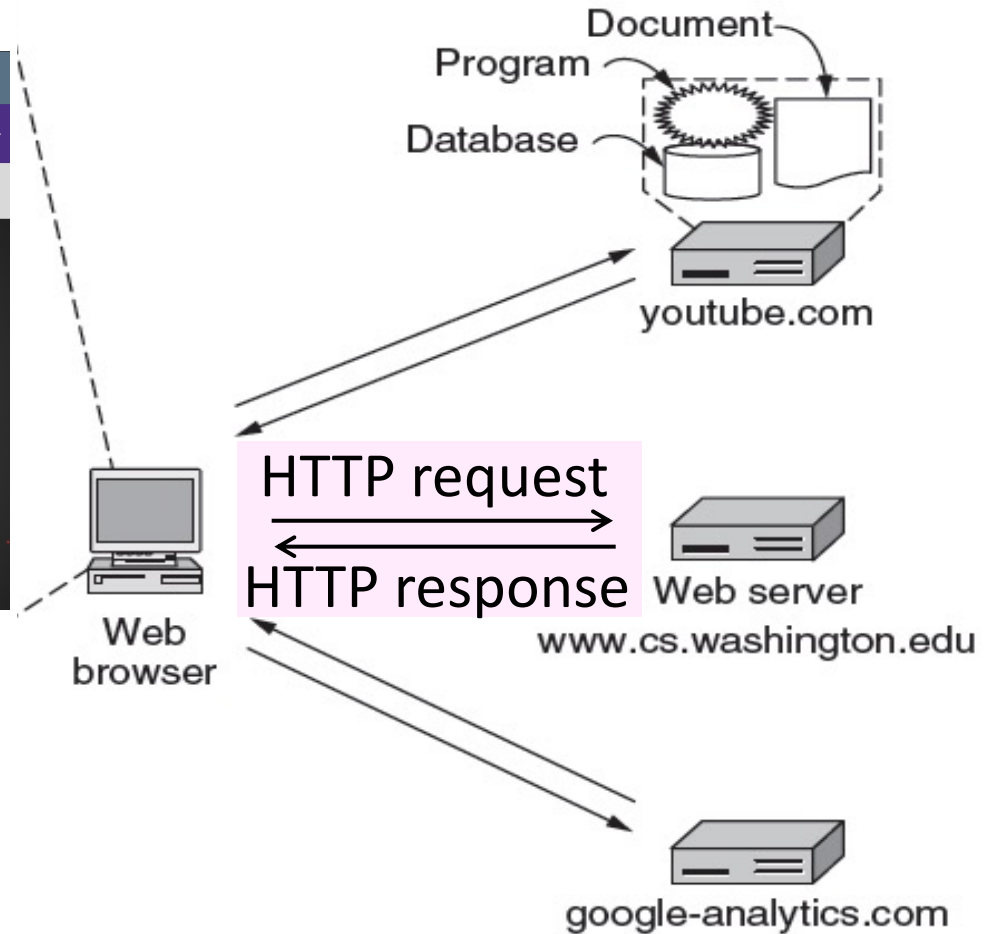

Web Protocol Context

- HTTP is a request/response protocol
 - Runs on TCP, typically port 80
 - Part of browser/server app

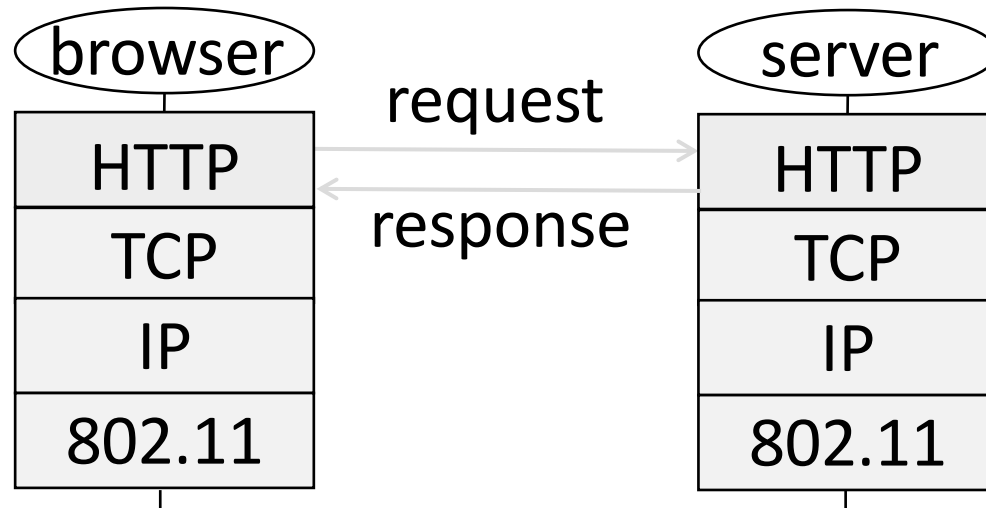

Fetching a Web page with HTTP

- Start with the page URL (Uniform Resource Locator):

`http://en.wikipedia.org/wiki/Vegemite`



- Steps:

1. Resolve the server to IP address (DNS)
2. Set up TCP connection to the server
3. Send HTTP request for the page
4. Await HTTP response for the page
5. Execute and fetch embedded resources, render
6. Clean up any idle TCP connections

HTML

- Hypertext Markup Language (HTML)
 - Uses Extensible Markup Language (XML) to build a markup language for web content
 - Key innovation was the “hyperlink”, an element linking to other HTML elements using URLs
 - Also includes Cascading Style Sheets (CSS) for maintaining look-and-feel across a domain
 - “Browser wars” over specific standards

HTML



DOM (Document Object Model)

- Base primitive for HTML browsers
- Use HTML to create a tree of elements
- Embedded Javascript modifies the DOM based on:
 - User actions
 - Asynchronous Javascript
 - Other server-side actions

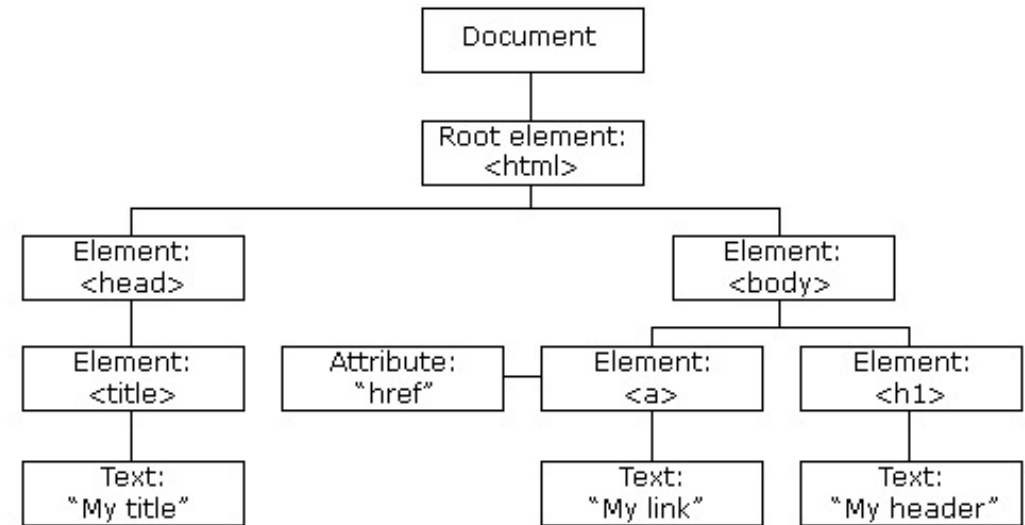

Lets explore a page

- <https://www.cs.washington.edu/>

Static vs Dynamic Web pages

- Static: Just static files, e.g., image
- Dynamic: Page content based on some computation
 - Javascript on client, PHP on server, or both

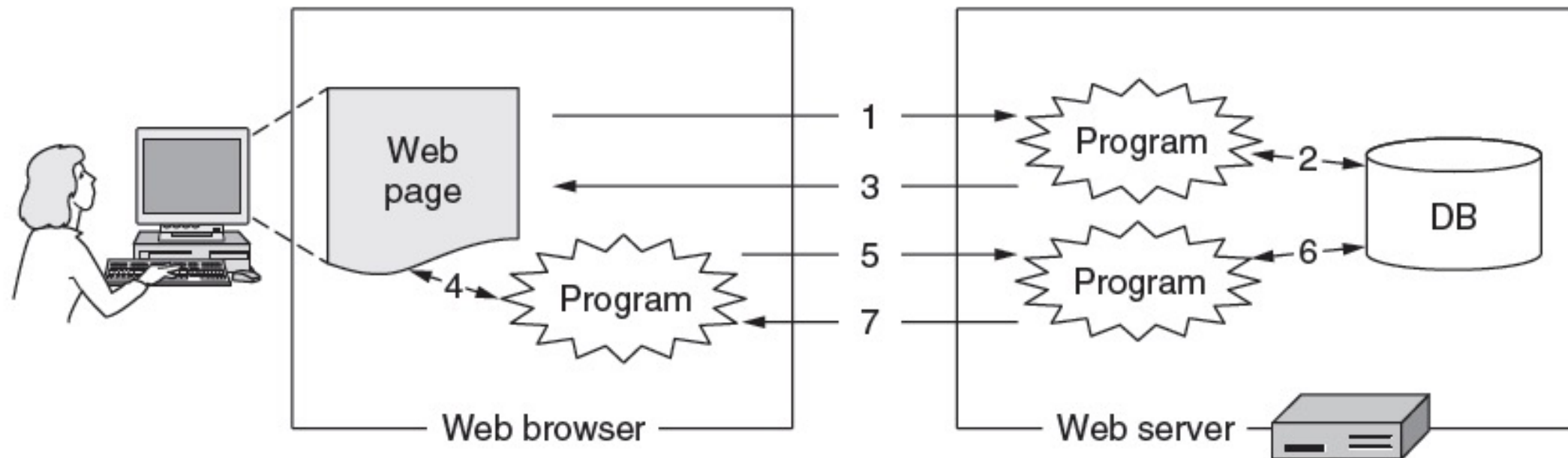

HTTP Protocol

- Originally simple; many options added over time
 - Text-based commands, headers
- Try it yourself: As a “browser” fetching a URL
 - Run “telnet <server name> 80”
 - Enter “GET /index.html HTTP/1.0”
 - Server will return HTTP response

HTTP Protocol (2)

- Commands used in the request

	Method	Description	
Fetch page →	GET	Read a Web page	
	HEAD	Read a Web page's header	
Upload data →	POST	Append to a Web page	
	PUT	Store a Web page	← Basically
	DELETE	Remove the Web page	← defunct
	TRACE	Echo the incoming request	
	CONNECT	Connect through a proxy	
	OPTIONS	Query options for a page	

HTTP Protocol (3)

- Codes returned with the response

	Code	Meaning	Examples
	1xx	Information	100 = server agrees to handle client's request
Yes! →	2xx	Success	200 = request succeeded; 204 = no content present
	3xx	Redirection	301 = page moved; 304 = cached page still valid
	4xx	Client error	403 = forbidden page; 404 = page not found
	5xx	Server error	500 = internal server error; 503 = try again later

Performance

PLT (Page Load Time)

- PLT is a key measure of web performance
 - From click until user sees page
 - Small increases in PLT decrease sales
- PLT depends on many factors
 - Structure of page/content
 - HTTP (and TCP!) protocol
 - Network RTT and bandwidth

Early Performance

- HTTP/1.0 used one TCP connection per web resource
 - Made HTTP very easy to build
 - But gave fairly poor PLT...

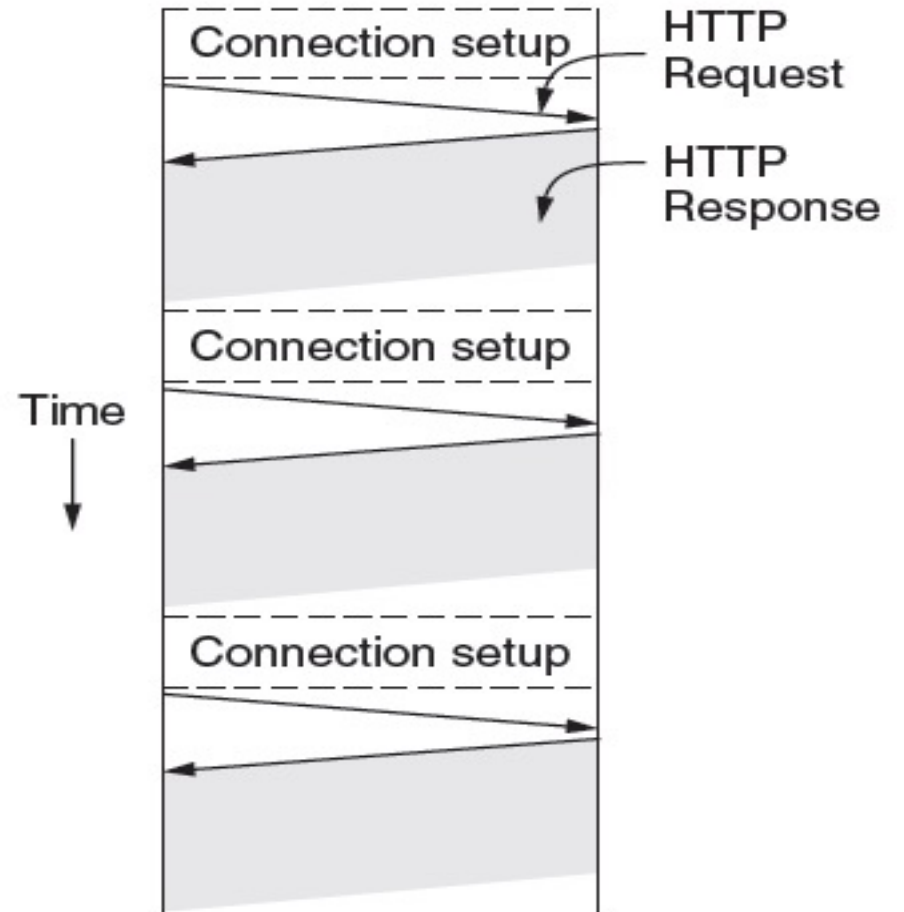

Reasons for Poor PLT

- Sequential request/responses, even when to different servers
- Multiple TCP connection setups to the same server
 - Multiple TCP slow-start phases
- Network is not used effectively
 - Worse with many small resources

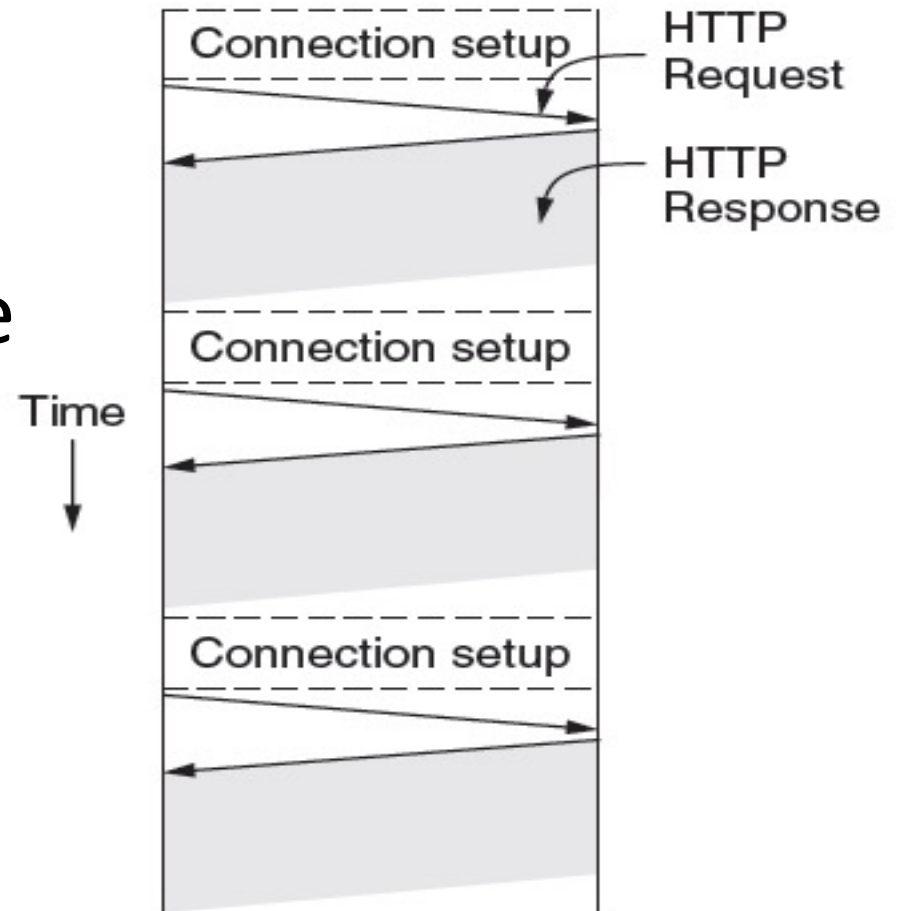

Ways to Improve PLT

1. Reduce content size for transfer
 - Smaller images, gzip
2. Make better use of the network
 - Next
3. Avoid fetching same content
 - Caching and proxies [later]
4. Move content closer to client
 - CDNs [later later]

Better Network Use: Parallel Connections

- Browser runs multiple (say, 8) parallel HTTP instances
 - Server is unchanged; already handled concurrent requests for many clients
- How does this help?
 - Single HTTP wasn't using network much ...
 - So parallel connections aren't slowed much
 - Pulls in completion time of last fetch

Better Network Use: Persistent Connections

- Parallel connections compete with each other for network resources
 - 1 parallel client \approx 8 sequential clients?
 - Exacerbates network bursts, and loss
- Persistent connections
 - Make 1 TCP connection to 1 server
 - Use it for multiple HTTP requests

Persistent Connections

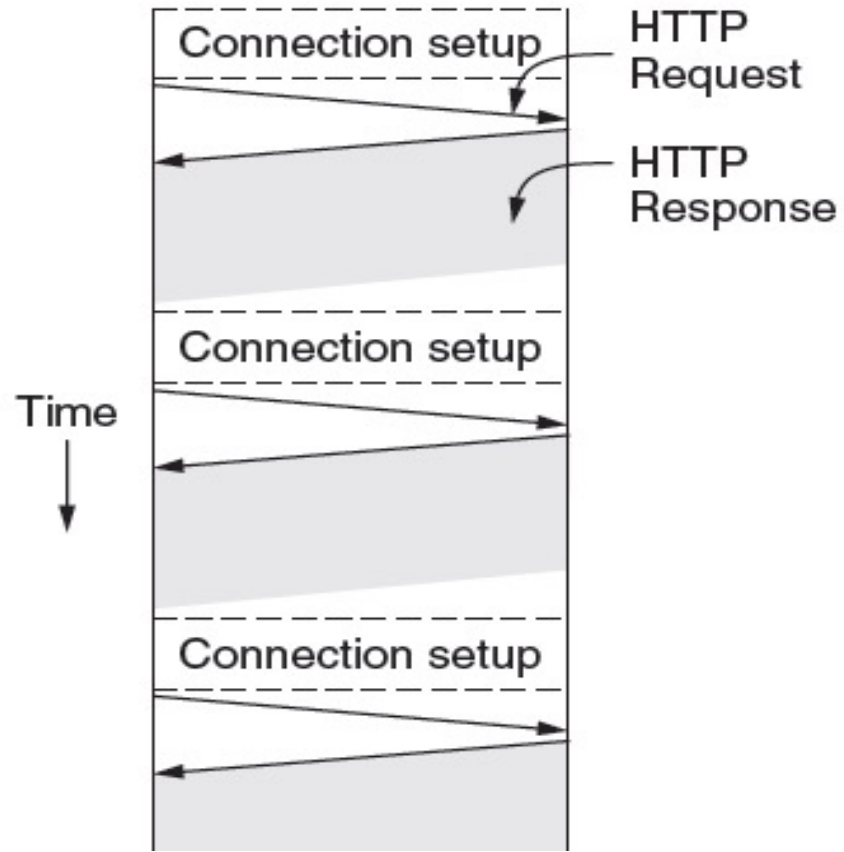

One request per connection

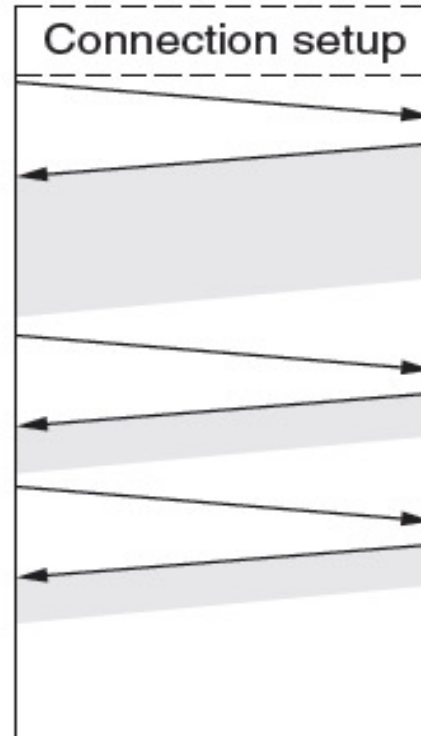

Persistent connections

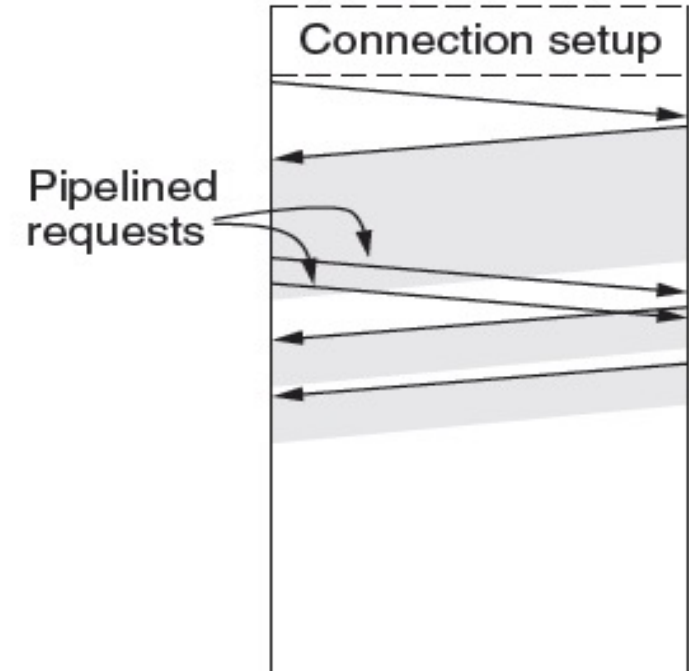

Persistent connections + pipelining

Persistent Connections (2)

- Widely used as part of HTTP/1.1
 - Supports optional pipelining
 - PLT benefits depending on page structure, but easy on network

But we didn't stop there

Web Caching and Proxies

Web Caching

- Users often revisit web pages
 - Big win from reusing local copy, aka, caching

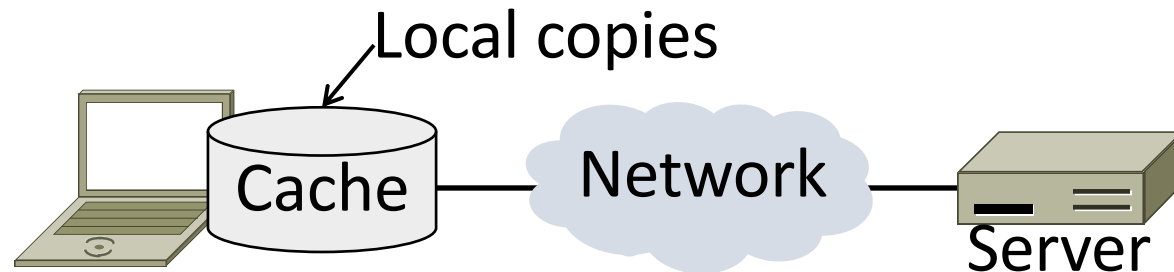

- Key question:
 - When is it OK to reuse local copy?

Locally Determine Validity of Cached Content

- Based on expiry information such as “Expires” header
- Or a heuristic (cacheable, fresh, not modified recently)
- Content is then available right away

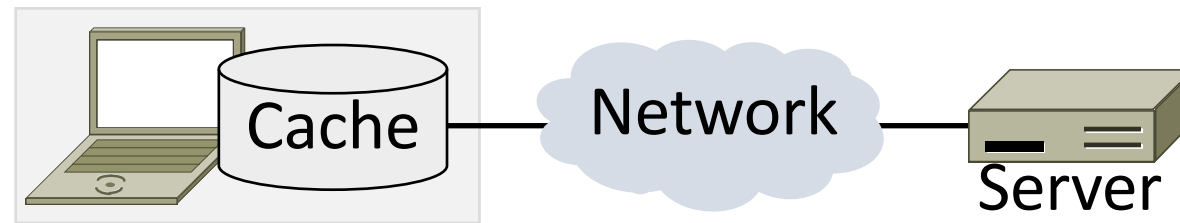

Use Server to Validate Cached Content

- Based on “Last-Modified” header from server
- Or based on “Etag” header from server
- Content is available after 1 RTT (if connection open)

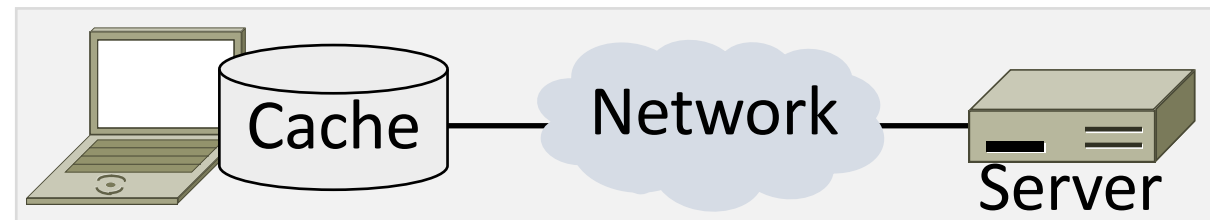

Web Caching: Putting it together

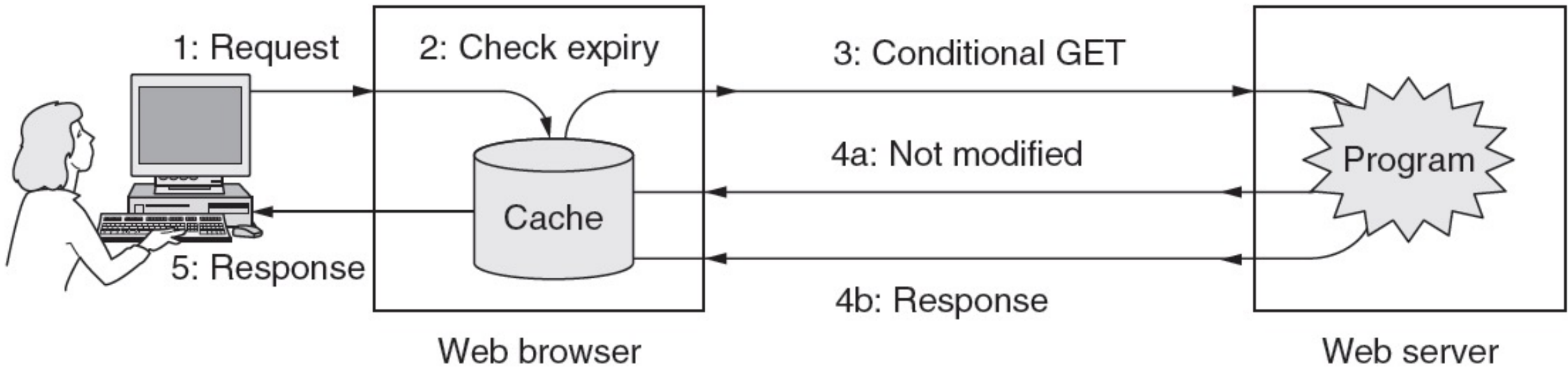

Web Proxies

- Place intermediary between clients and servers
- Benefits for clients include a shared cache
 - Limited by secure / dynamic content
 - Also limited by “long tail”
- Organizational access policies too!

Web Proxies in Action

- Clients contact proxy; proxy contacts server

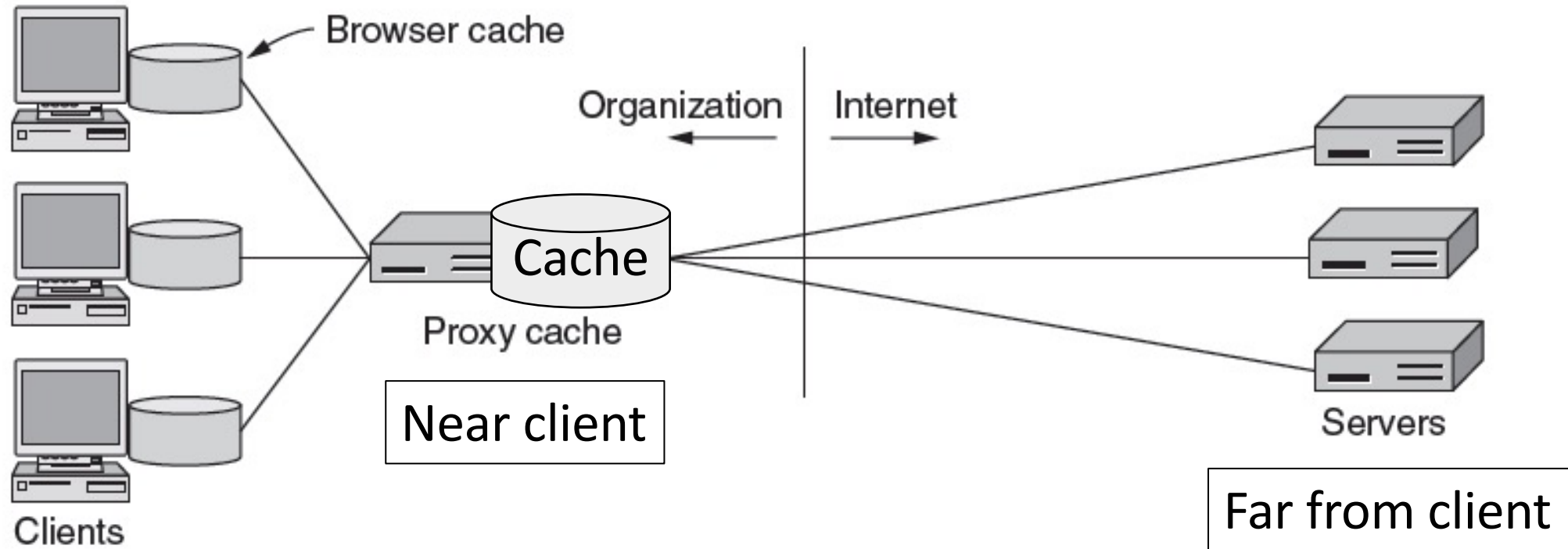

CDNs

Content Delivery Networks

- As the Web took off, traffic volumes grew and grew.
 1. Concentrated load on popular servers
 2. Led to congested networks
 3. Gave a poor user experience
- Idea:
 - Place popular content near clients
 - Helps with all three issues above

Before CDNs

- Sending content from the source server to 4 users takes $4 \times 3 = 12$ “network hops” in the example

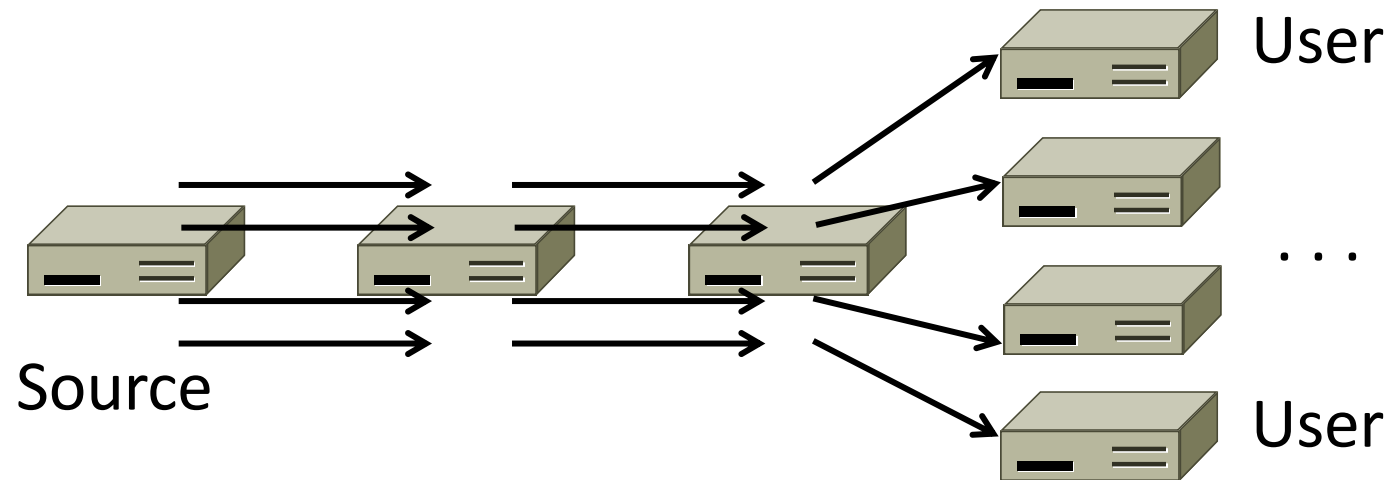

After CDNs

- Sending content via replicas takes only $4 + 2 = 6$ “network hops”

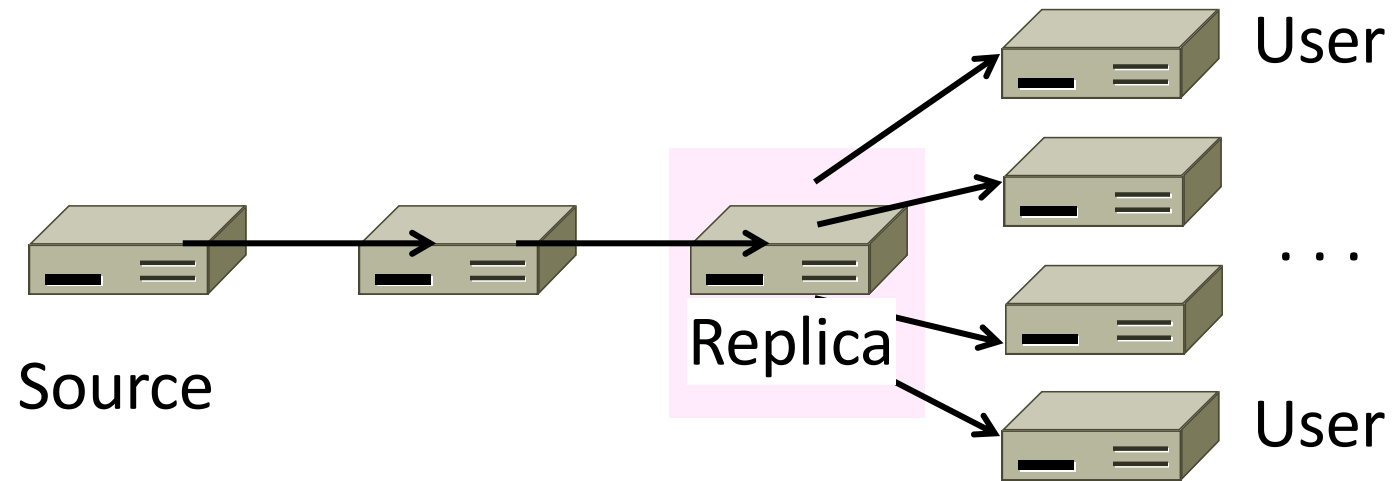

After CDNs (2)

- Benefits assuming popular content:
 - Reduces source server, network load
 - Improves user experience

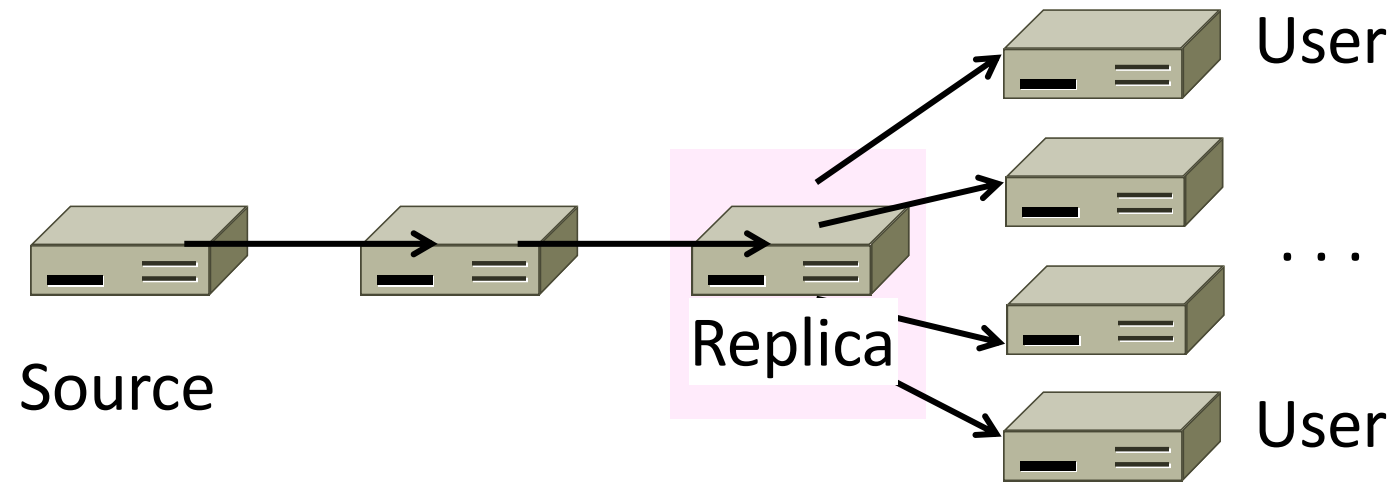

Popularity of Content

- Zipf's Law: few popular items, many unpopular ones; both matter

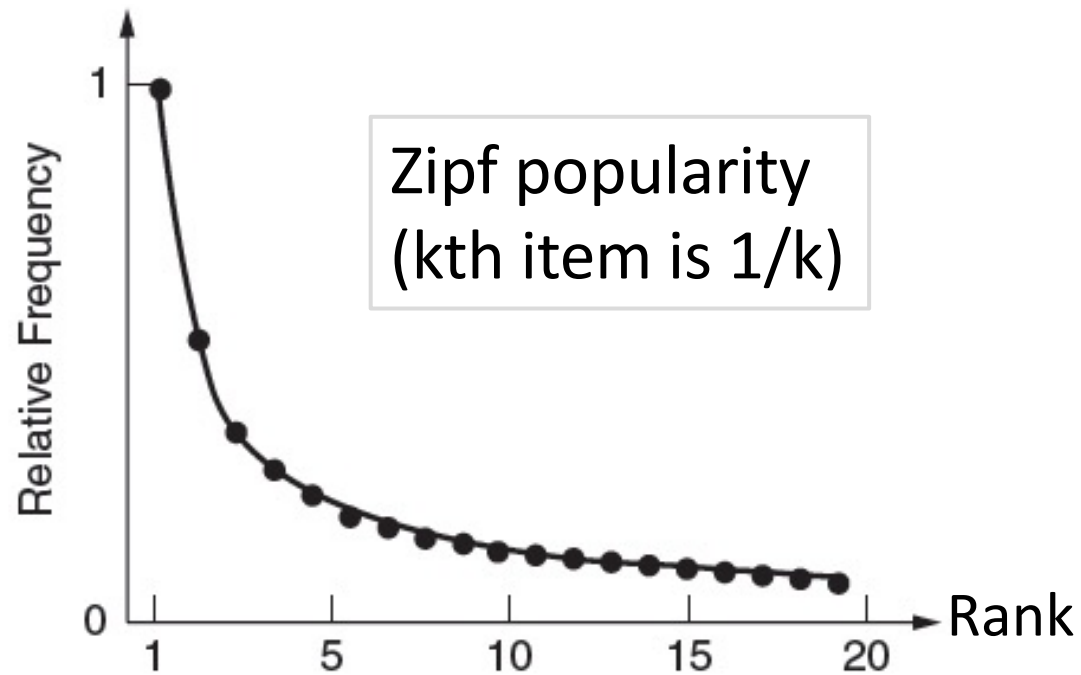

George Zipf (1902-1950)



Source: Wikipedia

How to place content near clients?

- Idea 1: Use browser and proxy caches
 - Helps, but limited to one client or clients in one organization
 - Want to place replicas across the Internet for use by all nearby clients
- Idea 2: Map clients to a nearby replica
 - Done via clever use of DNS

Content Delivery Network

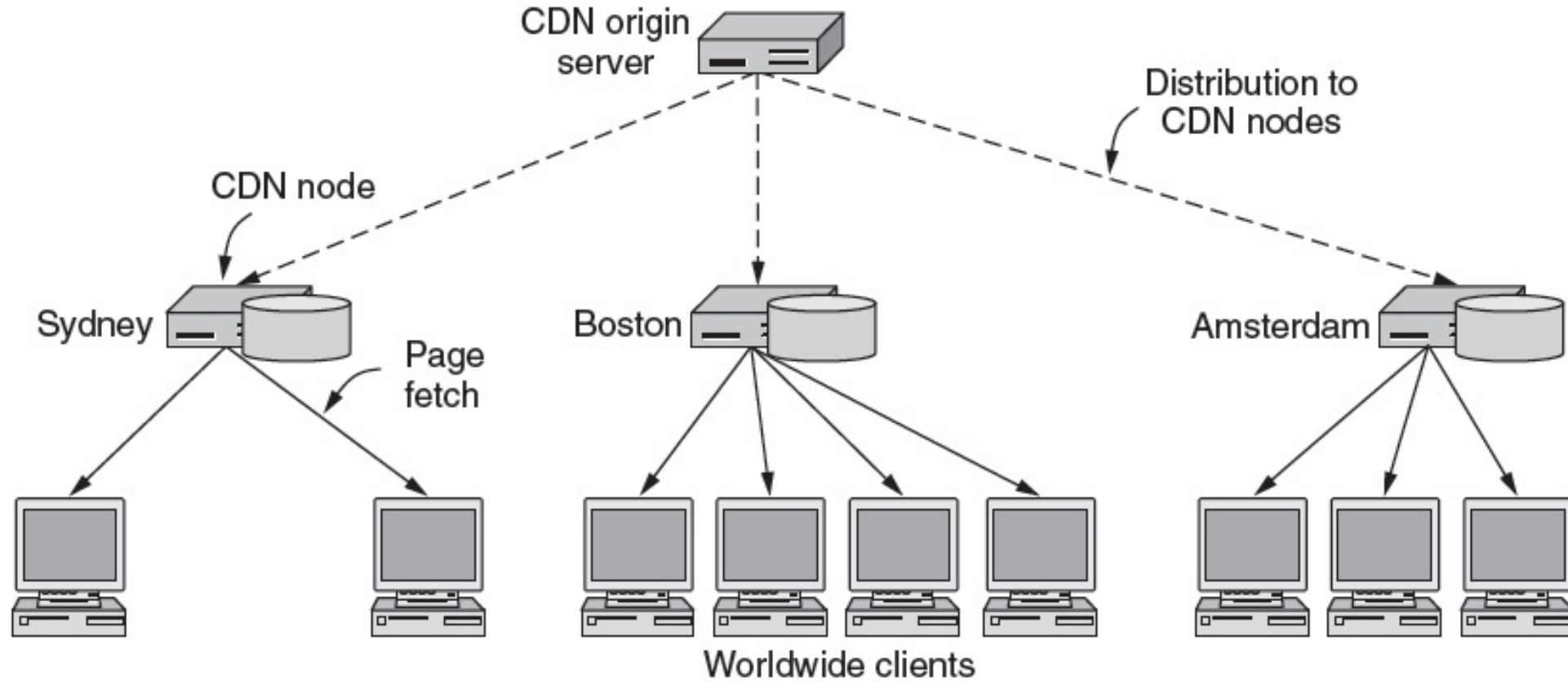

Content Delivery Network (2)

- DNS gives different answers to clients
 - Tell each client the nearest replica (map client IP)

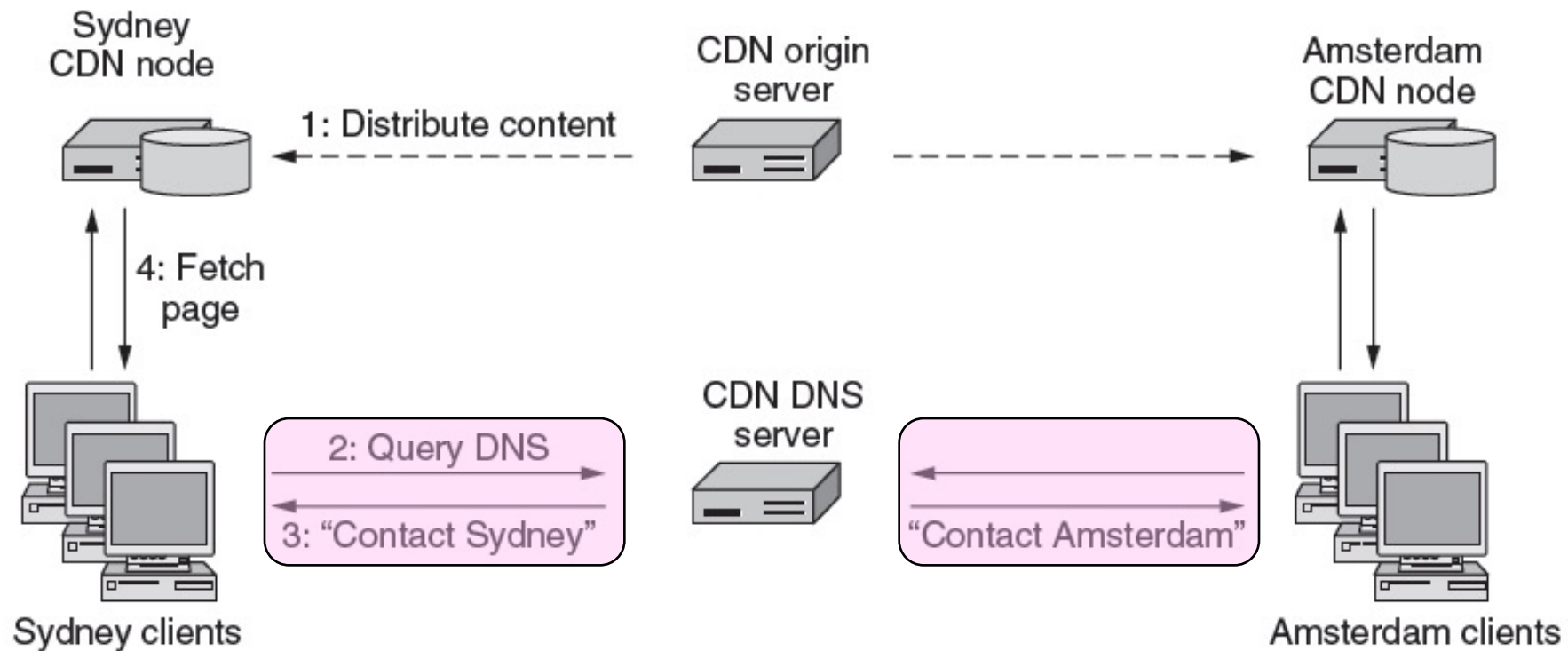

Business Model

- Clever model pioneered by Akamai
 - Placing site replica at an ISP is win-win
 - Improves site experience and reduces ISP bandwidth usage

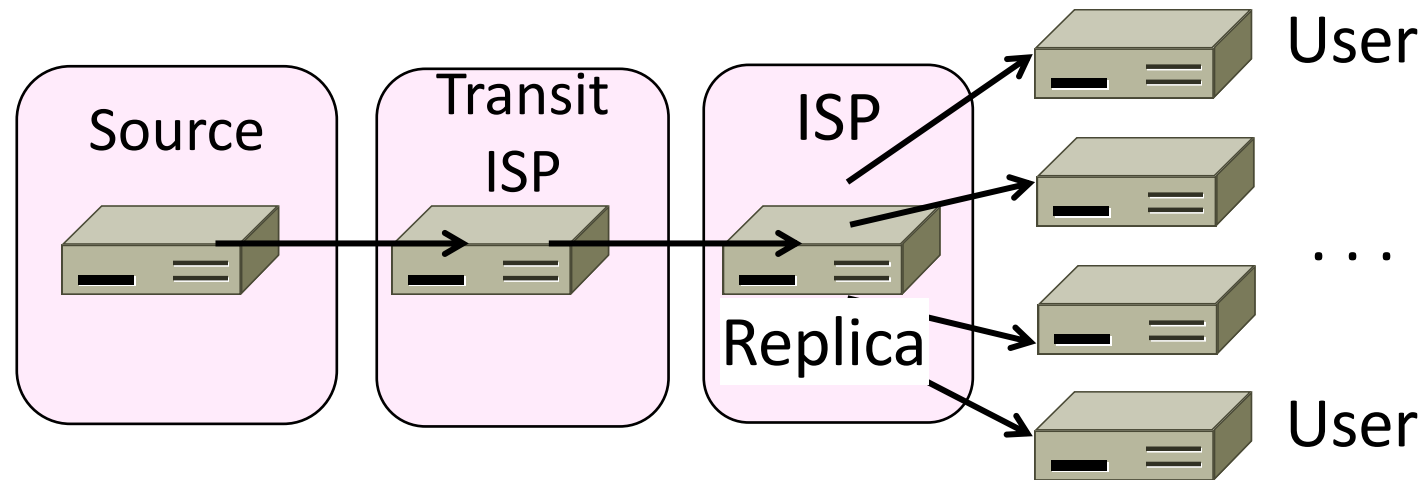

CDNs Issues

- Performance: How accurate can the IP map be?
- Dynamic pages: What about dynamic content?
- Security: How to cache/forward encrypted content?
- Privacy: What about private information?