



# TRDB\_D5M



## 5 Mega Pixel Digital Camera Development Kit

## Page Index

<b>CHAPTER 1</b>	<b>ABOUT THE KIT</b> .....	<b>1</b>
1.1	KIT CONTENTS.....	1
1.2	ASSEMBLE THE CAMERA.....	2
1.3	GETTING HELP.....	3
<b>CHAPTER 2</b>	<b>TRDB_D5M</b> .....	<b>4</b>
2.1	FEATURES.....	4
2.2	PIN-OUT OF THE 40-PIN CONNECTOR ON TRDB-D5M.....	6
2.3	PIN DESCRIPTION OF THE 40-PIN INTERFACE OF TRDB_D5M.....	7
<b>CHAPTER 3</b>	<b>DIGITAL CAMERA DESIGN DEMONSTRATION</b> .....	<b>8</b>
3.1	DEMONSTRATION SETUP.....	8
3.2	CONFIGURING THE CAMERA AND LOAD THE IMAGE CAPTURED TO YOUR PC (DE2-70 BOARD USERS).....	9
3.3	CONFIGURING THE CAMERA (DE2 BOARD USERS).....	12
3.4	CONFIGURING THE CAMERA (DE1 BOARD USERS).....	14
3.5	BLOCK DIAGRAM OF THE REFERENCE DESIGN.....	15
<b>CHAPTER 4</b>	<b>APPENDIX</b> .....	<b>16</b>
4.1	REVISION HISTORY.....	16
4.2	ALWAYS VISIT TRDB_D5M WEBPAGE FOR NEW APPLICATIONS.....	16

# About the Kit

The TRDB\_D5M Kit provides everything you need to develop a 5 Mega Pixel Digital Camera on the Altera DE2-70 / DE2 / DE1 boards. The kit contains hardware design (in Verilog) and software to load the picture taken into a PC and save it as a BMP or JPG file (DE2-70 only). The Getting Started User Guide enables users to exercise the digital camera functions. This chapter provides users key information about the kit.

---



---

## Kit Contents

---

Figure 1.1 shows the photo of the TRDB\_D5M package. The package includes:

1. The TRDB\_D5M (**D5M**) board with one CMOS sensor.
2. A reference design CD.



Figure 1.1. The TRDB\_D5M (**D5M**) Package Content (CD not including)

---

## Assemble the Camera

---

Please follow the step below to assemble your camera:

1. Connect the D5M to your DE2-70 board as shown in Figure 1.2.

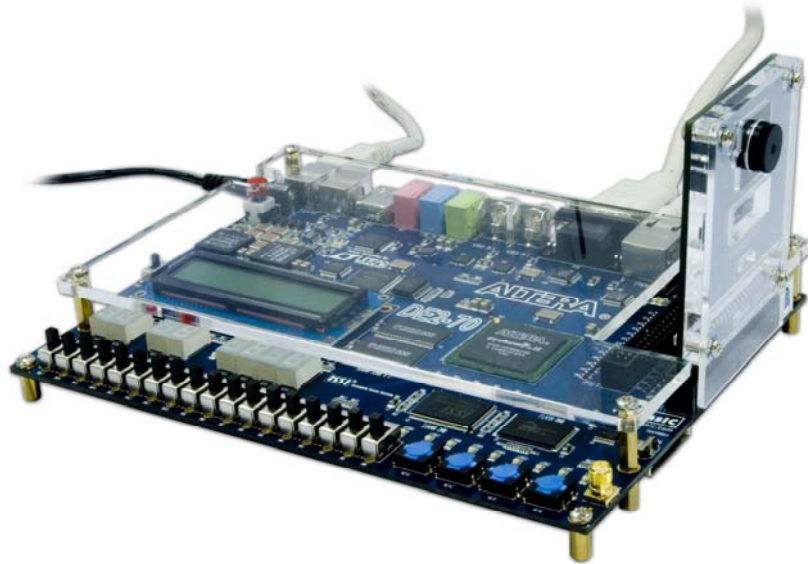

Figure 1.2 Connect the D5M to DE2-70 board's expansion port (**outermost port**).

2. Connect the D5M to your DE2 board as shown in Figure 1.3.

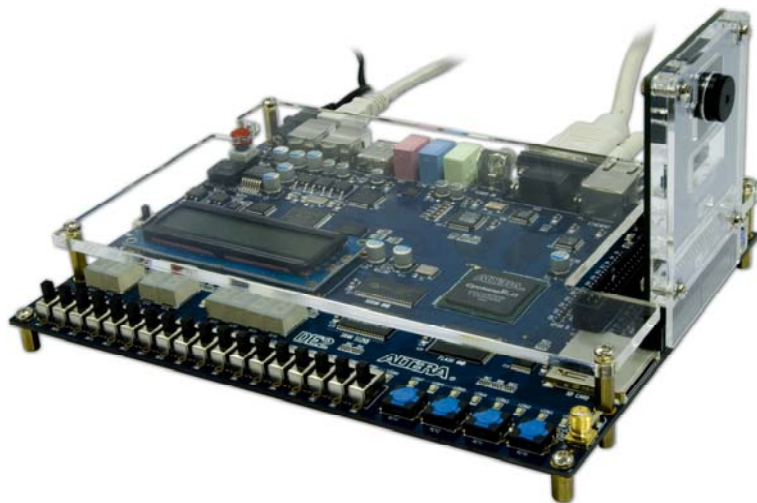

Figure 1.3 Connect the D5M to DE2 board's expansion port (**outermost port**).

3. Connect the D5M to your DE1 board as shown in Figure 1.4.

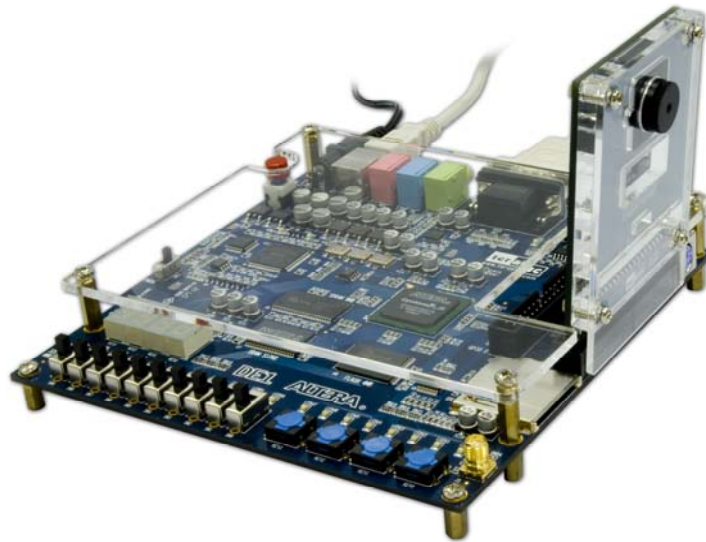

Figure 1.4 Connect the D5M to DE1 board's expansion port (**outermost port**).

---

---

## Getting Help

---

Here are some places to get help if you encounter any problem:

- ✓ Email to [support@terasic.com](mailto:support@terasic.com)
- ✓ Taiwan & China: +886-3-550-8800
- ✓ Korea : +82-2-512-7661
- ✓ Japan: +81-428-77-7000
- ✓ English Support Line: +1-408-512-1336

Chapter

2

# TRDB\_D5M

This chapter will illustrate the technical details users need to know to modify the reference design for their own purpose.

---



---

## Features

---



The D5M kit is designed to use the same strict design and layout practices used in high-end consumer products. The feature set is listed below:

1. High frame rate
2. Superior low-light performance
3. Low dark current
4. Global reset release, which starts the exposure of all rows simultaneously
5. Bulb exposure mode, for arbitrary exposure times
6. Snapshot mode to take frames on demand
7. Horizontal and vertical mirror image
8. Column and row skip modes to reduce image size without reducing field-of-view
9. Column and row binning modes to improve image quality when resizing
10. Simple two-wire serial interface
11. Programmable controls: gain, frame rate, frame size, exposure
12. Automatic black level calibration
13. On-chip PLL

### Key Performance Parameters

Parameter		Value
Active pixels		2,592H x 1,944V
Pixel size		2.2 $\mu$ m x 2.2 $\mu$ m
Color filter array		RGB Bayer pattern
Shutter type		Global reset release (GRR),
Maximum data rate/master clock		96 Mp/s at 96 MHz
Frame rate	Full resolution	Programmable up to 15 fps
	VGA (640 x 480)	Programmable up to 70 fps
ADC resolution		12-bit
Responsivity		1.4 V/lux-sec (550nm)
Pixel dynamic range		70.1dB
SNRMAX		38.1dB
Supply Voltage	Power	3.3V
	I/O	1.7V ~ 3.1V

**Note.** For detail specification of D5M, please refer to THDB-D5M\_Hardware specification.PDF

## Pin-out of the 40-pin connector on TRDB-D5M

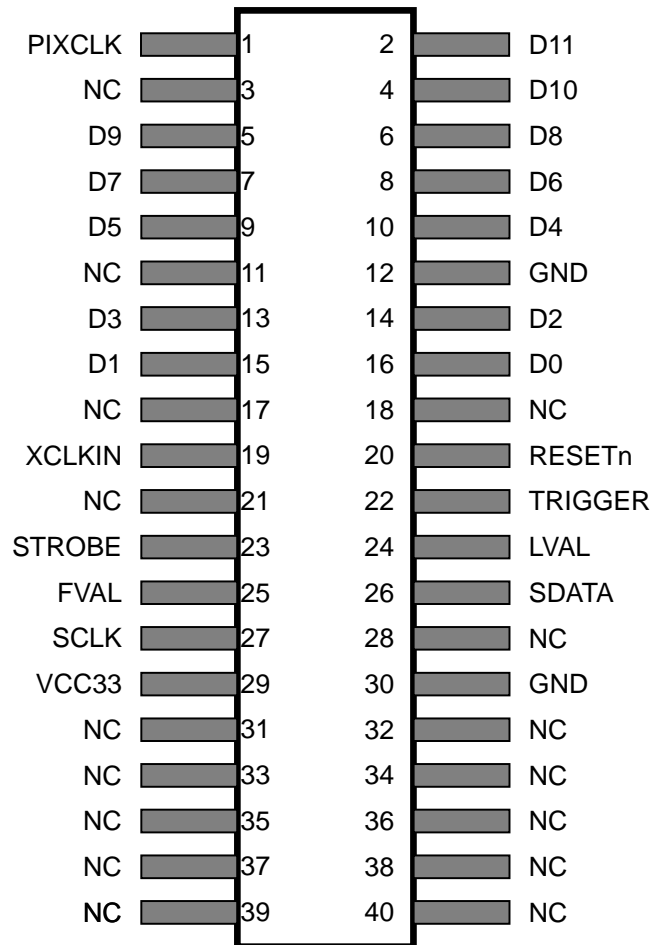

Figure 2.1. The pin-out of the 40-pin connector on TRDB\_D5M



## Pin Description of the 40-pin Interface of TRDB\_D5M

The TRDB\_D5M has a 40-pin connector on the board. The pin description of the 40-pin connector follows:

Pin Numbers	Name	Direction	Description
1	PIXCLK	Output	Pixel clock.
2	D[11]	Output	Pixel data Bit 11
3	NC	N/A	Not Connect
4	D[10]	Output	Pixel data Bit 10
5	D[9]	Output	Pixel data Bit 9
6	D[8]	Output	Pixel data Bit 8
7	D[7]	Output	Pixel data Bit 7
8	D[6]	Output	Pixel data Bit 6
9	D[5]	Output	Pixel data Bit 5
10	D[4]	Output	Pixel data Bit 4
11	NC	N/A	Not Connect
12	GND	N/A	Ground
13	D[3]	Output	Pixel data Bit 3
14	D[2]	Output	Pixel data Bit 2
15	D[1]	Output	Pixel data Bit 1
16	D[0]	Output	Pixel data Bit 0
17	NC	N/A	Not Connect
18	NC	N/A	Not Connect
19	XCLKIN	Input	External input clock
20	RESETn	Input	D5M reset
21	NC	N/A	Not Connect
22	TRIGGER	Input	Snapshot trigger
23	STROBE	Output	Snapshot strobe
24	LVAL	Output	Line valid
25	FVAL	Output	Frame valid
26	SDATA	I/O	Serial data
27	SCLK	Input	Serial clock
28	NC	N/A	Not Connect
29	VCC33	N/A	Power 3.3V
30	GND	N/A	Ground
31	NC	N/A	Not Connect
32	NC	N/A	Not Connect
33	NC	N/A	Not Connect
34	NC	N/A	Not Connect
35	NC	N/A	Not Connect
36	NC	N/A	Not Connect
37	NC	N/A	Not Connect
38	NC	N/A	Not Connect
39	NC	N/A	Not Connect
40	NC	N/A	Not Connect

Chapter

3

# Digital Camera Design Demonstration

This chapter illustrates how to exercise the digital camera reference design provided with the kit. Users can follow the instructions in this chapter to build a 5 Mega Pixel camera using their DE2-70 / DE2 / DE1 in minutes.

## Demonstration Setup



The Demonstration configuration is illustrated in Figure 3.1. The image raw data is sent from D5M to the DE2-70 board. The FPGA on the DE2-70 board is handling image processing part and converts the data to RGB format to display on the VGA monitor. The image captured at SDRAM can be taken at anytime (snapshot) and uploaded to a PC as a BMP/JPG file.

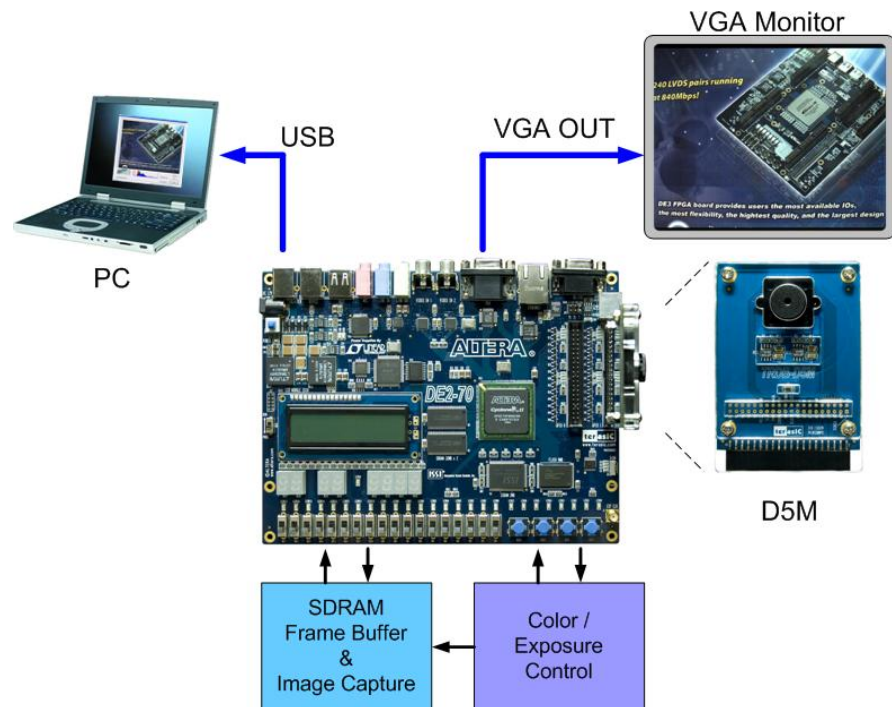

Figure 3.1. The Digital Camera Demo configuration setup

## Configuring the Camera and Load the Image Captured to Your PC (DE2-70 Board Users)



Locate the project directory from the CD-ROM included and follow the steps below:

Directory: DE2\_70\_CAMERA / SW

FPGA Bitstream Used: DE2\_70\_CAMERA.sof

1. Ensure the connection is made correctly as shown in Figure 3.2. Make sure the D5M is connected to **J5 (GPIO 1)** of the DE2-70 board.
2. Copy the directory DE2\_70\_CAMERA from D5M System CD-ROM to the host computer.
3. Execute the *DE2\_70\_CAMERA.exe* from the directory DE2\_70\_CAMERA / SW.
4. Click the '**Download Code**' button. (Error message will pop up for warning since the DE2-70 is loaded with factory default image, which cannot be transmitted. Click '**OK**' button to skip the error message and click 'Download Code' to proceed.
5. Connect the VGA output of the DE2-70 board to a VGA monitor.
6. Press **KEY0** on the DE2-70 board to reset the circuit.
7. You can press **KEY3** to switch to the FREE RUN mode and you should be able to see whatever the camera captures on the VGA display.
8. Press **KEY2** to take a shot of the photo; you can press **KEY3** again to switch back to **FREE RUN** mode.
9. Users can use the **SW[0]** with **KEY1** to set the exposure time for brightness adjustment of the image captured. When **SW[0]** is set to Off, the brightness of image will be increased as **KEY1** is pressed longer. If **SW[0]** is set to On, the brightness of image will be decreased as **KEY1** is pressed shorter.
10. Set the **SW[16]** to On (upper position), the captured image will be enlarged with **KEY0** and **KEY3** pressed in order.
11. Table 3.1 summarizes the functional keys of the digital camera.

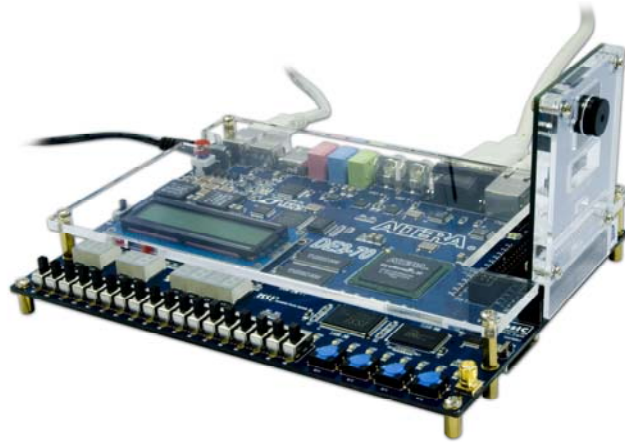

Figure 3.2. The Connection Setup for DE2-70 users

Table 3.1 The functional keys of the digital camera demonstration

Component	Function Description
KEY[0]	Reset circuit
KEY[1]	Set the new exposure time (use with SW[0] )
KEY[2]	Trigger the Image Capture (take a shot)
KEY[3]	Switch to Free Run mode
SW[0]	Off: Extend the exposure time On: Shorten the exposure time
SW[16]	On: ZOOM in Off: Normal display
HEX[7:0]	Frame counter (Display ONLY)

12. Users can upload the captured image to PC by clicking the 'Capture' button of the 'DE2\_70\_CAMERA.exe' as shown in Figure 3.3. Meanwhile, the digital camera is set to photo-taking mode. Press **KEY3** to switch back to FREE RUN mode.
13. Click '**Save**' button to save the captured image as a JPG or BMP file.

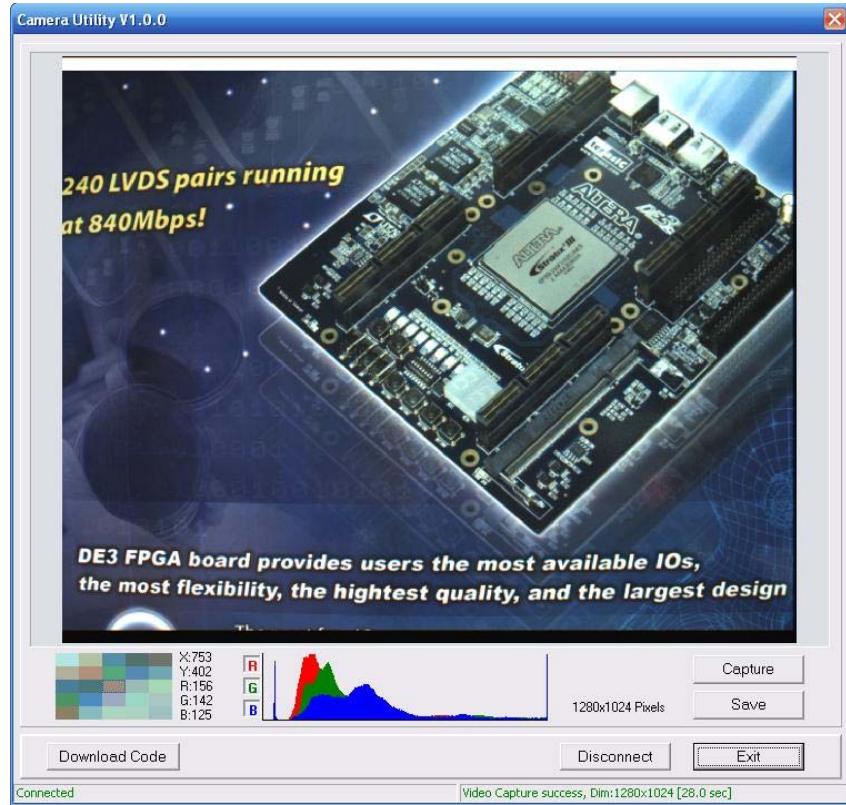

Figure 3.3. The DE2\_70\_camera tool

## Configuring the Camera (DE2 Board Users)



Locate the project directory from the CD-ROM included and follow the steps below:

Directory: DE2\_CAMERA

FPGA Bitstream Used: DE2\_D5M.sof or DE2\_D5M.pof

1. Ensure the connection is set correctly as shown in Figure 3.4. Make sure the D5M is connected to **JP2 (GPIO 1)** of the DE2 board.
2. Download the bitstream (DE2\_D5M.sof/pof) to the DE2 board.
3. Connect the VGA output of the DE2 board to a VGA monitor.
4. Press **KEY0** on the DE2 board to reset the circuit.
5. You can press **KEY3** to switch to the FREE RUN mode and you should be able to see whatever the camera sees on the VGA display.
6. Press **KEY2** to take a shot of the photo; you can press **KEY3** again to switch back to **FREE RUN** mode.
7. Users can use the **SW[0]** with **KEY1** to set the exposure time for brightness adjustment of the image captured. When **SW[0]** is set to Off, the brightness of image will be increased as **KEY1** is pressed longer. If **SW[0]** is set to On, the brightness of image will be decreased as **KEY1** is pressed shorter.
8. Set the **SW[16]** to On (upper position), the captured image will be enlarged with **KEY0** and **KEY3** pressed in order.
9. Table 3.2 summarizes the functional keys of the digital camera.

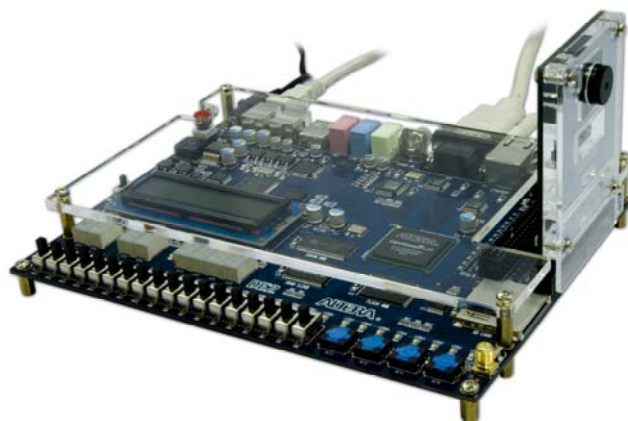

Figure 3.4. The Connection Setup for DE2 users

Table 3.2 The functional keys of the digital camera demonstration

Component	Function Description
KEY[0]	Reset circuit
KEY[1]	Set the new exposure time (use with SW[0] )
KEY[2]	Trigger the Image Capture (take a shot)
KEY[3]	Switch to Free Run mode
SW[0]	Off: Extend the exposure time On: Shorten the exposure time
SW[16]	On: ZOOM in Off: Normal display
HEX[7:0]	Frame counter (Display ONLY)

## Configuring the Camera (DE1 Board Users)



Locate the project directory from the CD-ROM included and follow the steps below:

Directory: DE1\_CAMERA

FPGA Bitstream Used: DE1\_D5M.sof or DE1\_D5M.pof

1. Ensure the connection is set correctly as shown in Figure 3.5. Make sure the D5M is connected to **JP2 (GPIO 1)** of the DE1 board.
2. Download the bitstream (DE1\_D5M.sof/pof) to the DE1 board.
3. Connect the VGA output of the DE1 board to a VGA monitor.
4. Press **KEY0** on the DE1 board to reset the circuit.
5. You can press **KEY3** to switch to the FREE RUN mode and you should be able to see whatever the camera sees on the VGA display.
6. Press **KEY2** to take a shot of the photo; you can press **KEY3** again to switch back to **FREE RUN** mode.
7. Users can use the **SW[0]** with **KEY1** to set the exposure time for brightness adjustment of the image captured. When **SW[0]** is set to Off, the brightness of image will be increased as **KEY1** is pressed longer. If **SW[0]** is set to On, the brightness of image will be decreased as **KEY1** is pressed shorter.
8. Set the **SW[8]** to On (upper position), the captured image will be enlarged with **KEY0** and **KEY3** pressed in order.
9. Table 3.3 summarizes the functional keys of the digital camera.

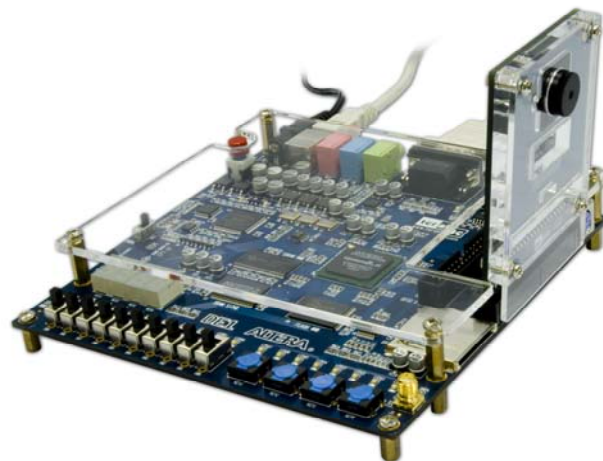

Figure 3.5. The Connection Setup for DE1 users



Table 3.3 The functional keys of the digital camera demonstration

Component	Function Description
KEY[0]	Reset circuit
KEY[1]	Set the new exposure time (use with SW[0] )
KEY[2]	Trigger the Image Capture (take a shot)
KEY[3]	Switch to Free Run mode
SW[0]	Off: Extend the exposure time On: Shorten the exposure time
SW[8]	On: ZOOM in Off: Normal display
HEX[3:0]	Frame counter (Display ONLY)

## Block Diagram of the Reference Design

The complete reference design is also located in the CD-ROM attached. Please refer to the following diagram to help you in reading the code provided.

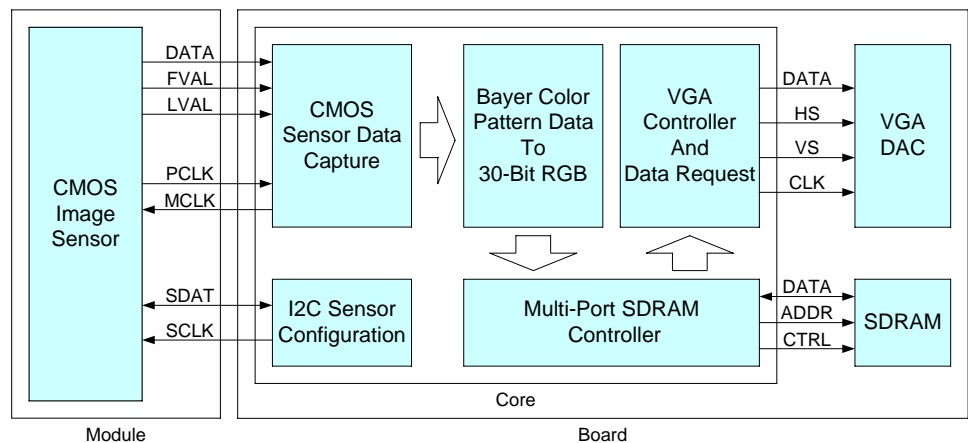

Figure 3.6. The block diagram of the digital camera design

Chapter

4

# Appendix

---

---

## Revision History

---

Date	Change Log
MAR, 24, 2008	Initial Version (Preliminary)

---

---

## Always Visit TRDB\_D5M Webpage for New Applications

---

We will be continuing providing interesting examples and labs on our TRDB\_D5M webpage. Please visit [www.altera.com](http://www.altera.com) or [d5m.terasic.com](http://d5m.terasic.com) for more information.