

Displays and framebuffers

**Brian Curless
CSE 557
Autumn 2013**

Reading

Required

- ◆ Shirley, Chapter 3

Optional

- ◆ OpenGL Programming Guide (the “red book” – available online):
 - First four sections of chapter 2
 - First section of chapter 6
- ◆ Foley et al., sections 1.5, 4.2-4.5
- ◆ I.E. Sutherland. Sketchpad: a man-machine graphics communication system. *Proceedings of the Spring Joint Computer Conference*, p. 329-346, 1963.
- ◆ T.H. Myer & I.E. Sutherland. On the design of display processors. *Communications of the ACM* 11(6): 410-414, 1968.

Modern graphics systems

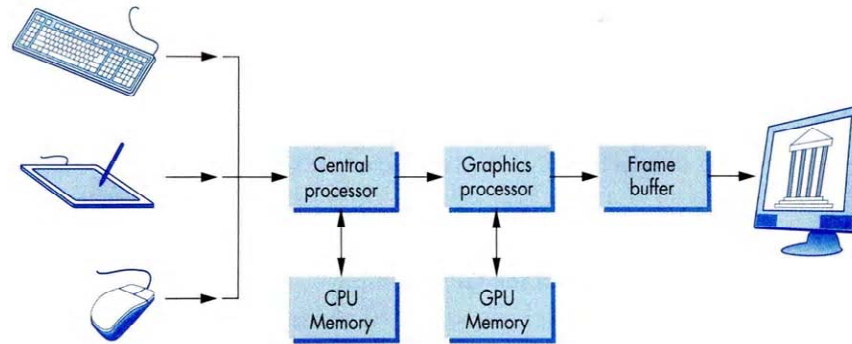

[Angel, 2012]

Current graphics systems consist of:

- An application, which talks to a...
- Graphics library (e.g., OpenGL or Direct3D), which talks to the...
- Graphics hardware

The graphics hardware can do a lot of fancy work these days. We'll take a brief tour, starting from the display...

Light as an EM wave

We can model light as an electromagnetic wave:

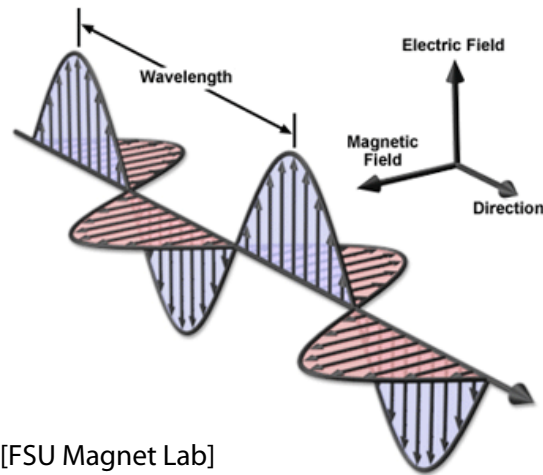

The E and M fields are tightly coupled, so we usually just talk about the E field.

The orientation of the E field is the polarization. The example above is monochromatic (one wavelength) and linearly polarized (E field oscillates in a line, up and down in this case).

Light as an EM wave (cont'd)

Polychromatic, linearly polarized:

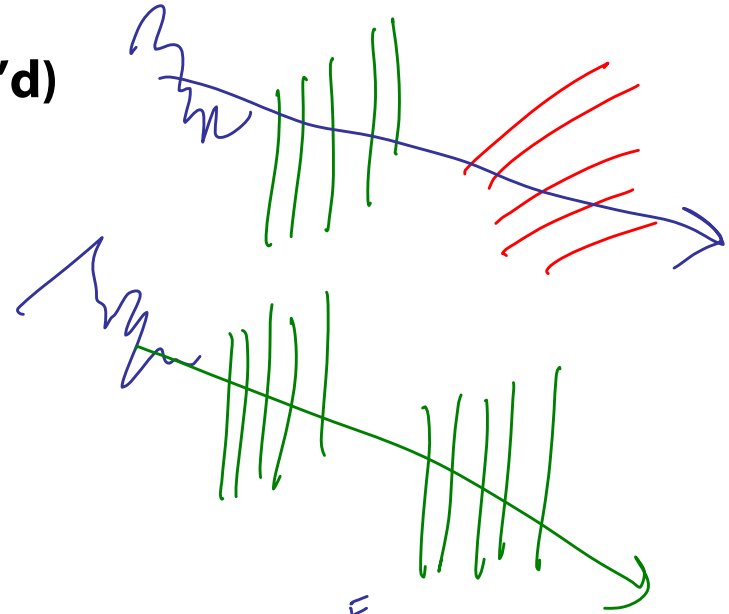
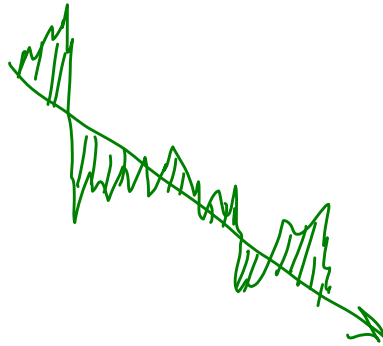

Polychromatic, unpolarized:

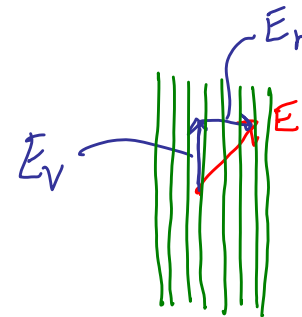
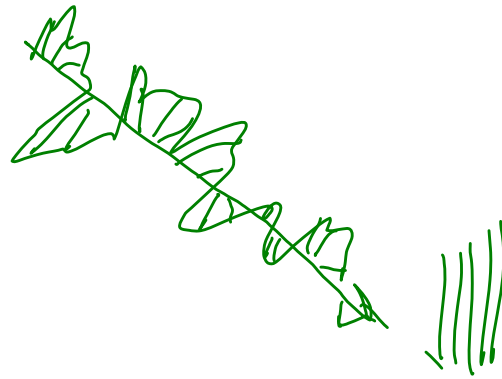

A linear polarizer is a filter that extracts the vector component of the light wave along a particular direction.

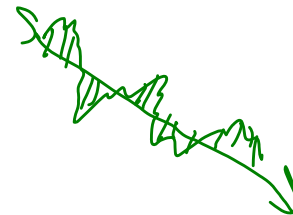

Liquid Crystal Display

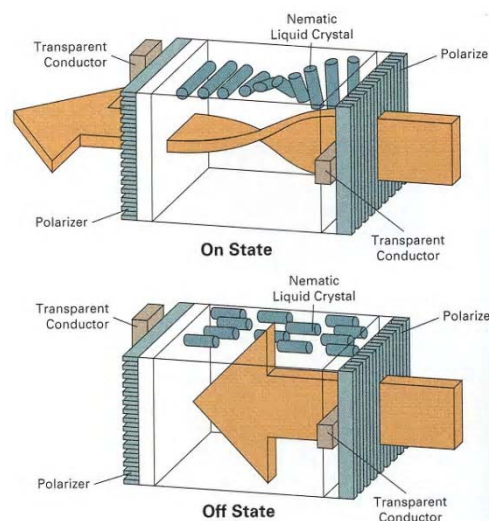

[Hearn and Baker, 2004]

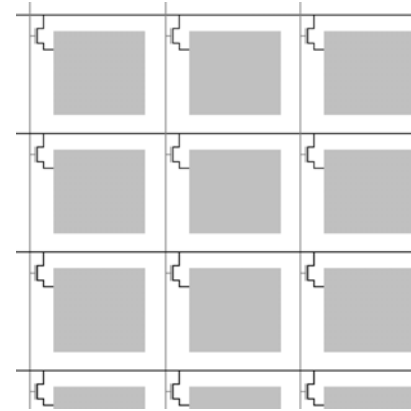

[Wikipedia]

Laptops typically use **liquid crystal displays (LCD's)**.

- ◆ Light enters a **vertical polarizer**
- ◆ **Nematic crystal** twists light based on applied voltage (more voltage, less twisting)
- ◆ Light passes through **horizontal polarizer**

Thin Film Transistors (TFTs), addressed by row and column, are used to hold a voltage at each cell.

There are variations on this design, but the polarization-rotating crystal always a key element.

Additive color mixing

All colors on a display are produced using combinations of red, green, and blue.

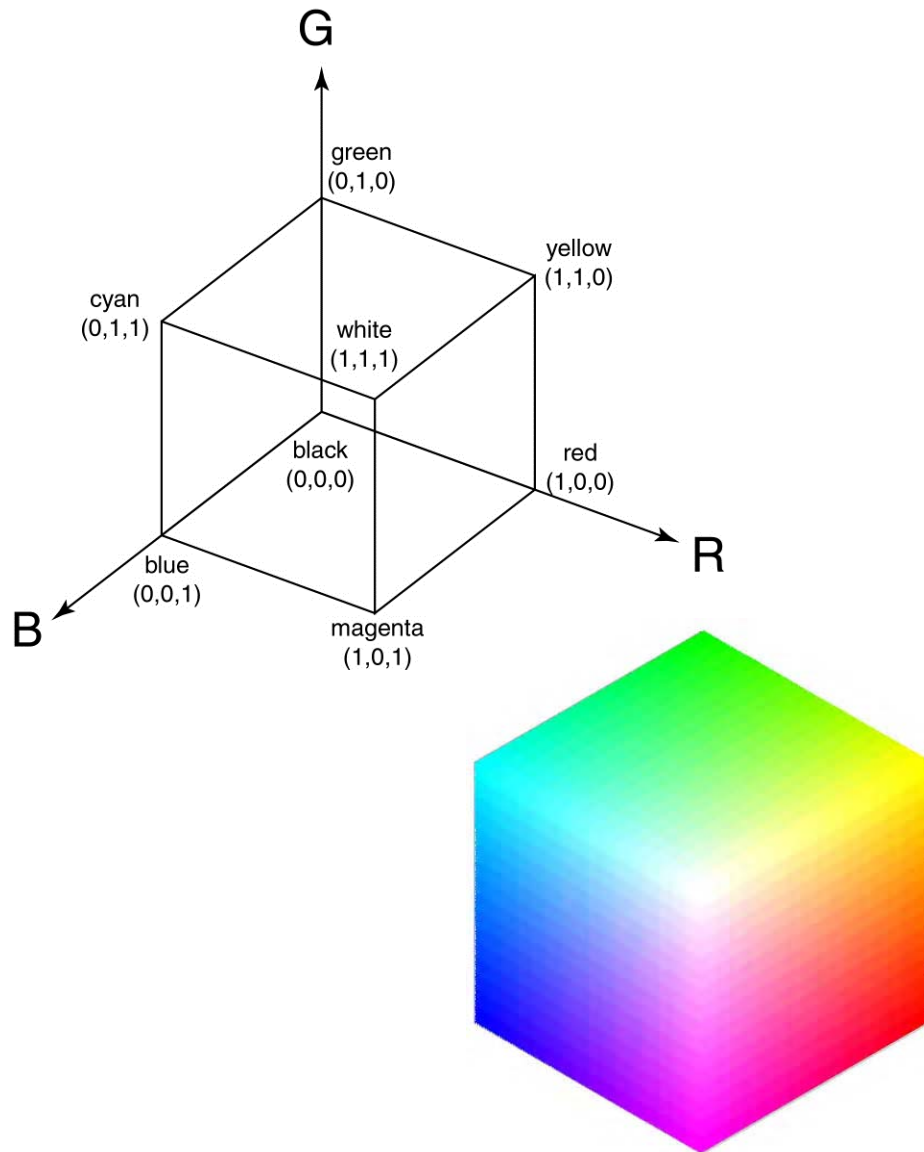

Anatomy of an RGB image

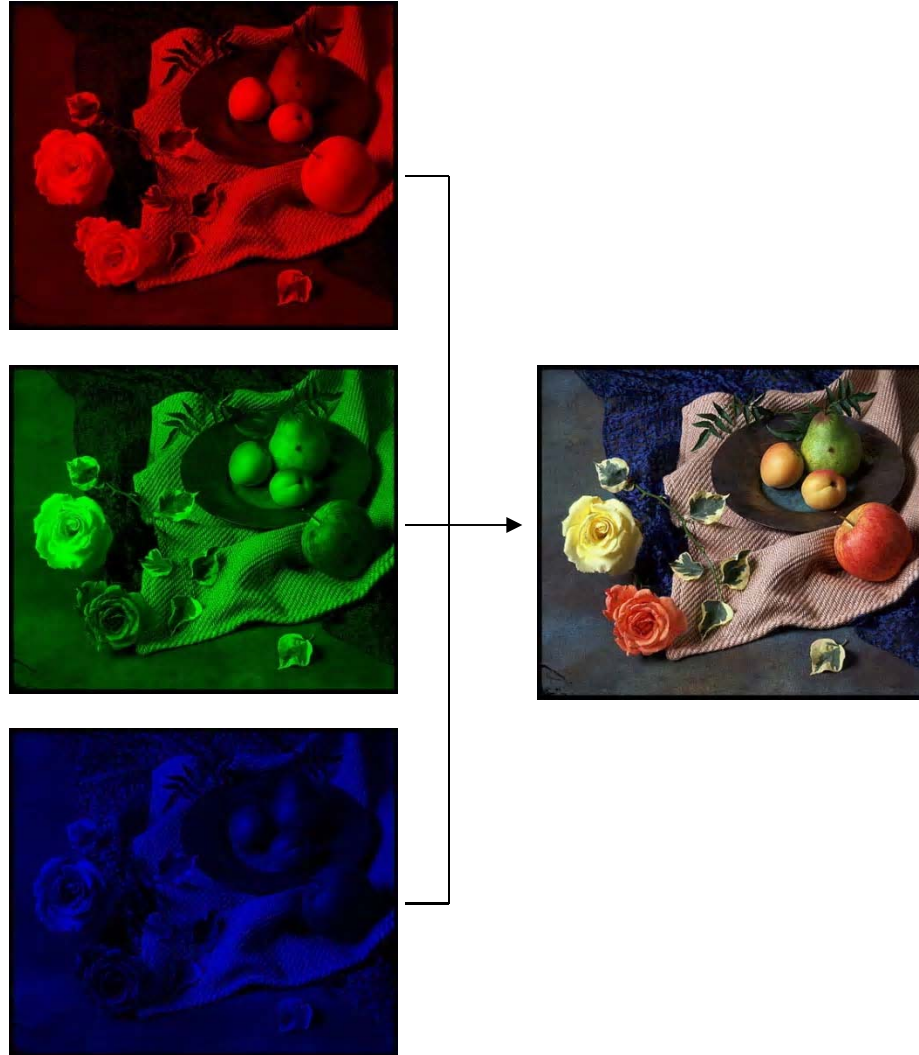

LCD Color

Color is obtained using color filters:

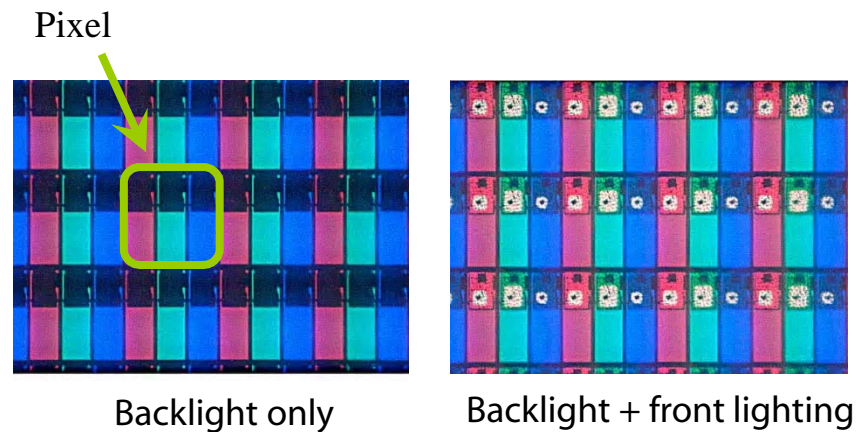

[Wikipedia]

Pixel is one region on the display corresponding to one color sample of an image being shown.

Our eyes average the closely spaced RGB colors spatially to create the impression of a composite color at each pixel.

LCD Backlights

Backlighting can be fluorescent or LED:



The lighting is arranged into a column or a sparse array and then diffused evenly:

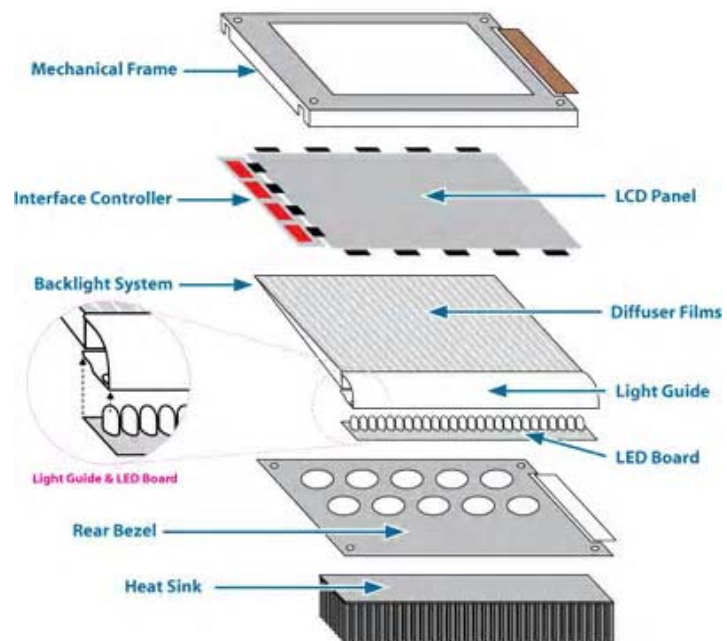

OLEDs

Organic Light Emitting Diodes are a competing technology now found in many mobile devices.

Idea:

- ◆ layer of organic molecules is sandwiched between two electrodes.
- ◆ Excitons release their energy in the form of light.
- ◆ Electrons and holes are injected into the organic layer, forming “excitons” (energetic, neutral quasiparticles).

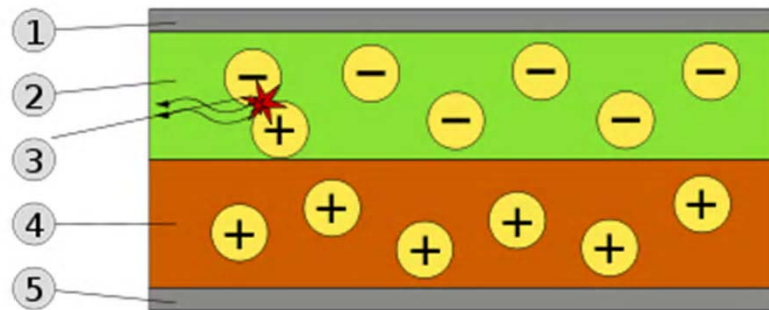

Schematic of a bilayer OLED: 1. Cathode (-), 2. Emissive Layer, 3. Emission of radiation, 4. Conductive Layer, 5. Anode (+). [Wikipedia]

OLEDs (cont'd)

Several pros vs. LCDs:

- ◆ Easy to make front and back sides transparent, good for augmented reality (e.g., Google Glass)
- ◆ Can be deposited onto flexible material
- ◆ Power is consumed to create light as needed, not to “throw it away”.
- ◆ Avoid color filters by choosing different polymers → more power savings.

Several cons vs. LCDs:

- ◆ Power needed for bright light can be substantially greater than LCD. E.g., OLED consumes more power than LCD for black text on white background.
- ◆ The organic molecules decay over time, shorter lifespan than LCD.
- ◆ The decay of molecules is different based on color → color balance changes over time.

Electrophoretic Ink Displays

Most non-LCD/OLED electronic readers use **electrophoretic ink**. One of the biggest manufacturers is E Ink.

The idea is to embed charged white balls and oppositely charged black balls inside of tiny capsules. Applied voltages control how many white vs. black balls float to the viewing surface.

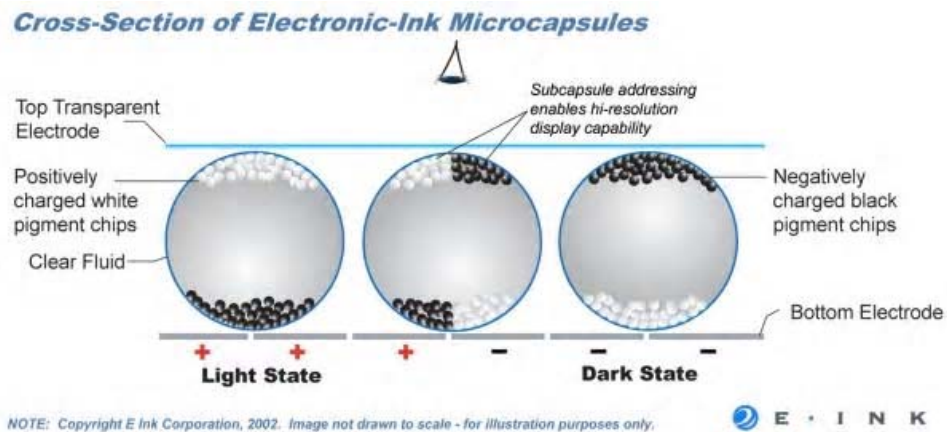

This kind of display is **bistable**, which means that the image holds after removing the voltage.

A front light can be added for night reading.

RGB framebuffer

The brightness of each LCD element is controlled by a dedicated memory array called a **framebuffer**.

Each element of the framebuffer is associated with a single **pixel** on the screen.

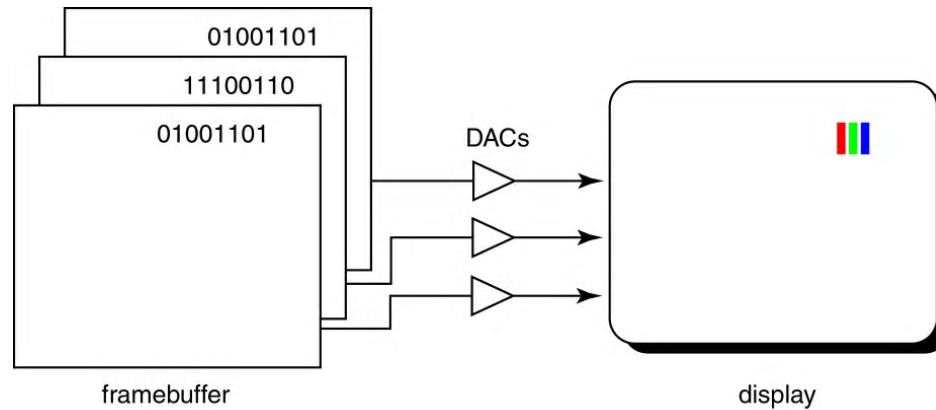

Typically, a display allows 256 voltage settings for each of R, G, and B.

We sometimes call each R, G, or B component a **channel** (so the “red channel” of an image is only the R component per pixel.).

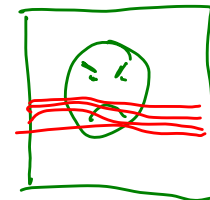
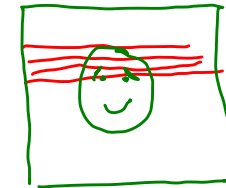
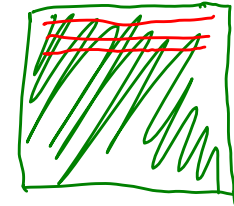

Double-buffering

Q: What happens when you write to the framebuffer while it is being displayed on the monitor?

Double-buffering provides a solution.

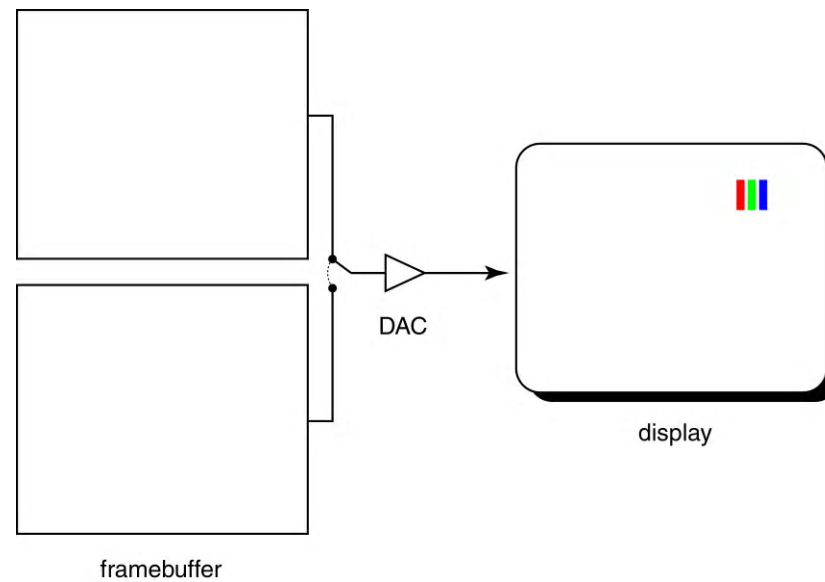

OpenGL

The API we'll be using for drawing to the framebuffer is OpenGL.

For 2D graphics, OpenGL lets you specify colors of primitives and then draw them to the screen. Typical primitives include:

- ◆ Points
- ◆ Lines
- ◆ Unfilled polygons
- ◆ Filled polygons

You just name a color, declare the primitive type, and specify the vertices, and OpenGL does the rest.

OpenGL also supports "alpha" blending. A typical operation is a linear mixture that blends a new color into the framebuffer:

$$F_{new} = \alpha C + (1 - \alpha) F_{old}$$