

Specific Object Recognition: Matching in 2D

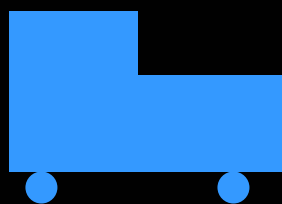

engine model

Is there an engine in the image?
If so, where is it located?

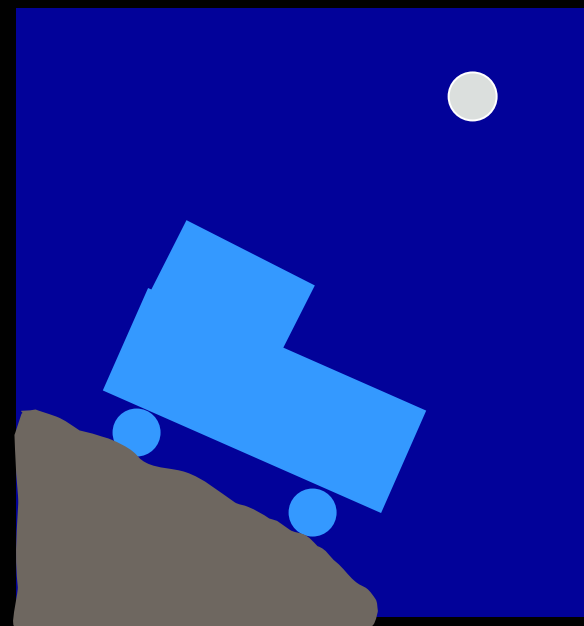
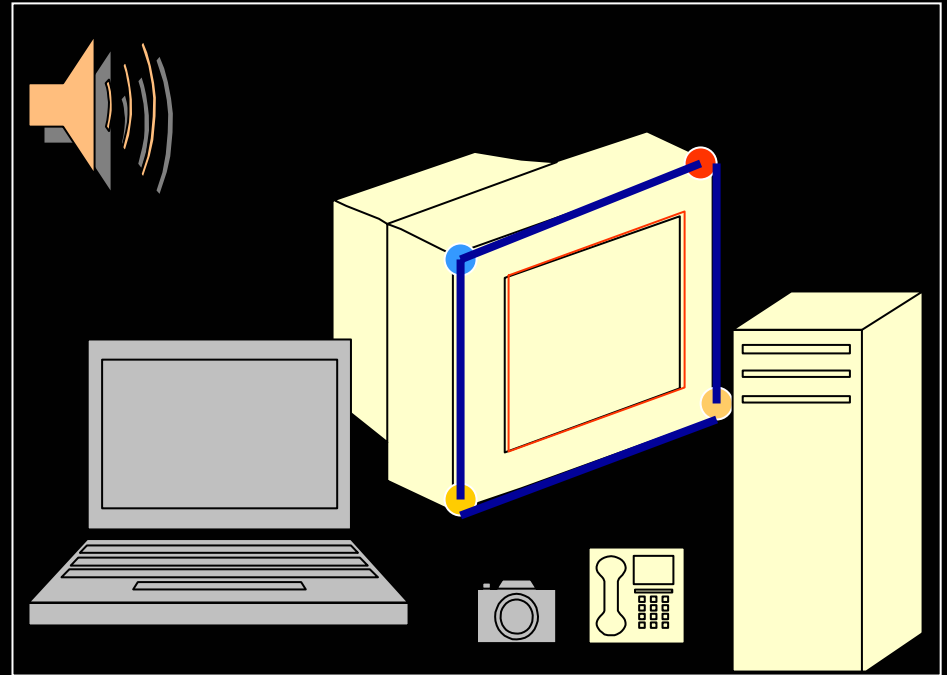
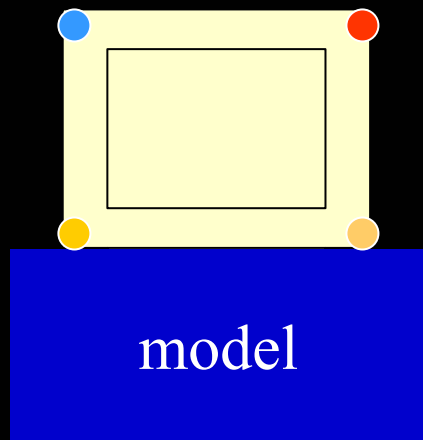

image containing an
instance of the model

Alignment

- Use a geometric feature-based model of the object.
- Match features of the object to features in the image.
- Produce a hypothesis h (matching features)
- Compute an affine transformation T from h
- Apply T to the features of the model to map the model features to the image.
- Use a verification procedure to decide how well the model features line up with actual image features

Alignment



image

How can the object in the image differ from that in the model?

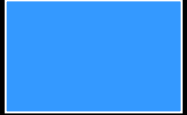

Most often used:

2D Affine Transformations

1. translation

2. rotation

3. scale

4. skew

$$\begin{bmatrix} u \\ v \end{bmatrix} = \begin{bmatrix} a & b \\ c & d \end{bmatrix} \begin{bmatrix} x \\ y \end{bmatrix}$$

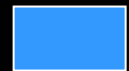
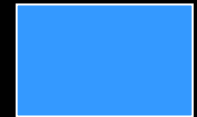
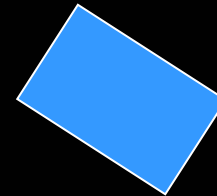

Point Representation and Transformations

Normal Coordinates for a 2D Point

$$P = [x, y]^t = \begin{bmatrix} x \\ y \end{bmatrix}$$

Homogeneous Coordinates

$$P = [sx, sy, s]^t \quad \text{where } s \text{ is a scale factor}$$

Scaling

$$\begin{bmatrix} x' \\ y' \end{bmatrix} = \begin{bmatrix} c_x & 0 \\ 0 & c_y \end{bmatrix} \begin{bmatrix} x \\ y \end{bmatrix} = \begin{bmatrix} c_x * x \\ c_y * y \end{bmatrix}$$

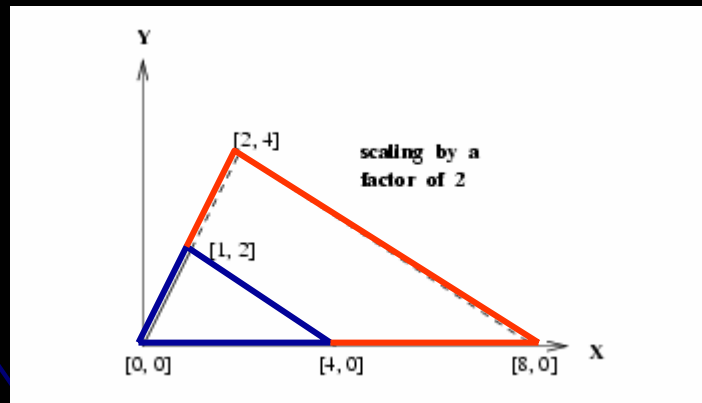

scaling by
a factor of 2
about (0,0)

Rotation

$$\begin{bmatrix} x' \\ y' \end{bmatrix} = \begin{bmatrix} \cos \theta & -\sin \theta \\ \sin \theta & \cos \theta \end{bmatrix} \begin{bmatrix} x \\ y \end{bmatrix} = \begin{bmatrix} x \cos \theta - y \sin \theta \\ x \sin \theta + y \cos \theta \end{bmatrix}$$

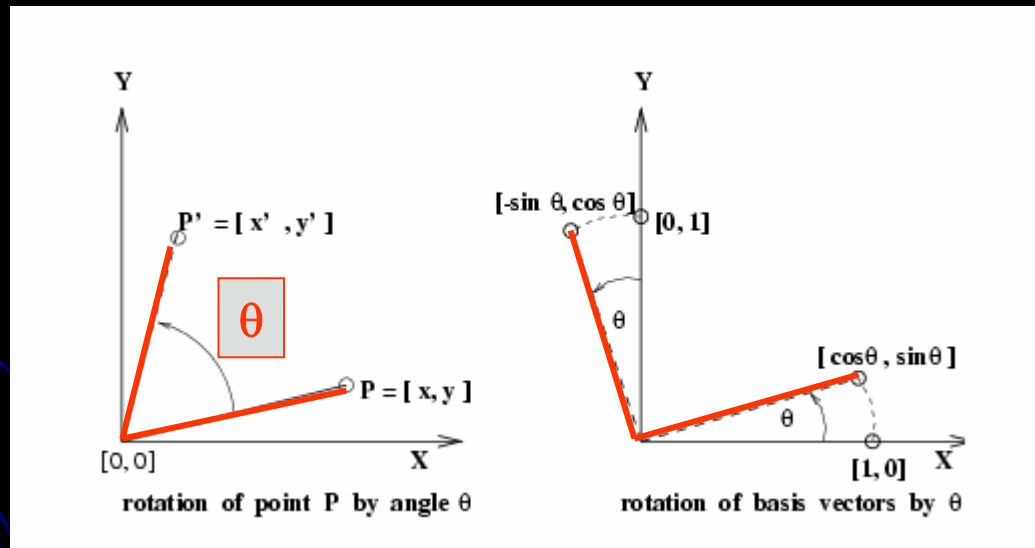

rotate point

rotate axes

Translation

2 X 2 matrix doesn't work for translation!
Here's where we need homogeneous coordinates.

$$\begin{pmatrix} x' \\ y' \\ 1 \end{pmatrix} = \begin{pmatrix} 1 & 0 & x_0 \\ 0 & 1 & y_0 \\ 0 & 0 & 1 \end{pmatrix} \begin{pmatrix} x \\ y \\ 1 \end{pmatrix} = \begin{pmatrix} x + x_0 \\ y + y_0 \\ 1 \end{pmatrix}$$

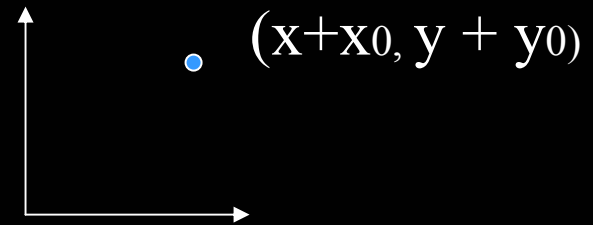
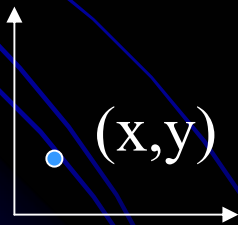

Rotation, Scaling and Translation

$$\begin{pmatrix} x_w \\ y_w \\ 1 \end{pmatrix} = \begin{pmatrix} 1 & 0 & x_0 \\ 0 & 1 & y_0 \\ 0 & 0 & 1 \end{pmatrix} \begin{pmatrix} s & 0 & 0 \\ 0 & s & 0 \\ 0 & 0 & 1 \end{pmatrix} \begin{pmatrix} \cos \theta & -\sin \theta & 0 \\ \sin \theta & \cos \theta & 0 \\ 0 & 0 & 1 \end{pmatrix} \begin{pmatrix} x_i \\ y_i \\ 1 \end{pmatrix}$$

T S R



T_R

2D Model and 3 Matching Images of a Boeing Airplane Part

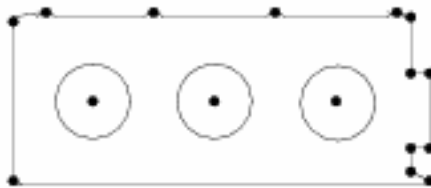

a) Part Model

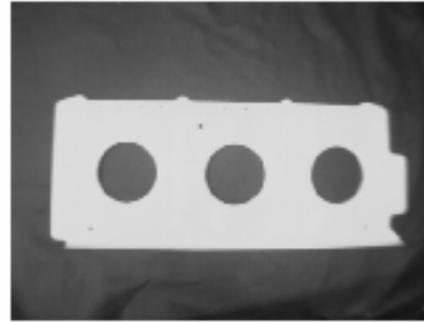

b) Horizontal Image

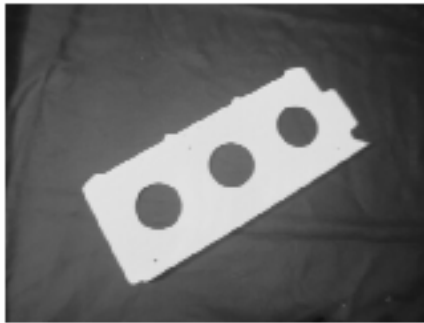

c) Rotated Image

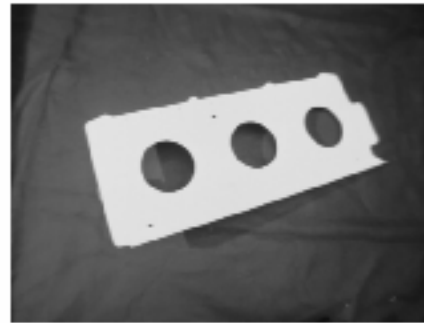

d) Rotated and Skewed Image

Computing Affine Transformations between Sets of Matching Points

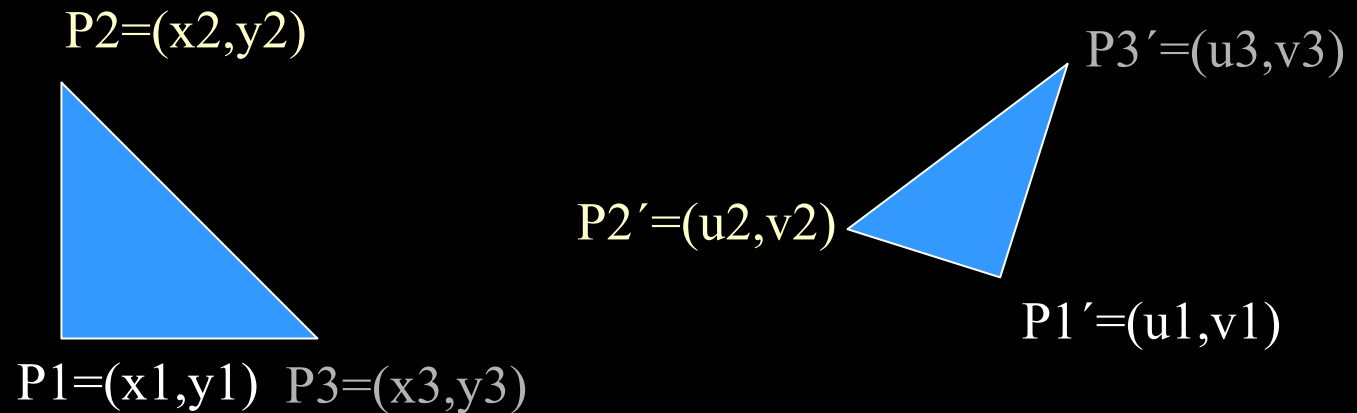

Given 3 matching pairs of points, the affine transformation can be computed through solving a simple matrix equation.

$$\begin{bmatrix} u1 & u2 & u3 \\ v1 & v2 & v3 \\ 1 & 1 & 1 \end{bmatrix} = \begin{bmatrix} a11 & a12 & a13 \\ a21 & a22 & a23 \\ 0 & 0 & 1 \end{bmatrix} \begin{bmatrix} x1 & x2 & x3 \\ y1 & y2 & y3 \\ 1 & 1 & 1 \end{bmatrix}$$

A More Robust Approach

Using only 3 points is dangerous, because if even one is off, the transformation can be far from correct.

Instead, use many ($n = 10$ or more) pairs of matching control points to determine a **least squares estimate** of the six parameters of the affine transformation.

Error(a_{11} , a_{12} , a_{13} , a_{21} , a_{22} , a_{23}) =

$$\sum_{j=1, n} \left((a_{11} * x_j + a_{12} * y_j + a_{13} - u_j)^2 + (a_{21} * x_j + a_{22} * y_j + a_{23} - v_j)^2 \right)$$

The Equations to Solve

$$\varepsilon(a_{11}, a_{12}, a_{13}, a_{21}, a_{22}, a_{23}) = \sum_{j=1}^n ((a_{11}x_j + a_{12}y_j + a_{13} - u_j)^2 + (a_{21}x_j + a_{22}y_j + a_{23} - v_j)^2) \quad (11.16)$$

Taking the six partial derivatives of the error function with respect to each of the six variables and setting this expression to zero gives us the six equations represented in matrix form in Equation 11.17 .

$$\begin{bmatrix} \Sigma x_j^2 & \Sigma x_j y_j & \Sigma x_j & 0 & 0 & 0 \\ \Sigma x_j y_j & \Sigma y_j^2 & \Sigma y_j & 0 & 0 & 0 \\ \Sigma x_j & \Sigma y_j & \Sigma 1 & 0 & 0 & 0 \\ 0 & 0 & 0 & \Sigma x_j^2 & \Sigma x_j y_j & \Sigma x_j \\ 0 & 0 & 0 & \Sigma x_j y_j & \Sigma y_j^2 & \Sigma y_j \\ 0 & 0 & 0 & \Sigma x_j & \Sigma y_j & \Sigma 1 \end{bmatrix} \begin{bmatrix} a_{11} \\ a_{12} \\ a_{13} \\ a_{21} \\ a_{22} \\ a_{23} \end{bmatrix} = \begin{bmatrix} \Sigma u_j x_j \\ \Sigma u_j y_j \\ \Sigma u_j \\ \Sigma v_j x_j \\ \Sigma v_j y_j \\ \Sigma v_j \end{bmatrix} \quad (11.17)$$

What is this for?

Many 2D matching techniques use it.

1. Local-Feature Focus Method

2. Pose Clustering

3. Geometric Hashing

Local-Feature-Focus Method

- Each model has a set of features (interesting points).
 - The focus features are the particularly detectable features, usually representing several different areas of the model.
 - Each focus feature has a set of nearby features that can be used, along with the focus feature, to compute the transformation.

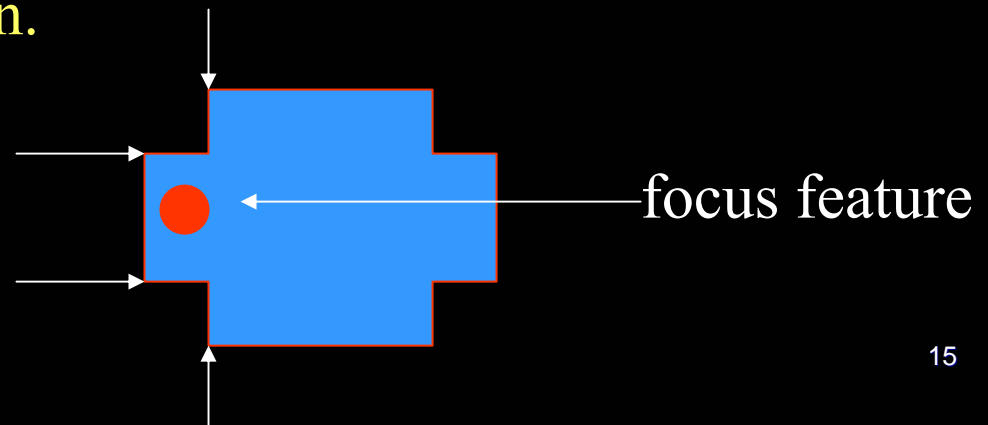

LFF Algorithm

Let G be the set of detected image features.

Let F_m be focus features of the model.

Let $S(f)$ be the nearby features for feature f .

for each focus feature F_m

for each image feature G_i of the same type as F_m

1. find the maximal subgraph S_m of $S(F_m)$ that matches a subgraph S_i of $S(G_i)$.
2. Compute transformation T that maps the points of each feature of S_m to the corresponding one of S_i .
3. Apply T to the line segments of the model.
4. If enough transformed segments find evidence in the image, return(T)

Example Match 1: Good Match

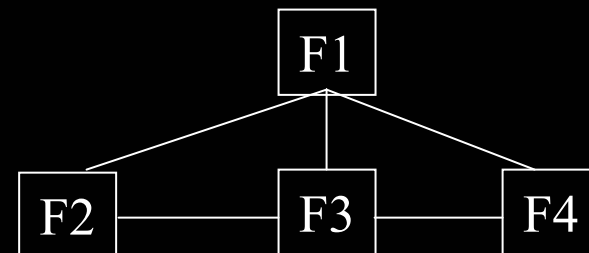
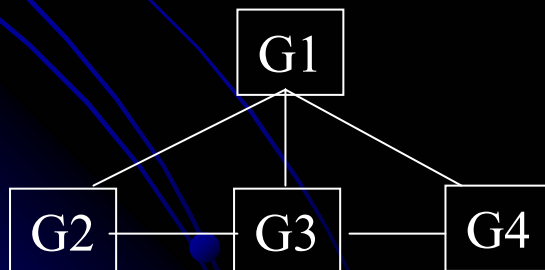
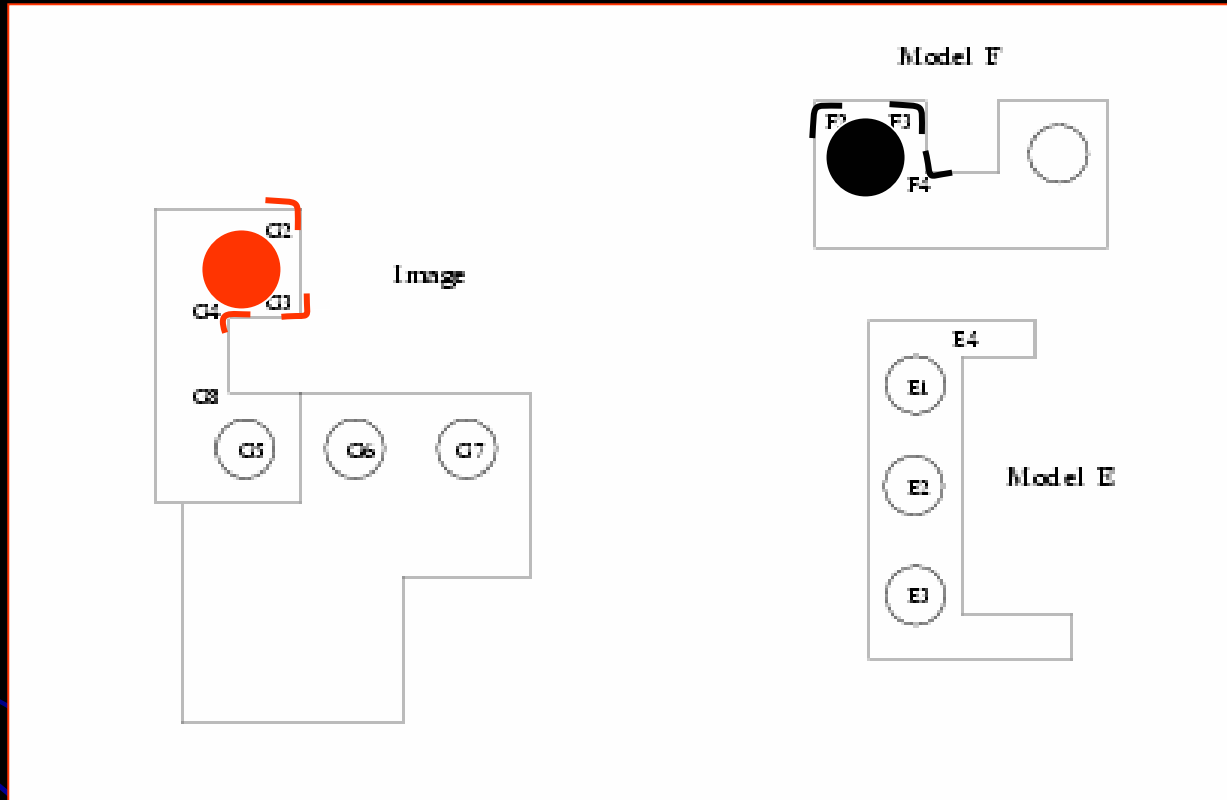

Example Match 2: Poor Match

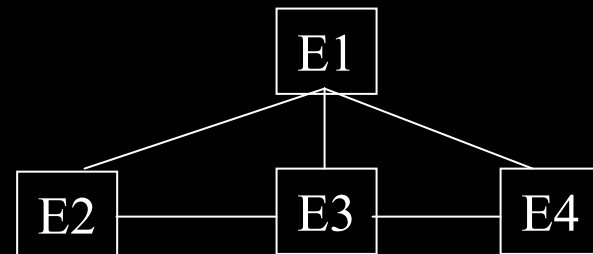
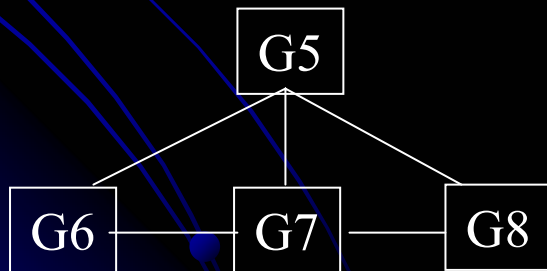
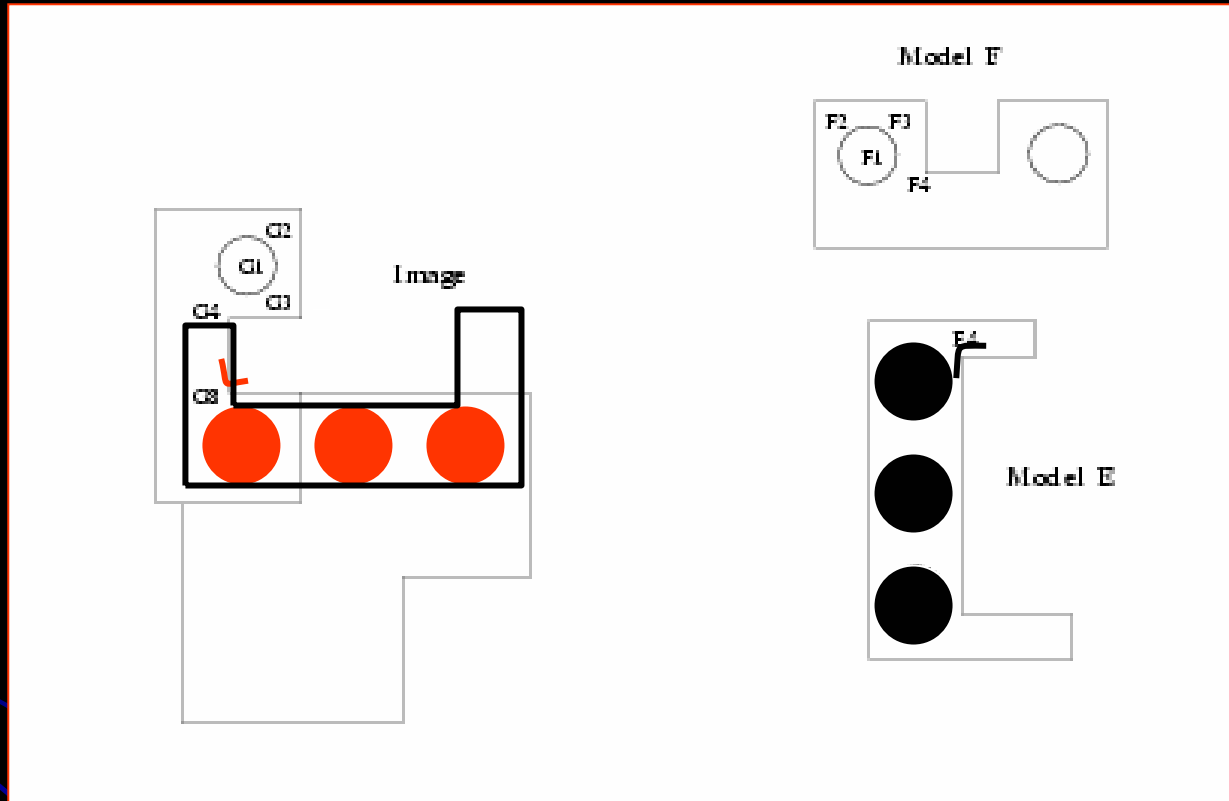

Pose Clustering

Let T be a transformation aligning model M with image object O .

The **pose** of object O is its location and orientation, **defined by T** .

The idea of pose clustering is to **compute lots of possible pose transformations**, each based on 2 points from the model and 2 hypothesized corresponding points from the image.*

Then **cluster all the transformations** in pose space and try to **verify** the large clusters.

* This is not a full affine transformation, just RST.

Pose Clustering

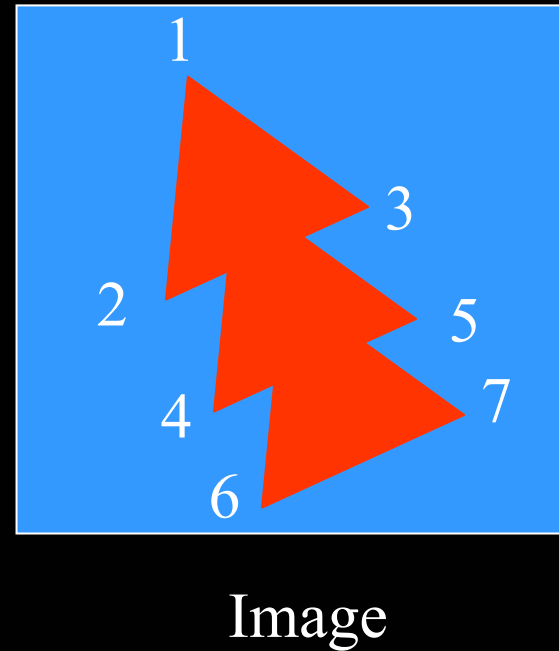
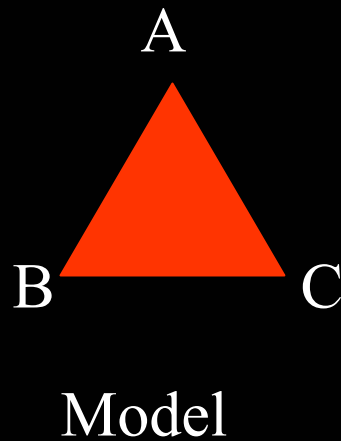

Correct Match: mapping = $\{ (1,A), (2,B), (3,C) \}$

There will be some votes for $(B,C) \rightarrow (4,5)$, $(B,C) \rightarrow (6,7)$ etc.

Pose Clustering Applied to Detecting a Particular Airplane

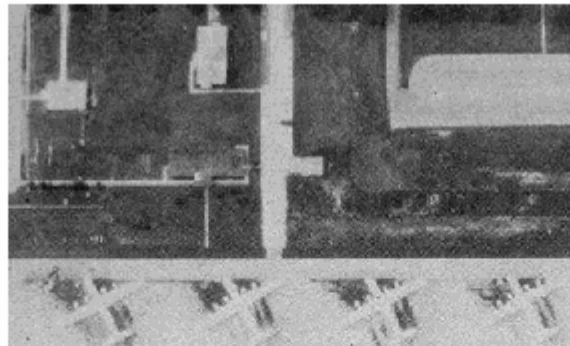

(a) original airfield image

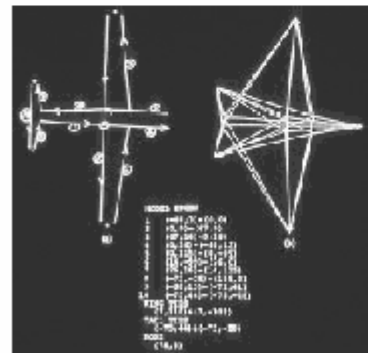

(b) model of object

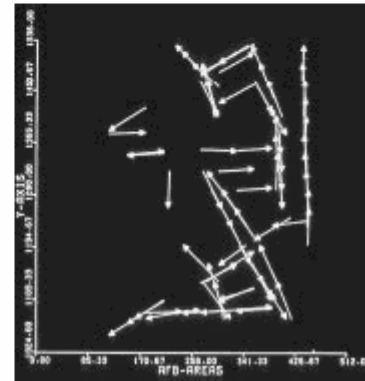

(c) detections matching model

Geometric Hashing

- This method was developed for the case where there is a **whole database of models** to try to find in an image.

- It trades:

a large amount of offline preprocessing and
a large amount of space

- for potentially **fast online**

object recognition
pose detection

Theory Behind Geometric Hashing

- A **model M** is a an ordered set of feature points.

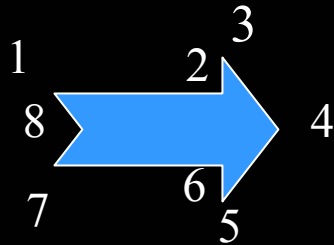

$$M = \langle P_1, P_2, P_3, P_4, P_5, P_6, P_7, P_8 \rangle$$

- An **affine basis** is any subset $E = \{e_{00}, e_{01}, e_{10}\}$ of noncollinear points of **M**.
- For basis E , any point $x \in M$ can be represented in **affine coordinates** (ξ, η) .

$$x = \xi(e_{10} - e_{00}) + \eta(e_{01} - e_{00}) + e_{00}$$

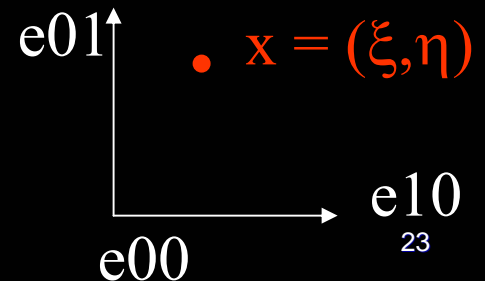

Affine Transform

If x is represented in affine coordinates (ξ, η) .

$$\mathbf{x} = \xi(\mathbf{e}_{10} - \mathbf{e}_{00}) + \eta(\mathbf{e}_{01} - \mathbf{e}_{00}) + \mathbf{e}_{00}$$

and we apply affine transform T to point x , we get

$$T\mathbf{x} = \xi(T\mathbf{e}_{10} - T\mathbf{e}_{00}) + \eta(T\mathbf{e}_{01} - T\mathbf{e}_{00}) + T\mathbf{e}_{00}$$

In both cases, x has the same coordinates (ξ, η) .

Example

original object

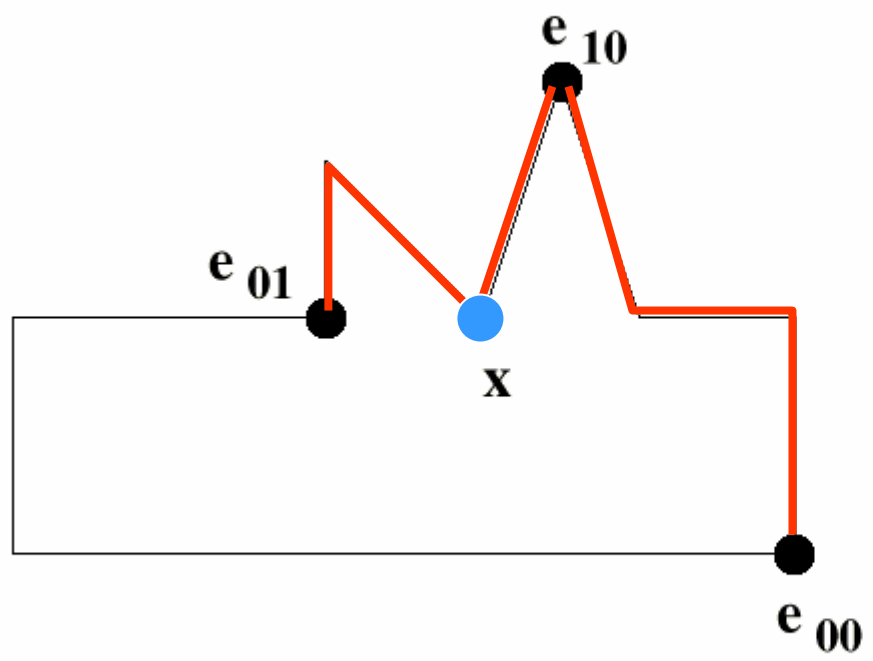

transformed object

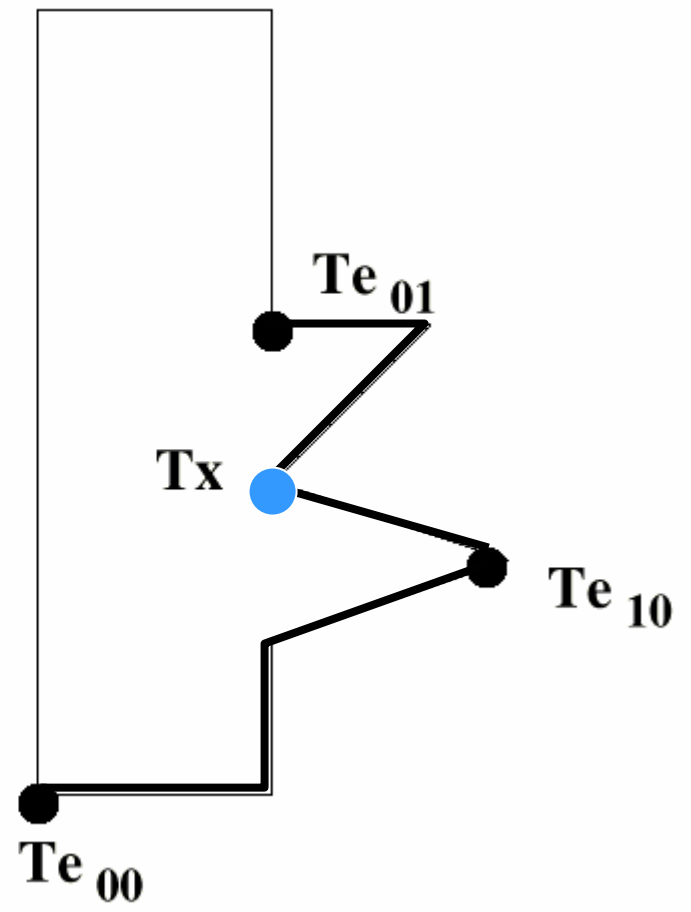

Offline Preprocessing

For each model M

{

Extract feature point set FM

for each noncollinear triple E of FM (**basis**)

for each **other point** x of FM

{

calculate (ξ, η) for x with respect to E

store (M, E) in hash table H at index (ξ, η)

}

}

Hash Table

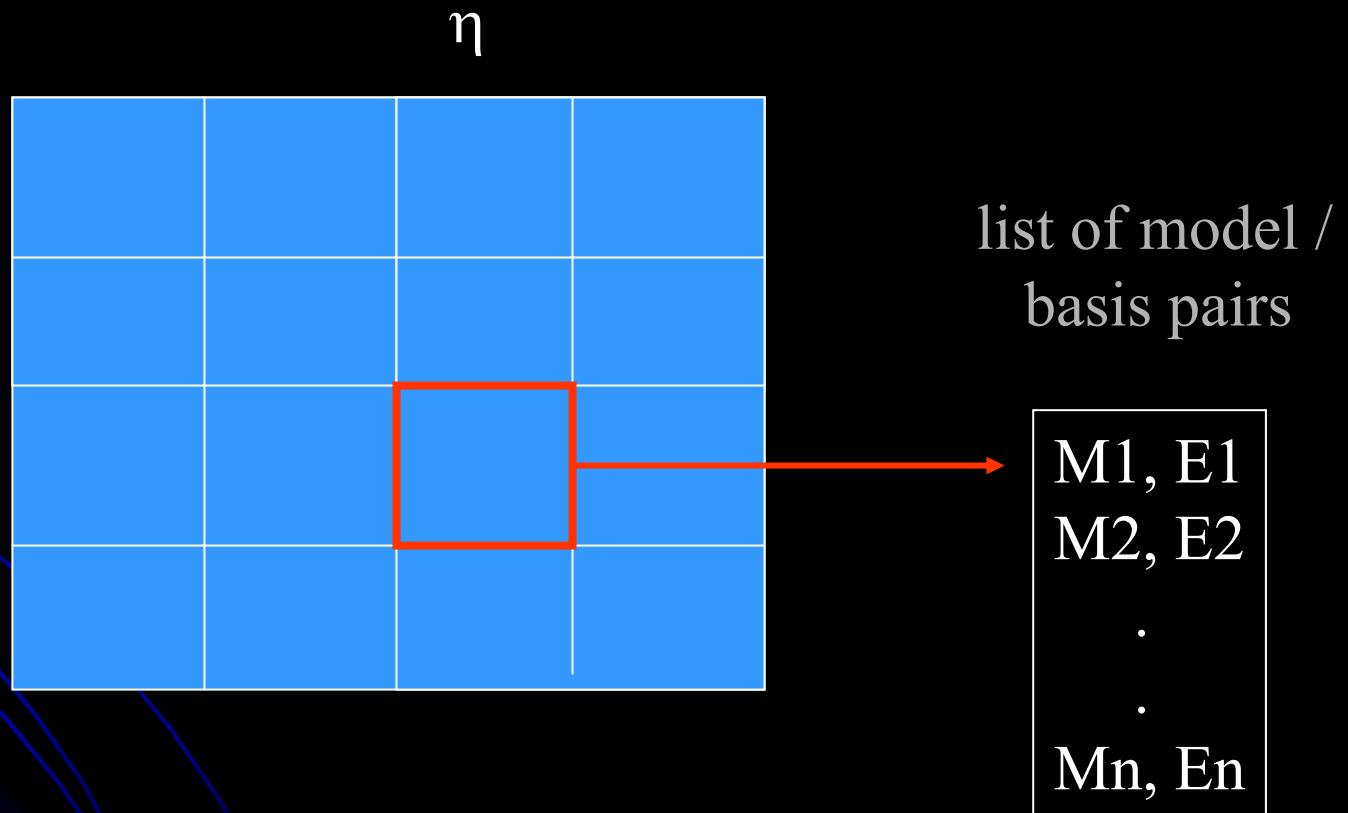

Online Recognition

initialize accumulator A to all zero
extract feature points from image
for each basis triple **F** /* one basis */
 for each other point **v** /* each image point */
 {
 calculate (ξ, η) for **v** with respect to **F**
 retrieve list L from hash table at index (ξ, η)
 for each pair (M,E) of L
 $A[M,E] = A[M,E] + 1$
 }
find peaks in accumulator array A
for each peak (M,E) in A
 calculate and try to **verify** $T \ni: F = TE$

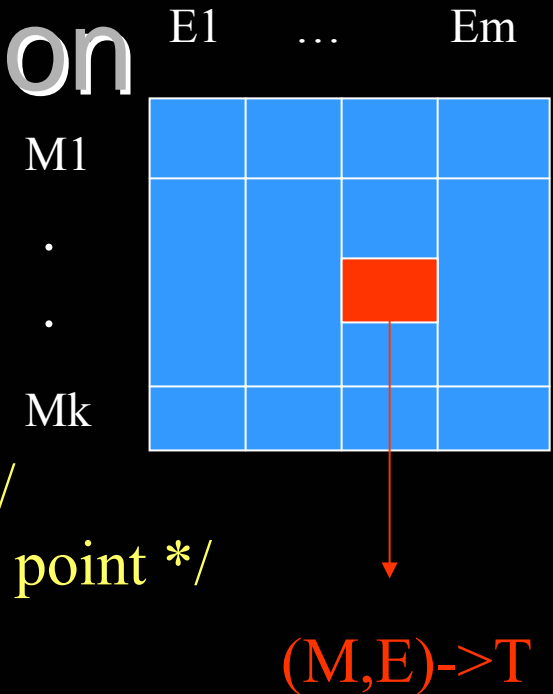

Verification

How well does the transformed model line up with the image.

- compare positions of feature points
- compare full line or curve segments

Whole segments work better, allow less **halucination**, but there's a higher cost in execution time.

2D Matching Mechanisms

- We can formalize the recognition problem as finding a mapping from model structures to image structures.
- Then we can look at different paradigms for solving it.
 - interpretation tree search
 - discrete relaxation
 - relational distance
 - continuous relaxation

Formalism

- A **part** (unit) is a structure in the scene, such as a region or segment or corner.
- A **label** is a symbol assigned to identify the part.
- An **N-ary relation** is a set of N-tuples defined over a set of parts or a set of labels.
- An **assignment** is a mapping from parts to labels.

Example

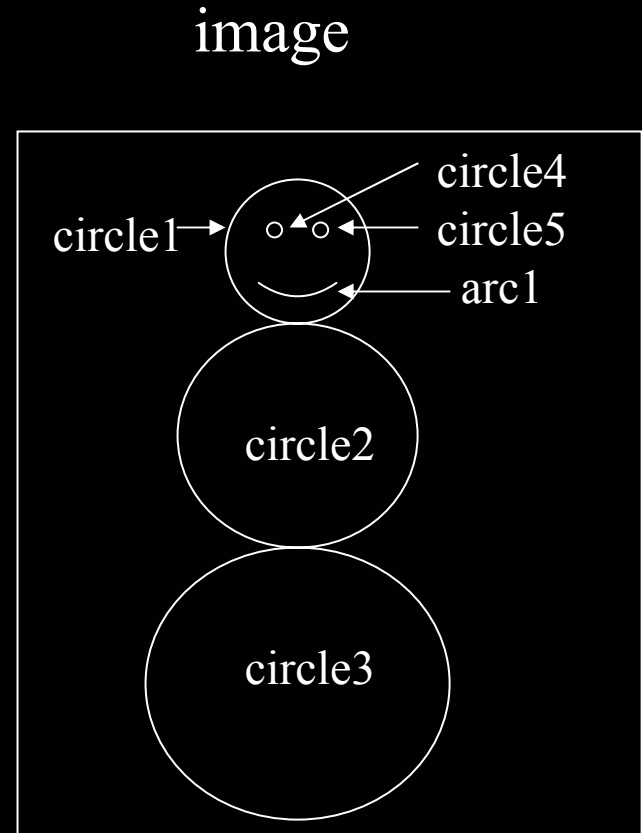
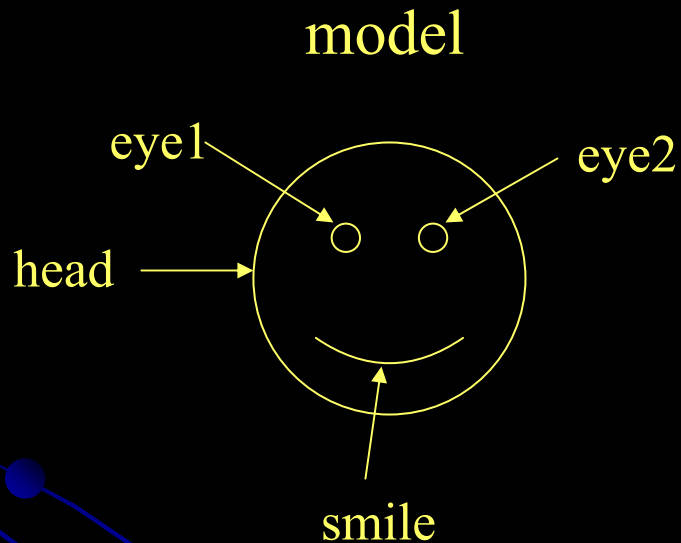

What are the relationships?

What is the best assignment of model labels to image features?

Consistent Labeling Definition

Given:

1. a set of units **P**
2. a set of labels for those units **L**
3. a relation **RP** over set P
4. a relation **RL** over set L

A consistent labeling f is a mapping $f: P \rightarrow L$ satisfying

if $(p_i, p_j) \in RP$, then $(f(p_i), f(p_j)) \in RL$

which means that a consistent labeling preserves relationships.

Abstract Example

binary relation RL

binary relation RP

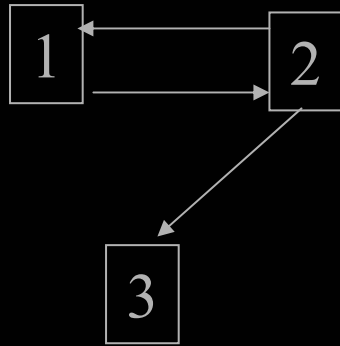

$$P = \{1, 2, 3\}$$

$$RP = \{(1, 2), (2, 1), (2, 3)\}$$

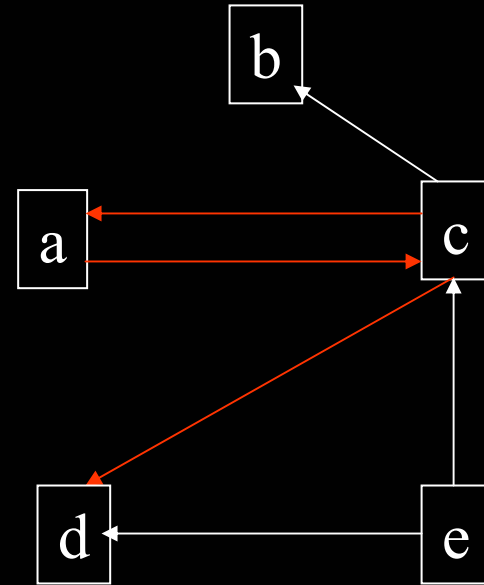

$$L = \{a, b, c, d, e\}$$

$$RL = \{(a, c), (c, a), (c, b), (c, d), (e, c), (e, d)\}$$

One consistent labeling is $\{(1, a), (2, c), (3, d)\}$

House Example

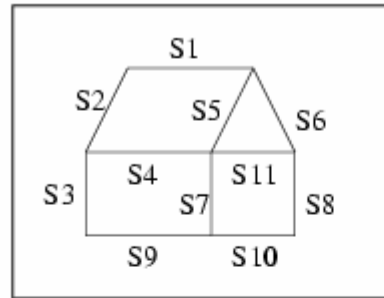

Image 1 **P**

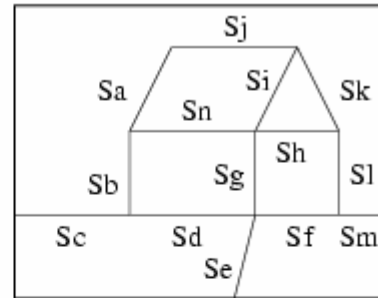

Image 2 **L**

$$P = \{S1, S2, S3, S4, S5, S6, S7, S8, S9, S10, S11\}.$$

$$L = \{Sa, Sb, Sc, Sd, Se, Sf, Sg, Sh, Si, Sj, Sk, Sl, Sm\}.$$

$$R_P = \{ (S1, S2), (S1, S5), (S1, S6), (S2, S3), (S2, S4), (S3, S4), (S3, S9), (S4, S5), (S4, S7), (S4, S11), (S5, S6), (S5, S7), (S5, S11), (S6, S8), (S6, S11), (S7, S9), (S7, S10), (S7, S11), (S8, S10), (S8, S11), (S9, S10) \}.$$

$$R_L = \{ (Sa, Sb), (Sa, Sj), (Sa, Sn), (Sb, Sc), (Sb, Sd), (Sb, Sn), (Sc, Sd), (Sd, Se), (Sd, Sf), (Sd, Sg), (Se, Sf), (Se, Sg), (Sf, Sg), (Sf, Sl), (Sf, Sm), (Sg, Sh), (Sg, Si), (Sg, Sn), (Sh, Si), (Sh, Sk), (Sh, Sl), (Sh, Sn), (Si, Sj), (Si, Sk), (Si, Sn), (Sj, Sk), (Sk, Sl), (Sl, Sm) \}.$$

RP and RL are connection relations.

$$f(S1) = Sj$$

$$f(S4) = Sn$$

$$f(S7) = Sg$$

$$f(S10) = Sf$$

$$f(S2) = Sa$$

$$f(S5) = Si$$

$$f(S8) = Sl$$

$$f(S11) = Sh$$

$$f(S3) = Sb$$

$$f(S6) = Sk$$

$$f(S9) = Sd$$

1. Interpretation Tree

- An **interpretation tree** is a tree that represents all assignments of labels to parts.
- Each path from the root node to a leaf represents a (partial) assignment of labels to parts.
- Every path terminates as either
 1. a complete consistent labeling
 2. a failed partial assignment

Interpretation Tree Example

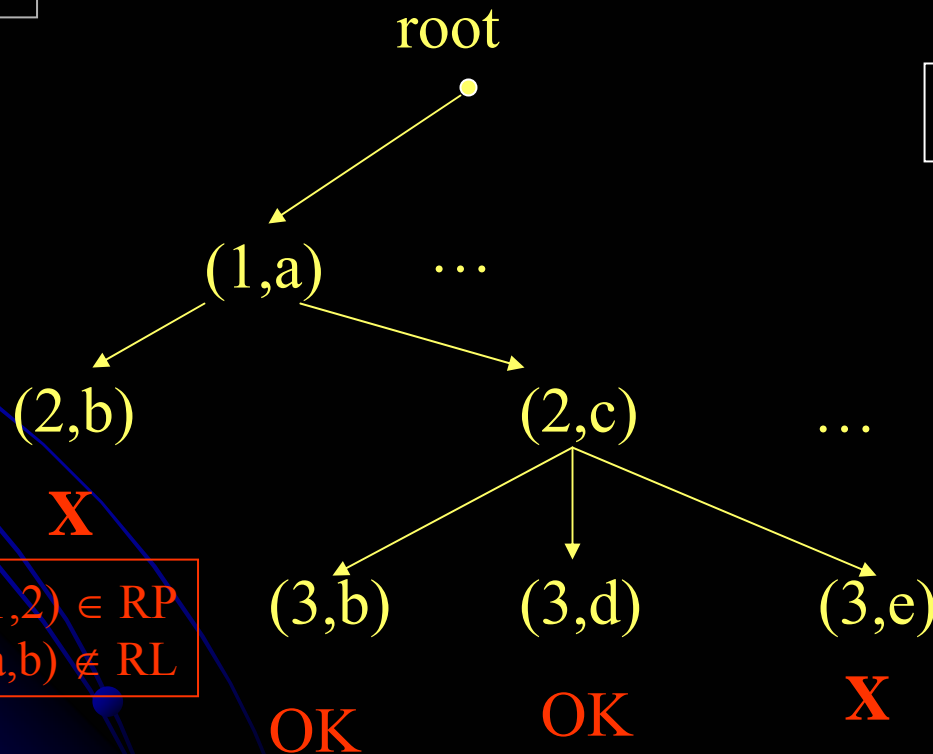
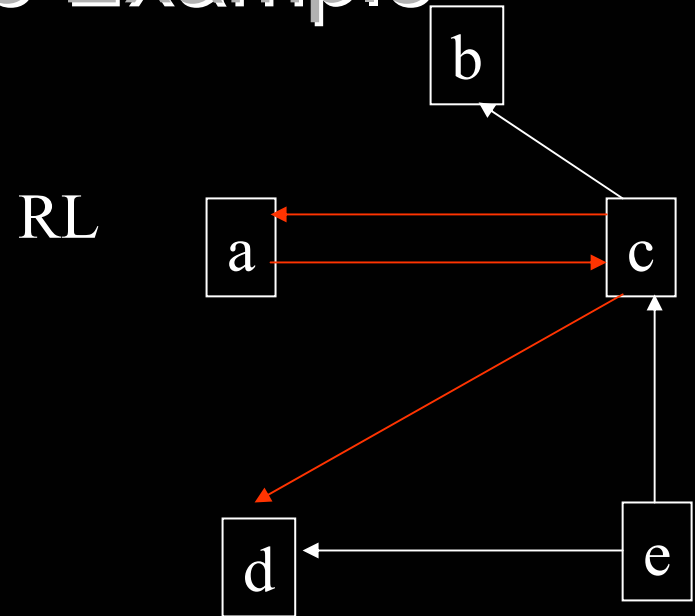
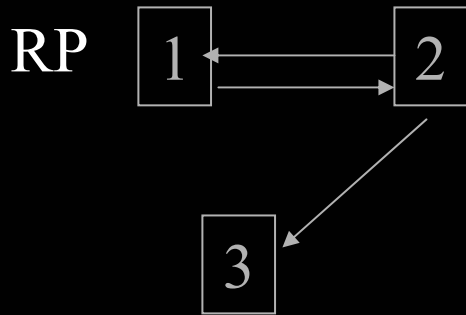

2. Discrete Relaxation

- Discrete relaxation is an alternative to (or addition to) the interpretation tree search.
- Relaxation is an iterative technique with polynomial time complexity.
- Relaxation uses local constraints at each iteration.
- It can be implemented on parallel machines.

How Discrete Relaxation Works

1. Each unit is assigned a set of **initial possible labels**.
2. All **relations are checked** to see if some pairs of labels are impossible for certain pairs of units.
3. **Inconsistent labels are removed** from the label sets.
4. If any labels have been filtered out then another pass is executed else the relaxation part is done.
5. If there is more than one labeling left, a tree search can be used to find each of them.

Example of Discrete Relaxation

RP

P_i

L1 L2 L3

X

P_j

L6 L8

RL

L1

L2

L3

L8

L6

There is no label in P_j's label set that is connected to L2 in P_i's label set. L2 is inconsistent and filtered out.

3. Relational Distance Matching

- A fully consistent labeling is unrealistic.
- An image may have missing and extra features; required relationships may not always hold.
- Instead of looking for a consistent labeling, we can look for the **best mapping from P to L**, the one that preserves the most relationships.

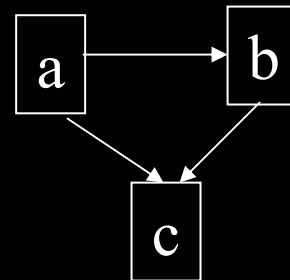
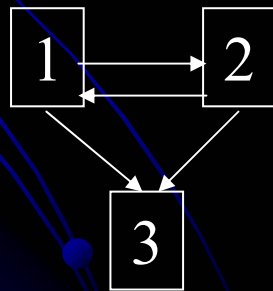

Preliminary Definitions

Def: A **relational description** DP is a sequence of relations over a set of primitives P.

- Let $DA = \{R_1, \dots, R_I\}$ be a relational description over A.
- Let $DB = \{S_1, \dots, S_I\}$ be a relational description over B.
- Let f be a 1-1, onto mapping from A to B.
- For any relation R, the composition $R \circ f$ is given by

$$R \circ f = \{(b_1, \dots, b_n) \mid (a_1, \dots, a_n) \text{ is in } R \text{ and } f(a_i) = (b_i), i=1, n\}$$

Example of Composition

$$R \circ f = \{(b_1, \dots, b_n) \mid (a_1, \dots, a_n) \text{ is in } R \text{ and } f(a_i) = (b_i), i=1, n\}$$

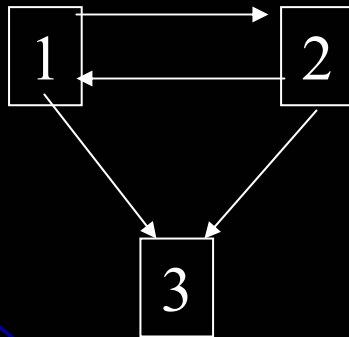

1	a
2	b
3	c

f

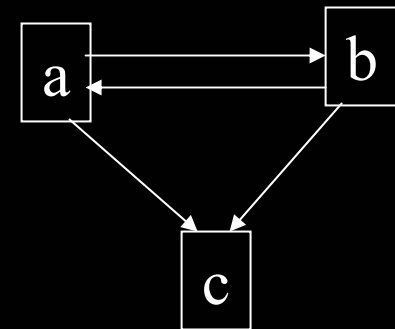

$R \circ f$

$R \circ f$ is an isomorphic copy of R with nodes renamed by f .

Relational Distance Definition

Let DA be a relational description over set A,
DB be a relational description over set B,
and $f : A \rightarrow B$.

- The **structural error of f** for R_i in DA and S_i in DB is

$$E_S^i(f) = |R_i \circ f - S_i| + |S_i \circ f^{-1} - R_i|$$

- The **total error of f** with respect to DA and DB is

$$E(f) = \sum_{i=1}^I E_S^i(f)$$

- The **relational distance** $GD(DA, DB)$ is given by

$$GD(DA, DB) = \min_{f : A \rightarrow B, f \text{ 1-1 and onto}} E(f)$$

Example

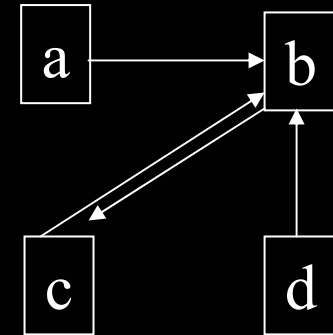
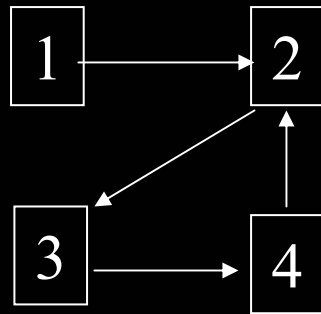

What is the best mapping?

What is the error of the best mapping?

Example

Let $f = \{(1,a), (2,b), (3,c), (4,d)\}$

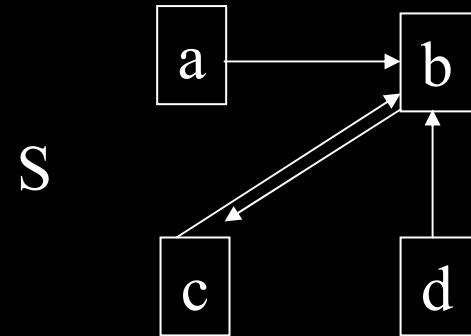
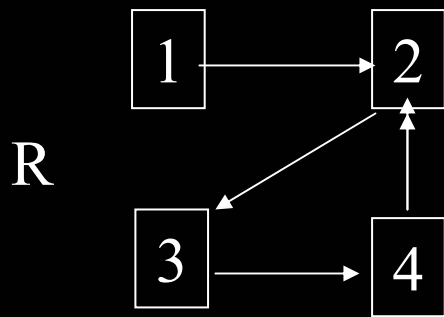

$$\begin{aligned} |R \circ f - S| &= |\{(a,b)(b,c)(c,d)(d,b)\} - \{(a,b)(b,c)(c,b)(d,b)\}| \\ &= |\{(c,d)\}| = 1 \end{aligned}$$

$$\begin{aligned} |S \circ f^{-1} - R| &= |\{(1,2)(2,3)(3,2)(4,2)\} - \{(1,2)(2,3)(3,4)(4,2)\}| \\ &= |\{(3,2)\}| = 1 \end{aligned}$$

$$E(f) = 1 + 1 = 2$$

Is there a better mapping?

Variations

- Different weights on different relations
- Normalize error by dividing by total possible
- Attributed relational distance for attributed relations
- Penalizing for NIL mappings

Implementation

- Relational distance requires finding the lowest cost mapping from object features to image features.
- It is typically done using a branch and bound tree search.
- The search keeps track of the error after each object part is assigned an image feature.
- When the error becomes higher than the best mapping found so far, it backs up.
- It can also use discrete relaxation or forward checking (see Russel AI book on Constraint Satisfaction) to prune the search.

4. Continuous Relaxation

- In discrete relaxation, a label for a unit is either possible or not.
- In continuous relaxation, each (unit, label) pair has a probability.
- Every label for unit i has a prior probability.
- A set of **compatibility coefficients** $C = \{c_{ij}\}$ gives the influence that the label of unit i has on the label of unit j .
- The relationship R is replaced by a set of **unit/label compatibilities** where $r_{ij}(l, l')$ is the compatibility of label l for part i with label l' for part j .
- An **iterative process updates the probability** of each label for each unit in terms of its previous probability and the compatibilities of its current labels and those of other units that influence it.

Continuous Relaxation Updates

$$pr_i^0(l) = pr_i(l)$$

Initialize probability of label l for part i to the *a priori* probability.

$$q_i^k(l) = \sum_{\{j | (i,j) \in R_P\}} c_{ij} \left[\sum_{l' \in L_j} r_{ij}(l, l') pr_j^k(l') \right]$$

At step k , compute a multiplicative factor based on looking at every other part j , how much i and j constrain one another, the possible labels for part j , their current probabilities and their compatibility with label l .

$$pr_i^{k+1}(l) = \frac{pr_i^k(l)(1 + q_i^k(l))}{\sum_{l' \in L_i} pr_i^k(l')(1 + q_i^k(l'))}$$

Recognition by Appearance

- Appearance-based recognition is a competing paradigm to features and alignment.
- No features are extracted.
- Images are represented by basis functions (eigenvectors) and their coefficients.
- Matching is performed on this compressed image representation.

Eigenvectors and Eigenvalues

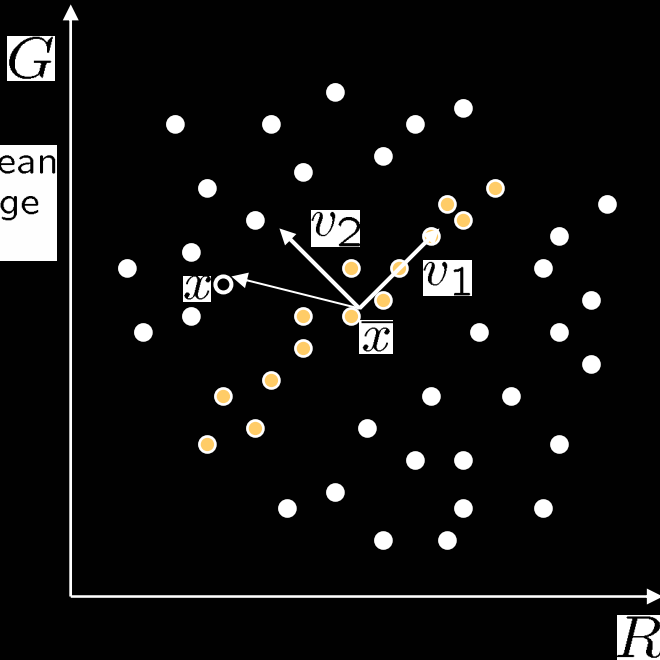

\bar{x} is the mean of the orange points

Consider the sum squared distance of a point \mathbf{x} to all of the orange points:

$$SSD(\mathbf{v}) = \sum_{\text{orange point } \mathbf{x}} \|(\mathbf{x} - \bar{\mathbf{x}})^T \cdot \mathbf{v}\|^2$$

What unit vector \mathbf{v} minimizes SSD?

$$\mathbf{v}_2 = \min_{\mathbf{v}} \{SSD(\mathbf{v})\}$$

What unit vector \mathbf{v} maximizes SSD?

$$\mathbf{v}_1 = \max_{\mathbf{v}} \{SSD(\mathbf{v})\}$$

$$\begin{aligned} SSD(\mathbf{v}) &= \sum_{\mathbf{x}} \|(\mathbf{x} - \bar{\mathbf{x}})^T \cdot \mathbf{v}\|^2 \\ &= \sum_{\mathbf{x}} \mathbf{v}^T (\mathbf{x} - \bar{\mathbf{x}}) (\mathbf{x} - \bar{\mathbf{x}})^T \mathbf{v} \\ &= \mathbf{v}^T \left[\sum_{\mathbf{x}} (\mathbf{x} - \bar{\mathbf{x}}) (\mathbf{x} - \bar{\mathbf{x}})^T \right] \mathbf{v} \\ &= \mathbf{v}^T \mathbf{A} \mathbf{v} \quad \text{where } \mathbf{A} = \sum_{\mathbf{x}} (\mathbf{x} - \bar{\mathbf{x}}) (\mathbf{x} - \bar{\mathbf{x}})^T \end{aligned}$$

Solution: \mathbf{v}_1 is eigenvector of \mathbf{A} with *largest* eigenvalue
 \mathbf{v}_2 is eigenvector of \mathbf{A} with *smallest* eigenvalue

Principle component analysis

- Suppose each data point is N-dimensional
 - Same procedure applies:

$$\begin{aligned} SSD(\mathbf{v}) &= \sum_{\mathbf{x}} \|(\mathbf{x} - \bar{\mathbf{x}})^T \cdot \mathbf{v}\|^2 \\ &= \mathbf{v}^T \mathbf{A} \mathbf{v} \quad \text{where } \mathbf{A} = \sum_{\mathbf{x}} (\mathbf{x} - \bar{\mathbf{x}})(\mathbf{x} - \bar{\mathbf{x}})^T \end{aligned}$$

- The eigenvectors of \mathbf{A} define a new coordinate system
 - eigenvector with largest eigenvalue captures the most variation among training vectors \mathbf{x}
 - eigenvector with smallest eigenvalue has least variation
- We can compress the data by only using the top few eigenvectors

The space of faces

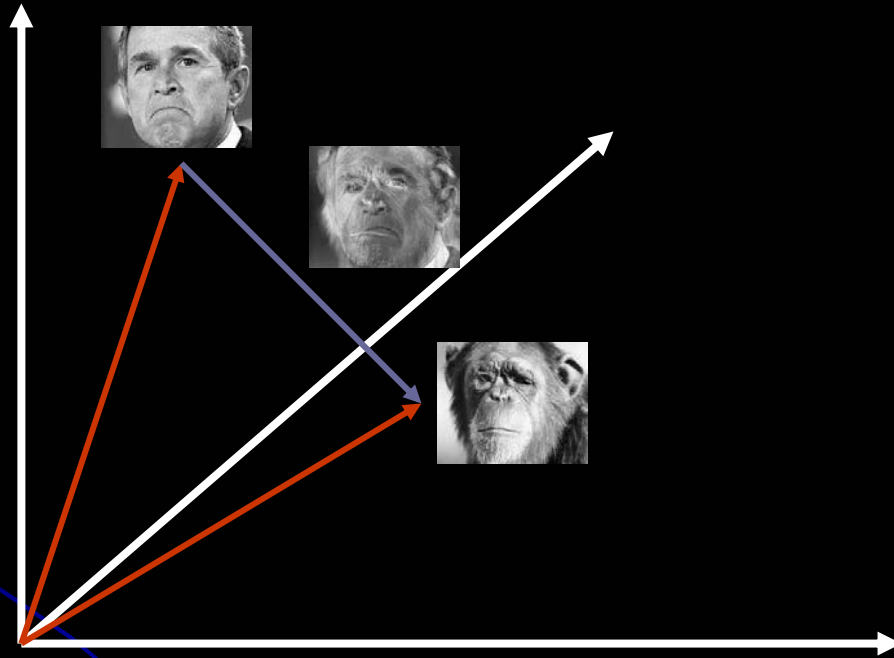

- An image is a point in a high-dimensional space
 - An $N \times M$ image is a point in \mathbb{R}^{NM}
 - We can define vectors in this space

Dimensionality reduction

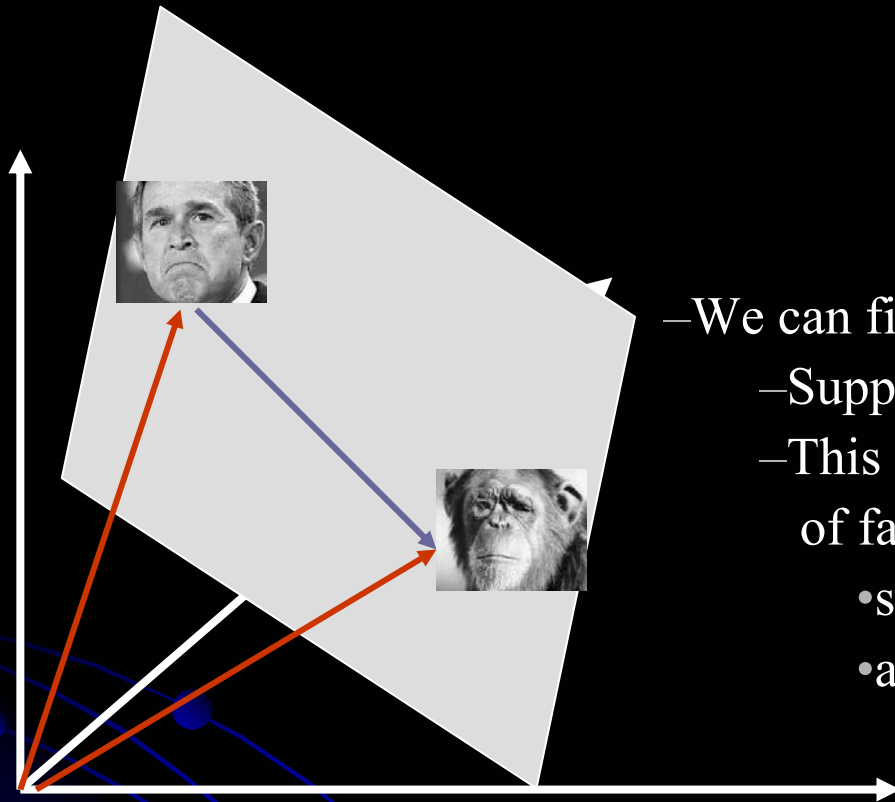

- We can find the best subspace using PCA
- Suppose it is K dimensional
- This is like fitting a “hyper-plane” to the set of faces
 - spanned by vectors $\mathbf{v}_1, \mathbf{v}_2, \dots, \mathbf{v}_K$
 - any face $\mathbf{x} \approx a_1\mathbf{v}_1 + a_2\mathbf{v}_2 + \dots + a_K\mathbf{v}_K$

The set of faces is a “subspace” of the set of images.

Turk and Pentland's Eigenfaces: Training

- Let F_1, F_2, \dots, F_M be a set of **training face images**. Let F be their mean and $\Phi_i = F_i - F$.
- Use **principal components** to compute the eigenvectors and eigenvalues of the covariance matrix.

$$C = (1/M) \sum_{i=1}^M \Phi_i \Phi_i^T$$

- Choose the vector u of most significant M eigenvectors to use as the basis.
- Each face is represented as a **linear combination of eigenfaces**

$$u = (u_1, u_2, u_3, u_4, u_5); F_{27} = a_1 * u_1 + a_2 * u_2 + \dots + a_5 * u_5$$

Matching

unknown
face image
I



convert to its
eigenface
representation



$\Omega = (\Omega_1, \Omega_2, \dots, \Omega_m)$

Find the face class k that minimizes

$$\epsilon_k = \| \Omega - \Omega_k \|$$

training
images



mean
image



Mean

MEF₁

MEF₂

MEF₃

3 eigen-
images

linear
approximations



Extension to 3D Objects

- Murase and Nayar (1994, 1995) extended this idea to 3D objects.
- The training set had **multiple views of each object**, on a dark background.
- The views included **multiple (discrete) rotations** of the object on a turntable and also **multiple (discrete) illuminations**.
- The system could be used first to **identify** the object and then to determine its (approximate) **pose** and illumination.

Sample Objects

Columbia Object Recognition Database

COLUMBIA UNIVERSITY IMAGE LIBRARY (COIL-20)



Significance of this work

- The extension to 3D objects was an important contribution.
- Instead of using brute force search, the authors observed that

All the views of a single object, when transformed into the eigenvector space became points on a manifold in that space.

- Using this, they developed fast algorithms to find the closest object manifold to an unknown input image.
- Recognition with pose finding took less than a second.

Appearance-Based Recognition

- Training images must be representative of the instances of objects to be recognized.
- The object must be well-framed.
- Positions and sizes must be controlled.
- Dimensionality reduction is needed.
- It is not powerful enough to handle general scenes without prior segmentation into relevant objects.
- * • The newer systems that use “parts” from interest operators are an answer to these restrictions.

Summary

- **2D object recognition for specific objects (usually industrial) is done by alignment.**

- Affine transformations are usually powerful enough to handle objects that are mainly two-dimensional.

- Matching can be performed by many different “graph-matching” methodologies.

- Verification is a necessary part of the procedure.

- **Appearance-based recognition is another 2D recognition paradigm that came from the need for recognizing specific instances of a general object class, motivated by face recognition.**