

Finite State Machines

CSE 311 Spring 2022
Lecture 24

Relations

Relations

A (binary) relation from A to B is a subset of $A \times B$

A (binary) relation on A is a subset of $A \times A$

Wait what?

$$\{1, 2\} \times \{a, b\} = \{(1, a), (1, b), (2, a), (2, b)\}$$

\leq is a relation on \mathbb{Z} .

" $3 \leq 4$ " is a way of saying "3 relates to 4" (for the \leq relation)

$(3, 4)$ is an element of the set that defines the relation.

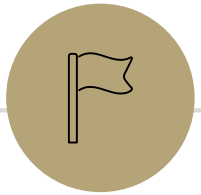

Graphs



Directed Graphs

$$G = (V, E)$$

V is a set of vertices (an underlying set of elements)

E is a set of edges (ordered pairs of vertices; i.e. connections from one to the next).

Path v_0, v_1, \dots, v_k such that $(v_i, v_{i+1}) \in E$

Simple Path: path with all v_i distinct

Cycle: path with $v_0 = v_k$ (and $k > 0$)

Simple Cycle: simple path plus edge (v_k, v_0) with $k > 0$

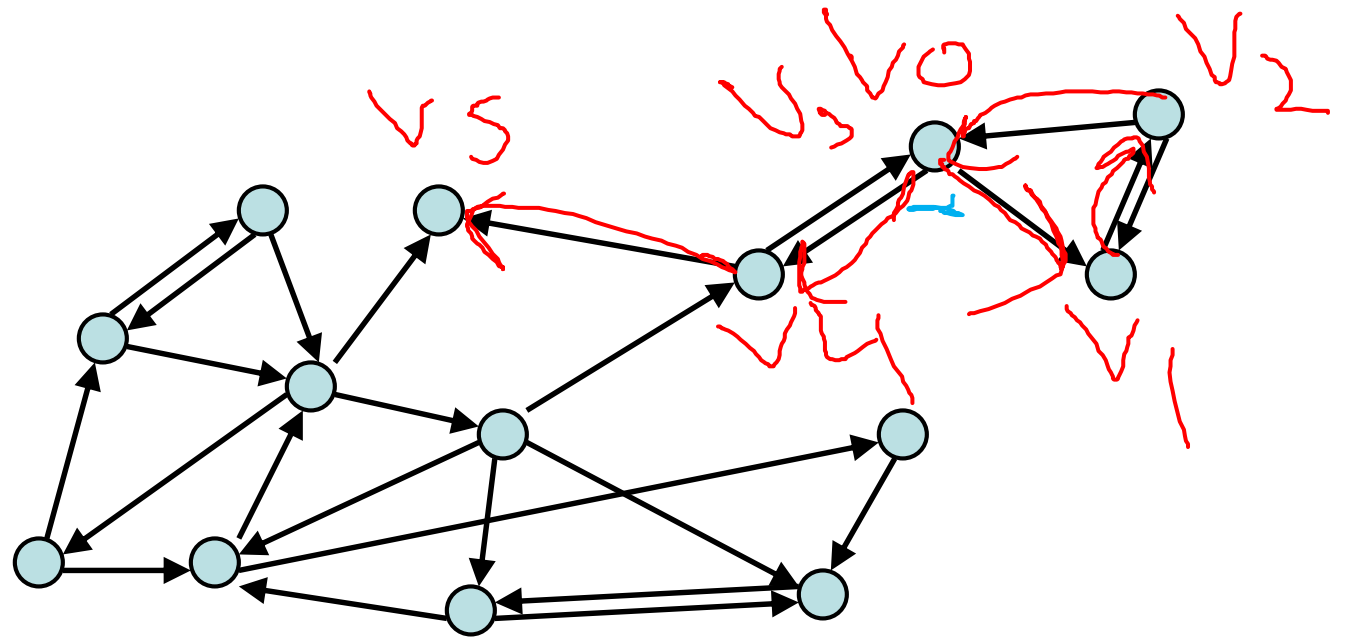

Directed Graphs

$$G = (V, E)$$

V is a set of vertices (an underlying set of elements)

E is a set of edges (ordered pairs of vertices; i.e. connections from one to the next).

Path v_0, v_1, \dots, v_k such that $(v_i, v_{i+1}) \in E$

Simple Path: path with all v_i distinct

Cycle: path with $v_0 = v_k$ (and $k > 0$)

Simple Cycle: simple path plus edge (v_k, v_0) with $k > 0$

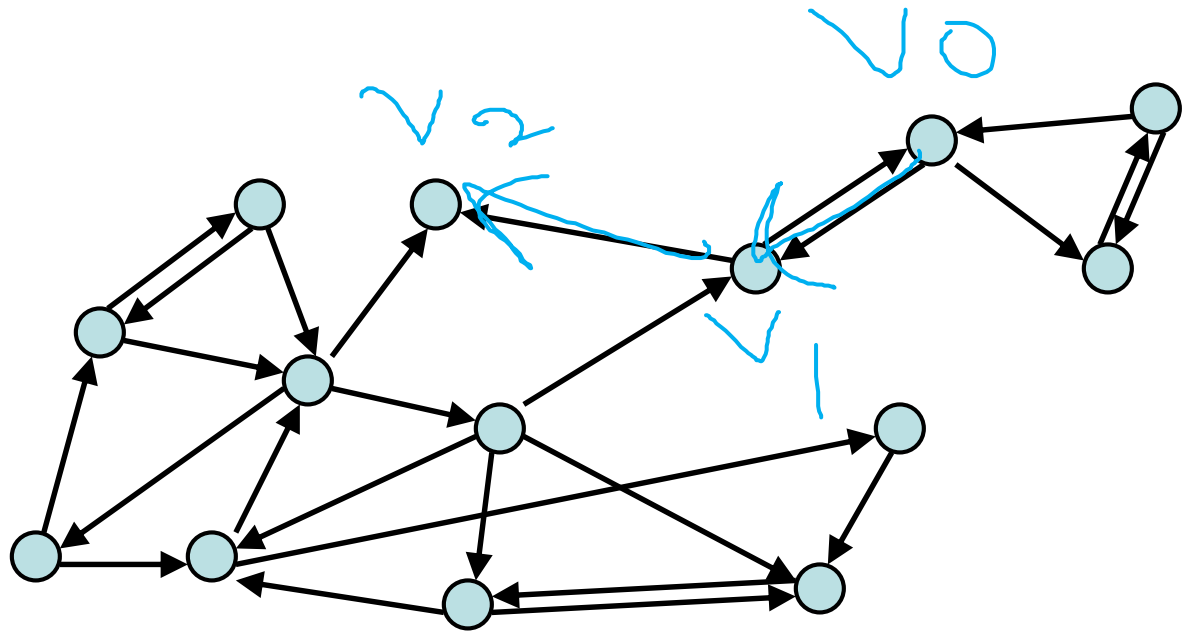

Directed Graphs

$$G = (V, E)$$

V is a set of vertices (an underlying set of elements)

E is a set of edges (ordered pairs of vertices; i.e. connections from one to the next).

Path v_0, v_1, \dots, v_k such that $(v_i, v_{i+1}) \in E$

Simple Path: path with all v_i distinct

Cycle: path with $v_0 = v_k$ (and $k > 0$)

Simple Cycle: simple path plus edge (v_k, v_0) with $k > 0$

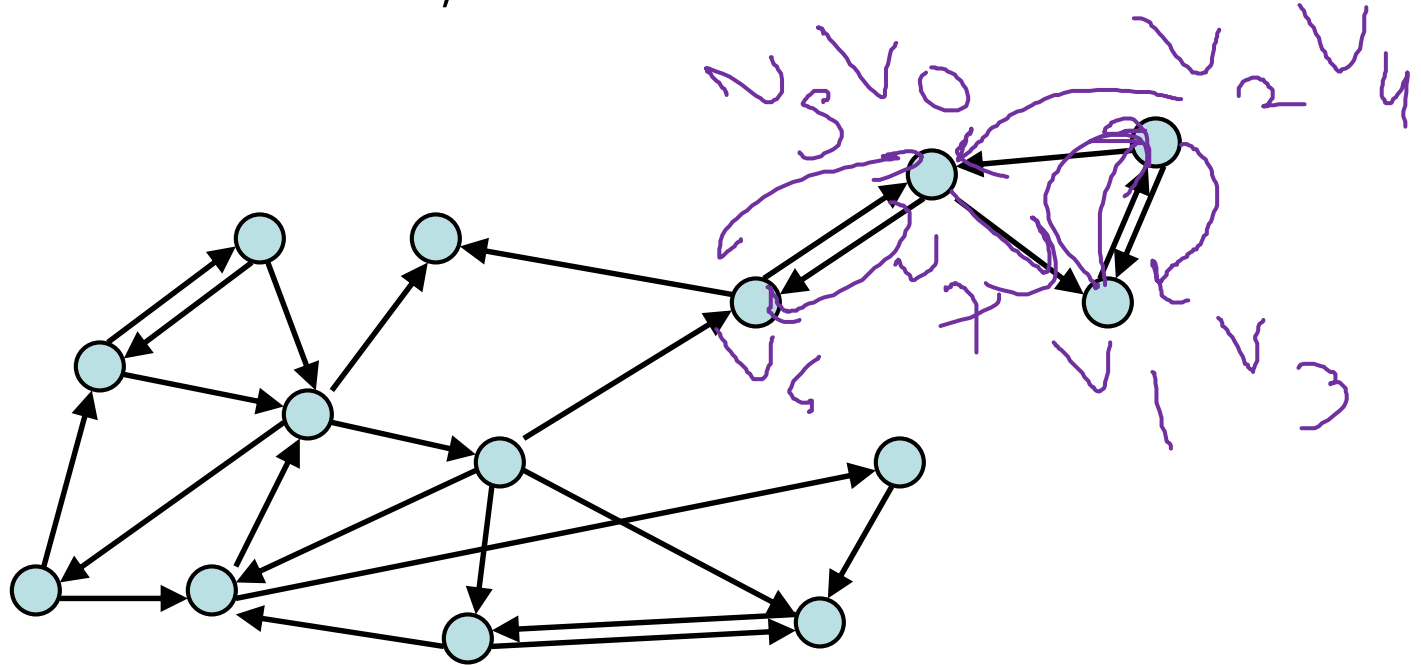

Directed Graphs

$$G = (V, E)$$

V is a set of vertices (an underlying set of elements)

E is a set of edges (ordered pairs of vertices; i.e. connections from one to the next).

Path v_0, v_1, \dots, v_k such that $(v_i, v_{i+1}) \in E$

Simple Path: path with all v_i distinct

Cycle: path with $v_0 = v_k$ (and $k > 0$)

Simple Cycle: simple path plus edge (v_k, v_0) with $k > 0$

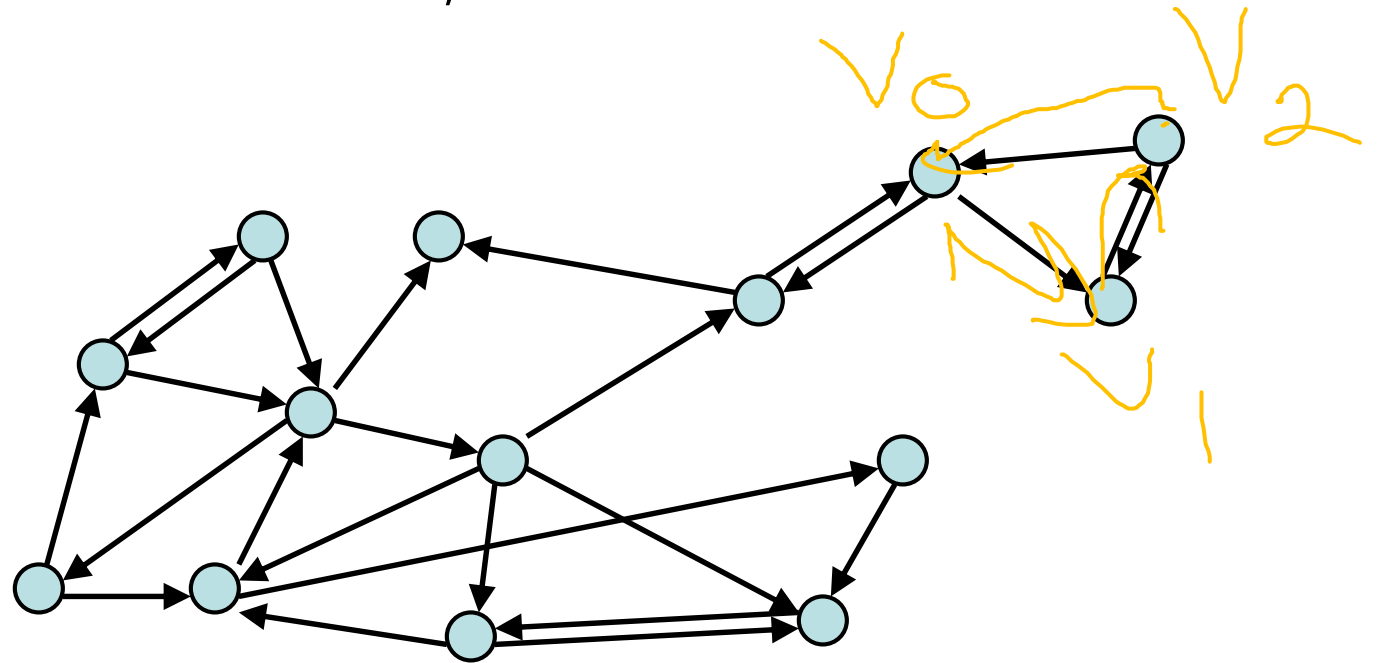

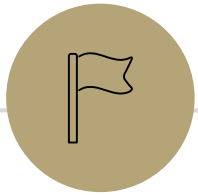

Lecture-Only Content

Relations and Graphs

More Relations and Graphs

The rest of this deck is a little more on:

Relations, specifically combining them together

Graphs, specifically representing relations as graphs.

We're going to go through it *very* fast. We won't have homework or exam questions on anything in this section of the deck.

But it is stuff you should see at least once because it might come back in future classes.

Combining Relations

Given a relation R from A to B

And a relation S from B to C ,

$$f(g(x))$$

The relation $S \circ R$ from A to C is

$$\{(a, c) : \exists b[(a, b) \in R \wedge (b, c) \in S]\}$$

Yes, I promise it's $S \circ R$ not $R \circ S$ – it makes more sense if you think about relations $(x, f(x))$ and $(x, g(x))$

But also don't spend a ton of energy worrying about the order, we almost always care about $R \circ R$, where order doesn't matter.

Combining Relations

To combine relations, it's a lot easier if we can see what's happening.

We'll use a representation of a directed graph

Representing Relations

To represent a relation R on a set A , have a vertex for each element of A and have an edge (a, b) for every pair in R .

Let A be $\{1,2,3,4\}$ and R be $\{(1,1), (1,2), (2,1), (2,3), (3,4)\}$



Combining Relations

If $S = \{(2, 2), (2, 3), (3, 1)\}$ and $R = \{(1, 2), (2, 1), (1, 3)\}$

Compute $S \circ R$ i.e. every pair (a, c) with a b with $(a, b) \in R$ and $(b, c) \in S$

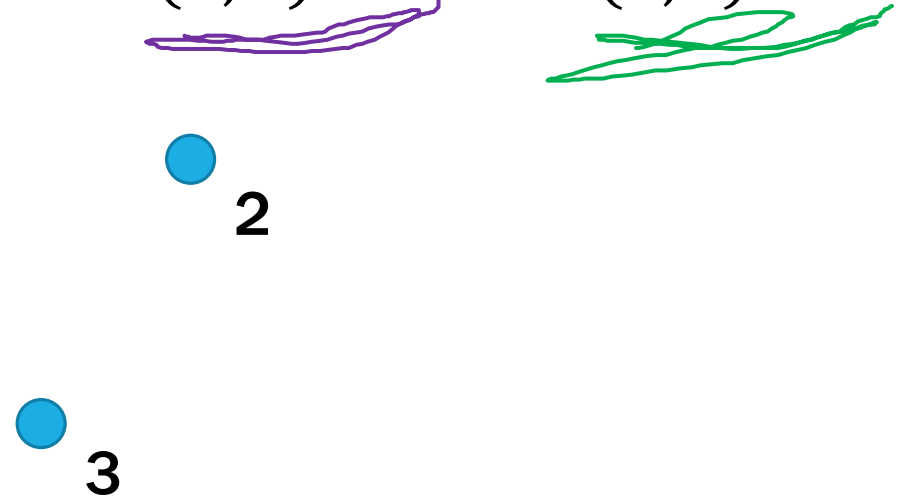
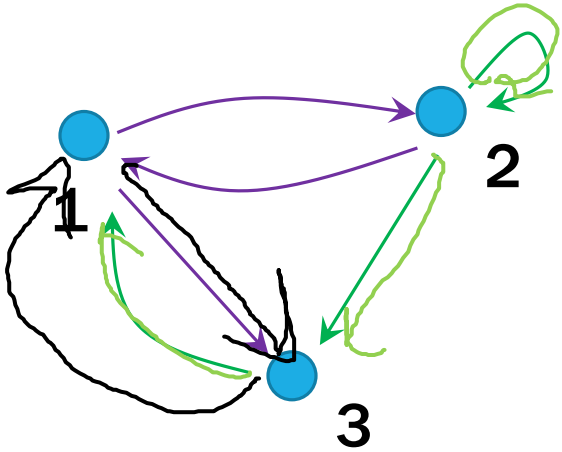

Combining Relations

If $S = \{(2, 2), (2, 3), (3, 1)\}$ and $R = \{(1, 2), (2, 1), (1, 3)\}$

Compute $S \circ R$ i.e. every pair (a, c) with a b with $(a, b) \in R$ and $(b, c) \in S$

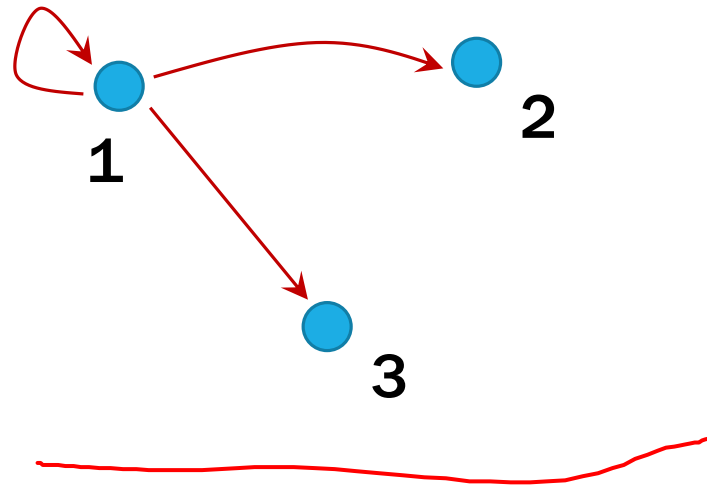
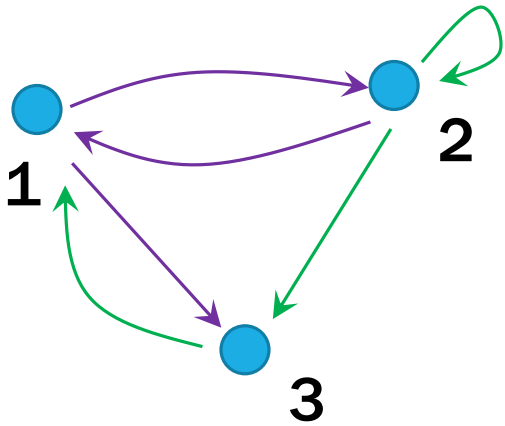

Combining Relations

Let R be a relation on A .

Define R^0 as $\{(a, a) : a \in A\}$

$$R^k = R^{k-1} \circ R$$

$(a, b) \in R^k$ if and only if there is a path of length k from a to b in R .

We can find that on the graph!

More Powers of R .

For two vertices in a graph, a can reach b if there is a path from a to b .

Let R be a relation on the set A . The connectivity relation R^* consists of all pairs (a, b) such that a can reach b (i.e. there is a path from a to b in R)

$$R^* = \bigcup_{k=0}^{\infty} R^k$$

Note we're starting from 0 (the textbook makes the unusual choice of starting from $k = 1$).

What's the point of R^*

R^* is also the “reflexive-transitive closure of R .”

It answers the question “what's the minimum amount of edges I would need to add to R to make it reflexive and transitive?”

Why care about that? The transitive-reflexive closure can be a summary of data – you might want to precompute it so you can easily check if a can reach b instead of recomputing it every time.

What's the point of R^* ?

Do you need to take 142 before you take 311?

CSE311: Foundations of Computing I

Catalog Description: Examines fundamentals of logic, set theory, induction, and algebraic structures with applications to computing; finite state machines; and limits of computability. Prerequisite: CSE 143; either MATH 126 or MATH 136.

Prerequisites: CSE 143; either MATH 126 or MATH 136.



CSE143: Computer Programming II

Catalog Description: Continuation of 142. Concepts of data abstraction and encapsulation including stacks, queues, linked lists, binary trees, recursion, instruction to complexity and use of predefined collection classes.

Prerequisites: CSE 142.



Relations and Graphs

Describe how each property will show up in the graph of a relation.

Reflexive

Symmetric

Antisymmetric

Transitive

Relations and Graphs

Describe how each property will show up in the graph of a relation.

Reflexive

Every vertex has a "self-loop" (an edge from the vertex to itself)

Symmetric

Every edge has its "reverse edge" (going the other way) also in the graph.

Antisymmetric

No edge has its "reverse edge" (going the other way) also in the graph.

Transitive

If there's a length-2 path from a to b then there's a direct edge from a to b



Finite State Machines

The rest of this deck is "fair game" for homework and exams.

Last Two Weeks

What computers can and can't do...

Given any finite amount of time.

We'll start with a simple model of a computer – finite state machines.

What do we want computers to do? Let's start very simple.

We'll give them an input (in a string format), and we want them to say "yes" or "no" for that string on a certain question.

Example questions one might want to answer.

Does this input java code compile to a valid program?

Does this input string match a particular regular expression?

Is this input list sorted?

Depending on the "computer" some questions might be out of reach.

Deterministic Finite Automaton

Our machine is going to get a string as input. It will read one character at a time and update "its state." At every step, the machine thinks of itself as in one of the (finite number) vertices. When it reads the character it follows the arrow labeled with that character to its next state.

Start at the "start state" (unlabeled, incoming arrow). After you've read the last character, accept the string if and only if you're in a "final state" (double circle).

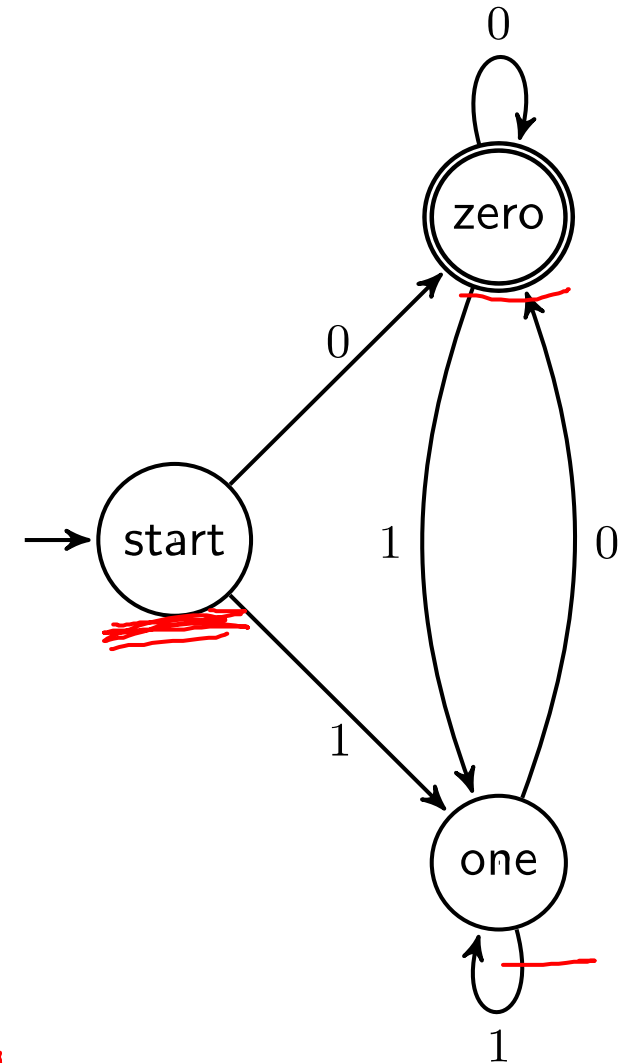

Let's see an example

Input string:

011 *reject*

1010

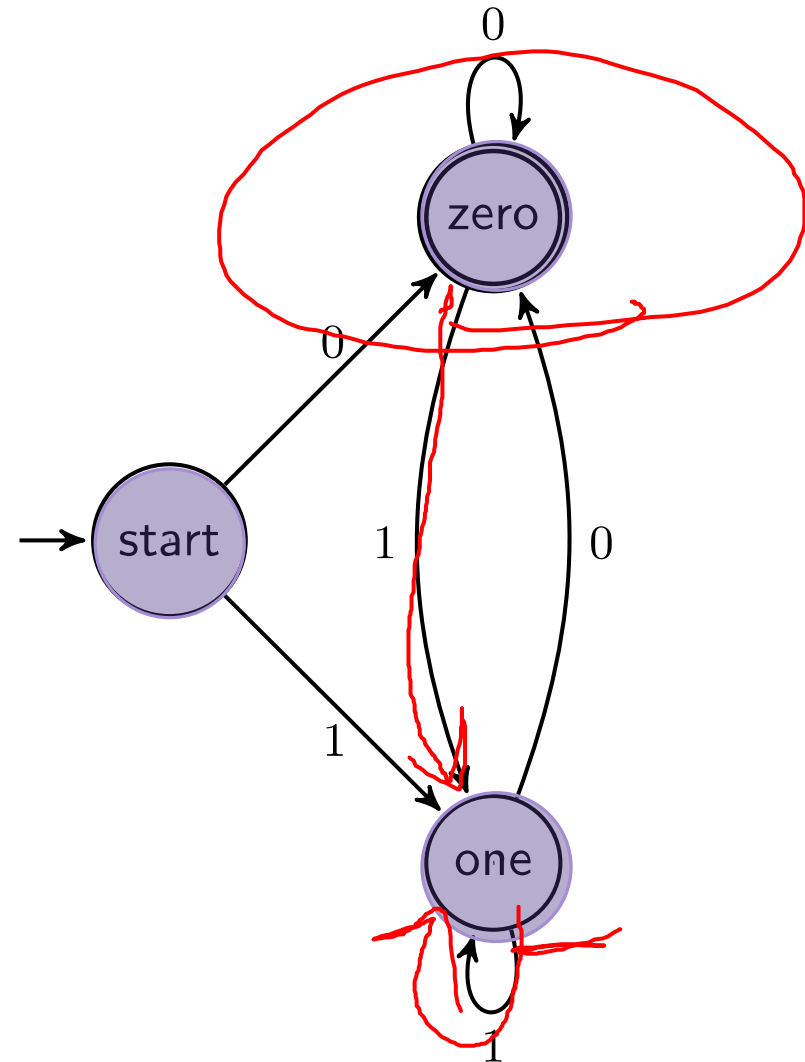

Let's see an example

Input string:

011

1010

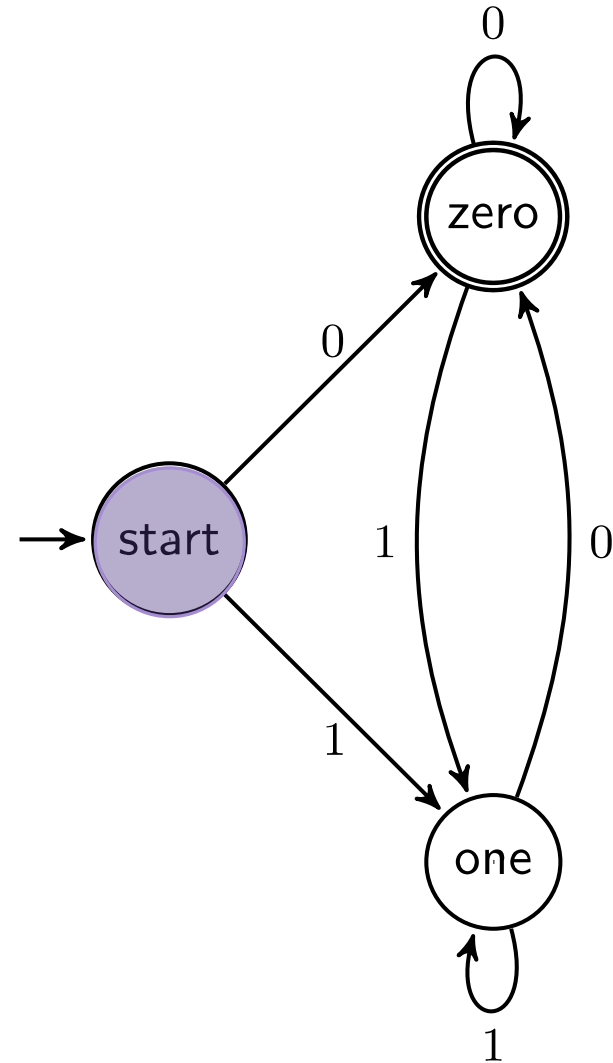

Let's see an example

Input string:

011

1010

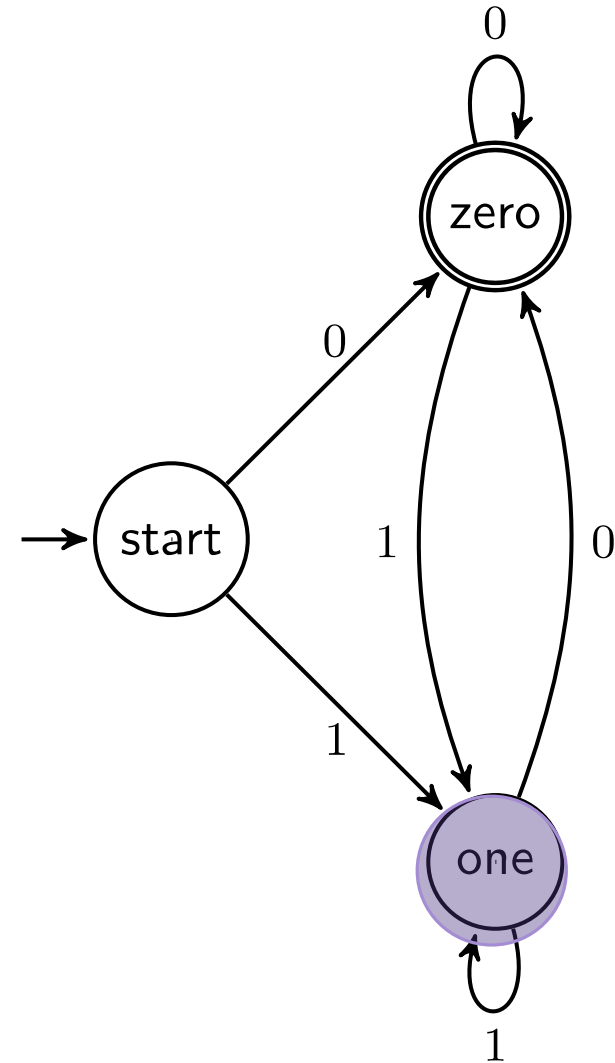

Let's see an example

Input string:

011

1010

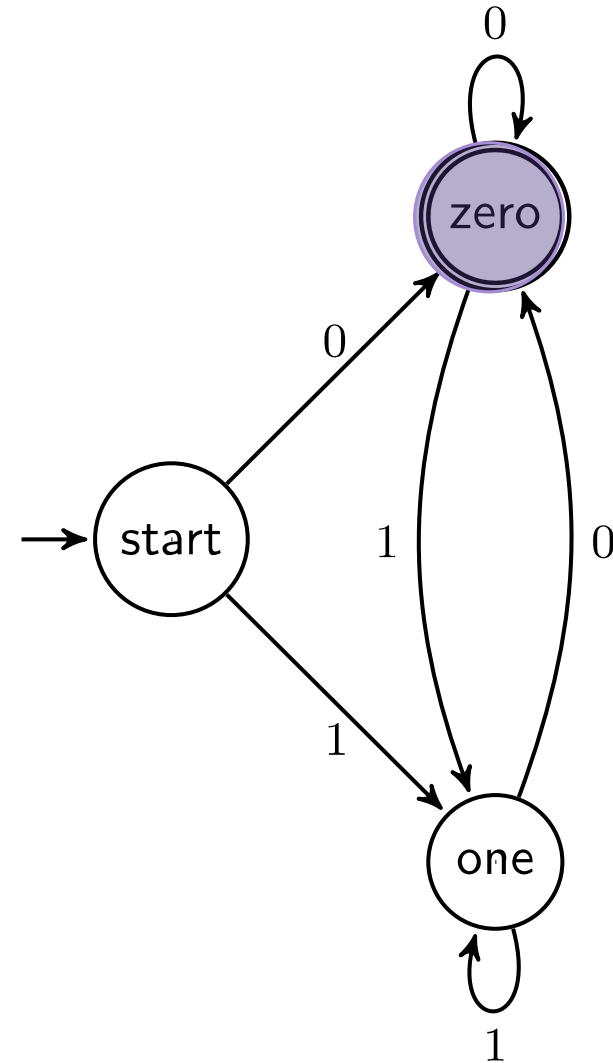

Let's see an example

Input string:

011

1010

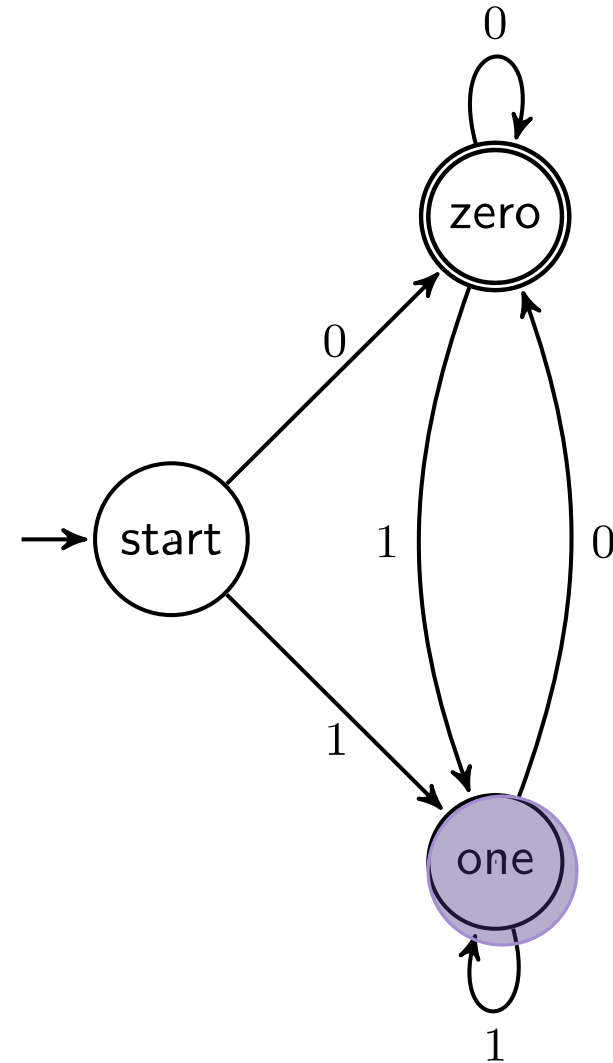

Let's see an example

Input string:

011

1010



accept

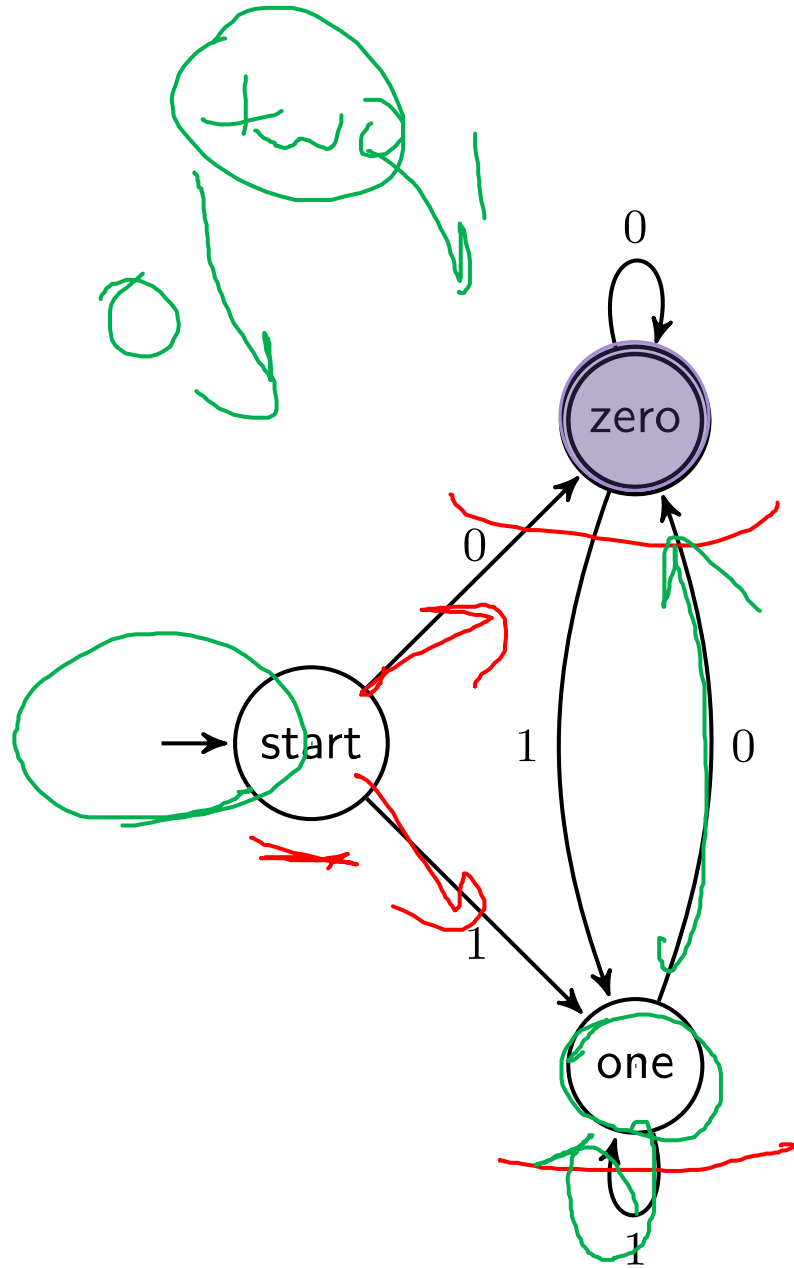

Deterministic Finite Automata

Some more requirements:

Every machine is defined with respect to an alphabet Σ

Every state has exactly one outgoing edge for every character in Σ .

There is exactly one start state; can have as many accept states (aka final states) as you want – including none.

Deterministic Finite Automata

Can also represent transitions with a table.

Old State	0	1
s_0	s_0	s_1
s_1	s_0	s_2
s_2	s_0	s_3
s_3	s_3	s_3

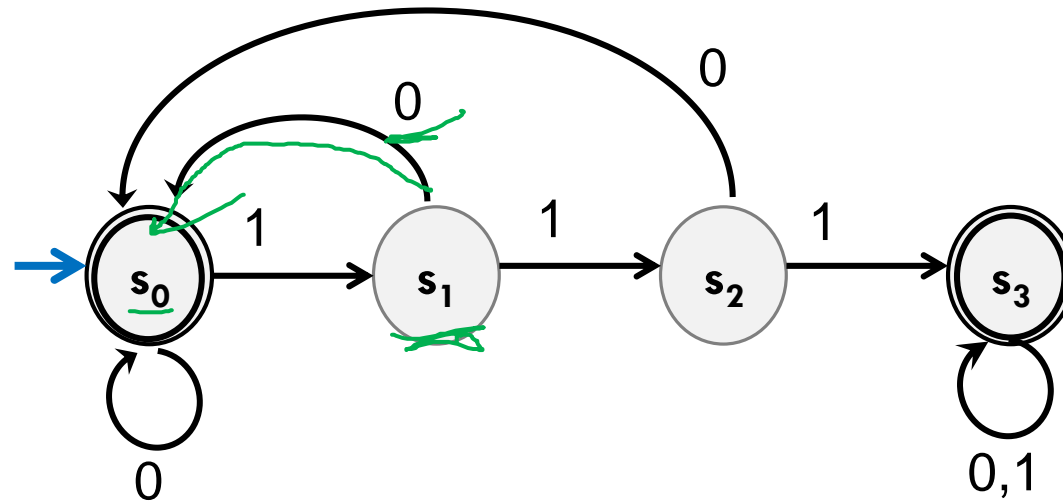

Deterministic Finite Automata

What is the language of this DFA?

I.e. the set of all strings it accepts?

*any string w/ 3 ones in a row
any " ends in 0
empty string*

Old State	0	1
s_0	s_0	s_1
s_1	s_0	s_2
s_2	s_0	s_3
s_3	s_3	s_3

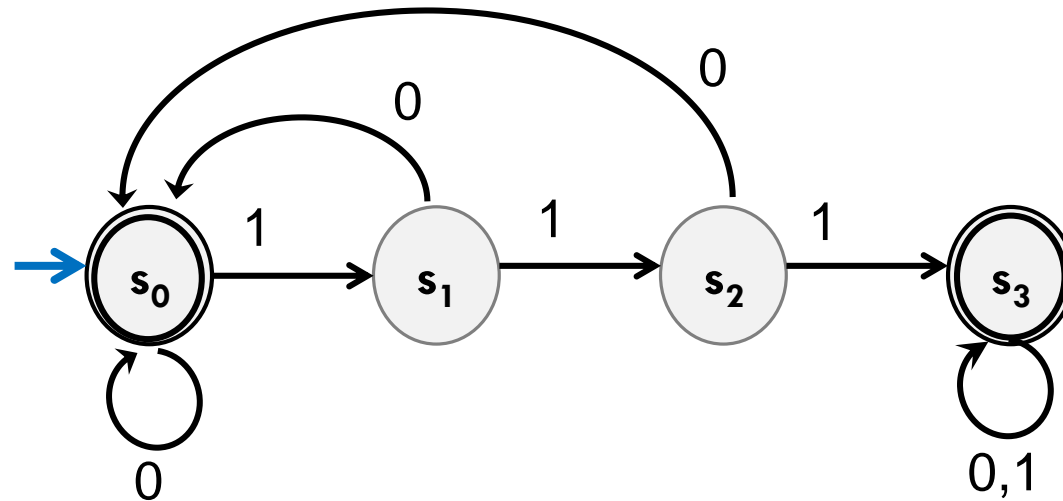

Deterministic Finite Automata

If the string has 111, then you'll end up in s_3 and never leave.

If you end with a 0 you're back in s_0 which also accepts.

And... ϵ is also accepted

$$[(0 \cup 1)^* 111(0 \cup 1)^*] \cup [(0 \cup 1)^* 0]^*$$

Old State	0	1
s_0	s_0	s_1
s_1	s_0	s_2
s_2	s_0	s_3
s_3	s_3	s_3

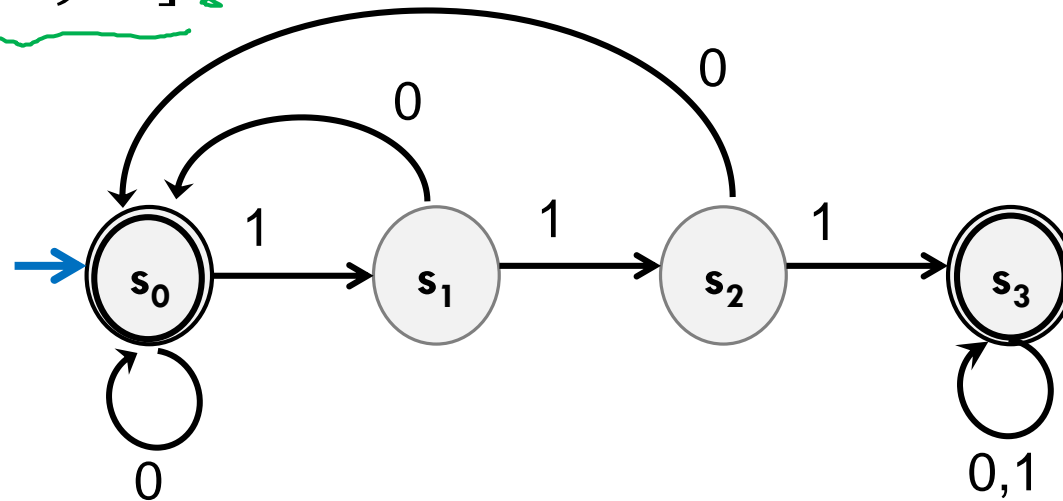

Design some DFAs

Let $\Sigma = \{0,1,2\}$

M_1 should recognize "strings with an even number of 2's."

What do you need to remember?

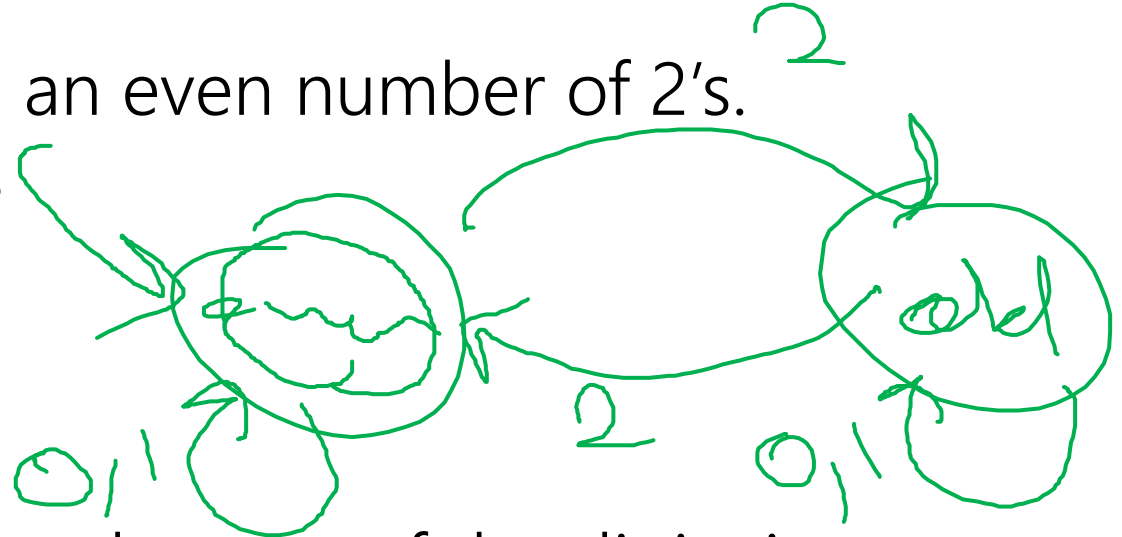

M_2 should recognize "strings where the sum of the digits is congruent to 0 (*mod* 3)"

Design some DFAs

Let $\Sigma = \{0,1,2\}$

M_1 should recognize "strings with an even number of 2's."

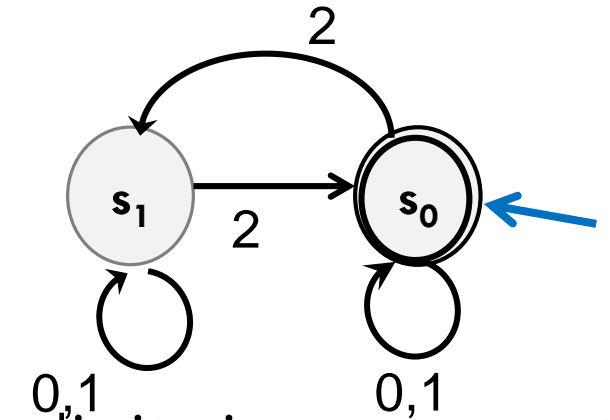

M_2 should recognize "strings where the sum of the digits is congruent to 0 (mod 3)"

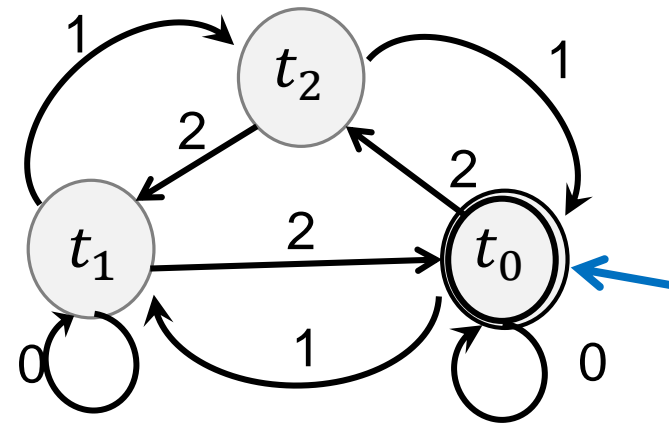

Designing DFAs notes

DFAs can't "count arbitrarily high"

For example, we could not make a DFA that remembers the overall sum of all the digits (not taken % 3)

That would have infinitely many states! We're only allowed a finite number.

Strings over $\{0,1,2\}$ w/ even number of 2's
and $\text{sum} \% 3 = 0$

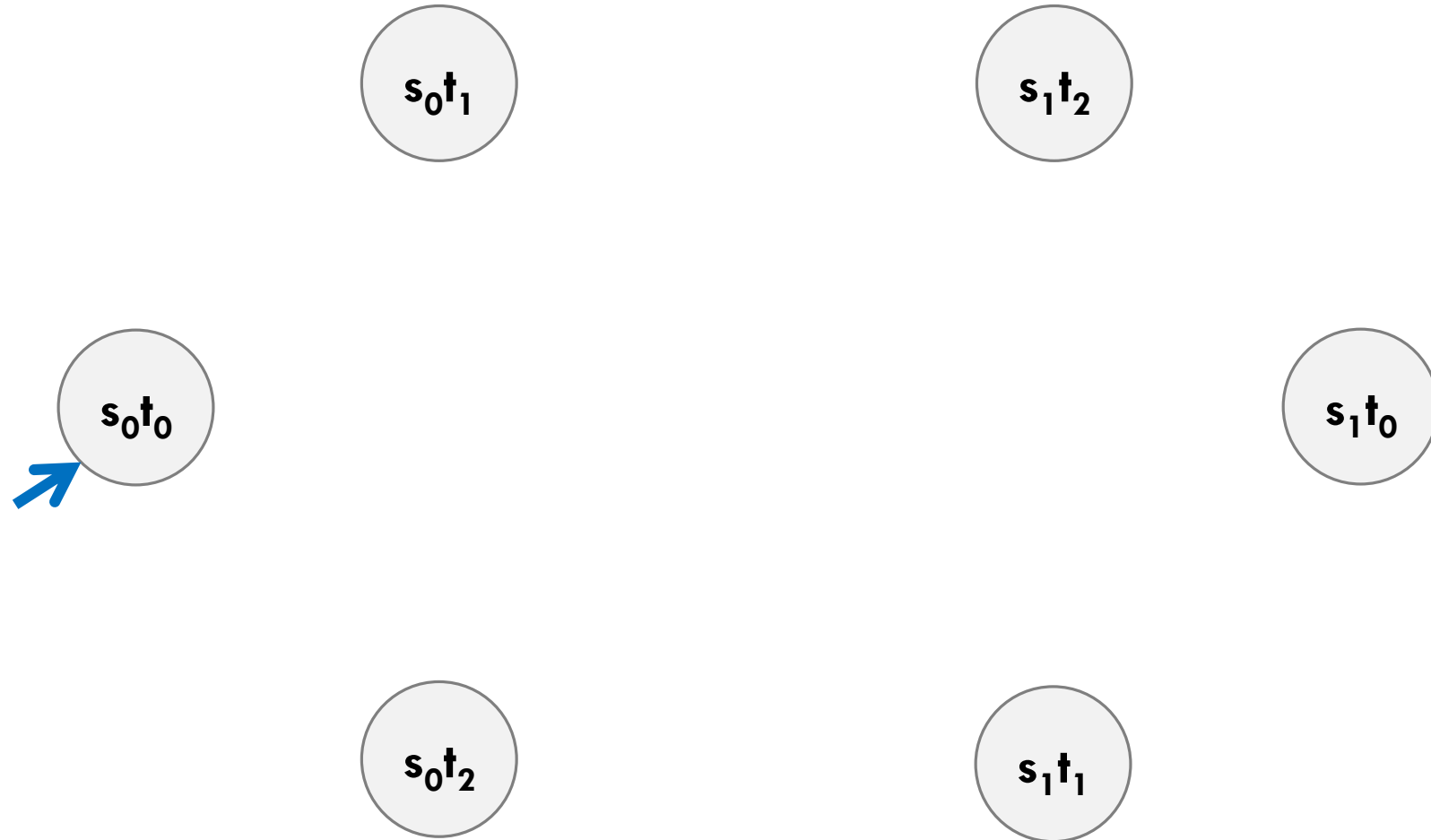

Strings over $\{0,1,2\}$ w/ even number of 2's **and** $\text{sum} \% 3 = 0$

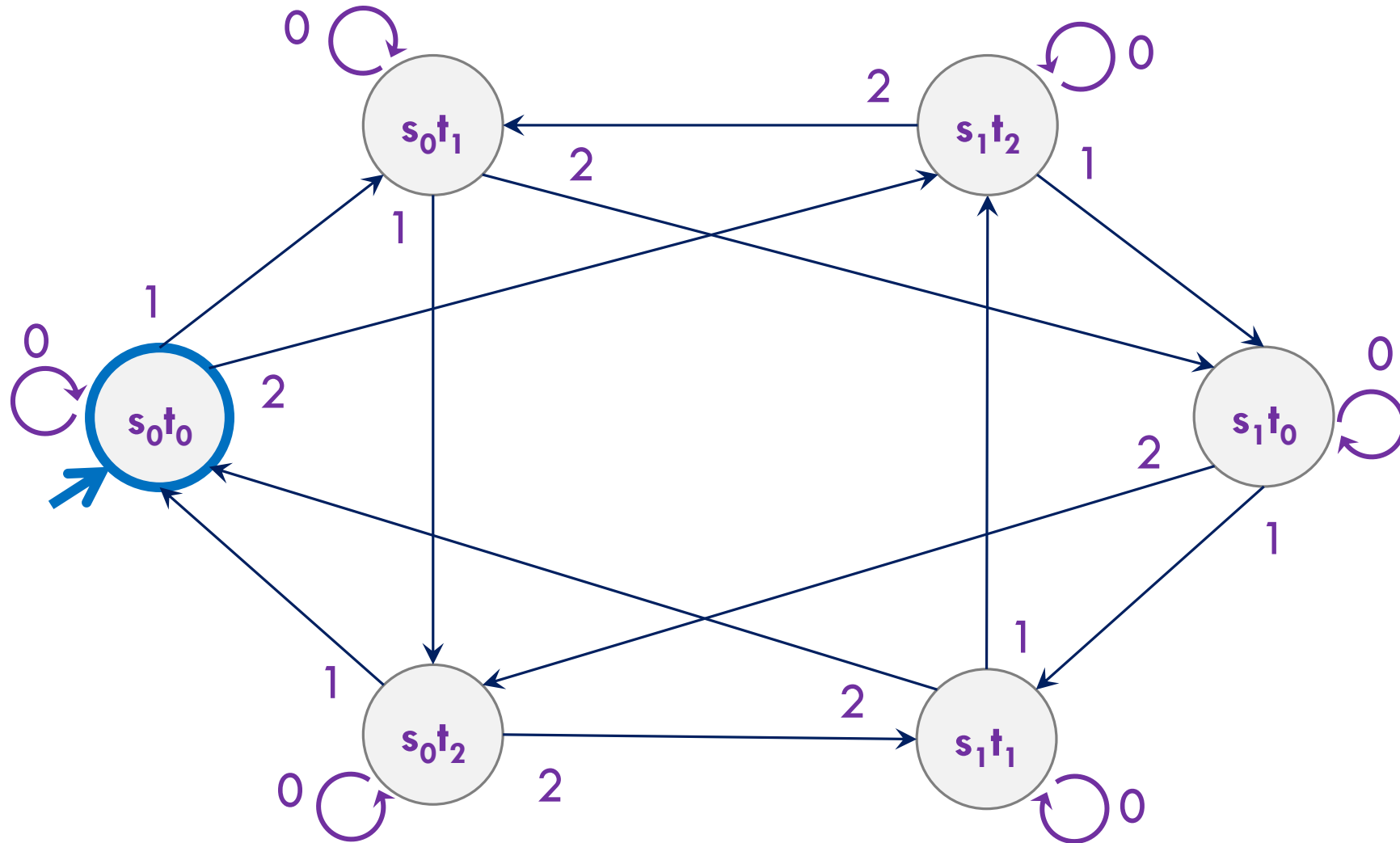

Strings over $\{0,1,2\}$ w/ even number of 2's **and**
 $\text{sum} \% 3 = 0$

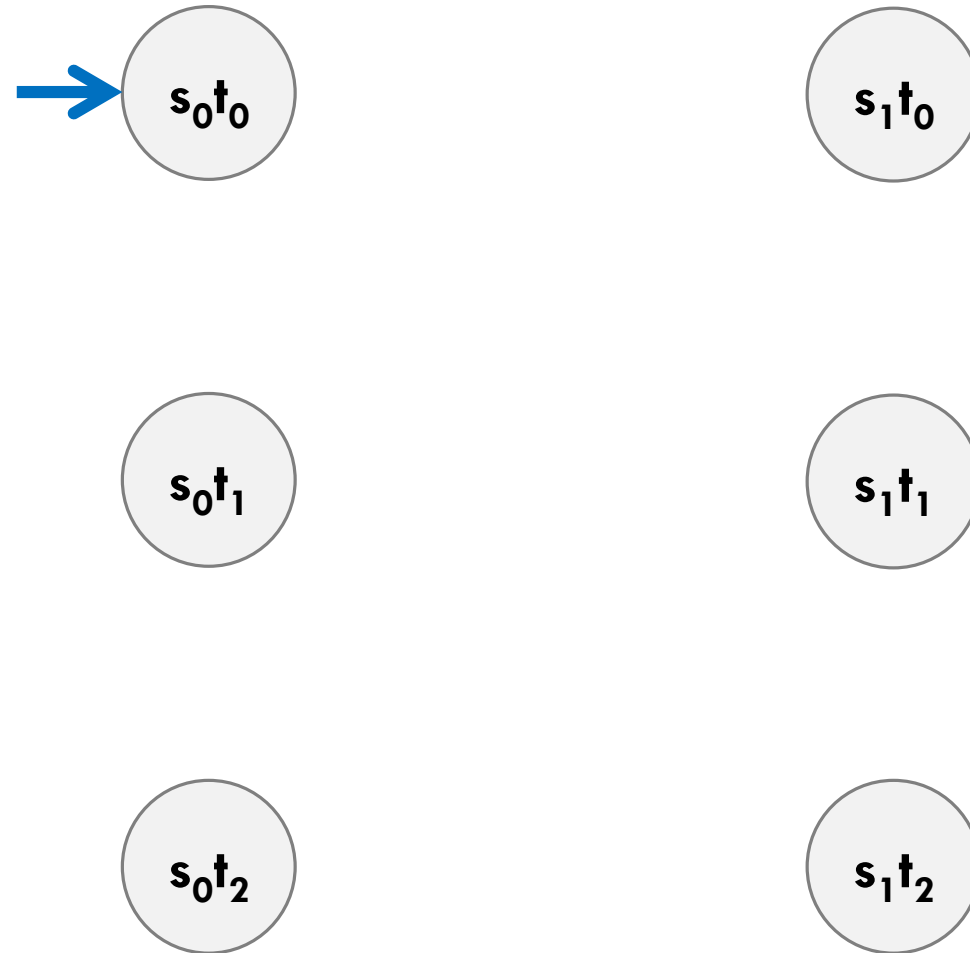

Strings over $\{0,1,2\}$ w/ even number of 2's and $\text{sum} \% 3 = 0$

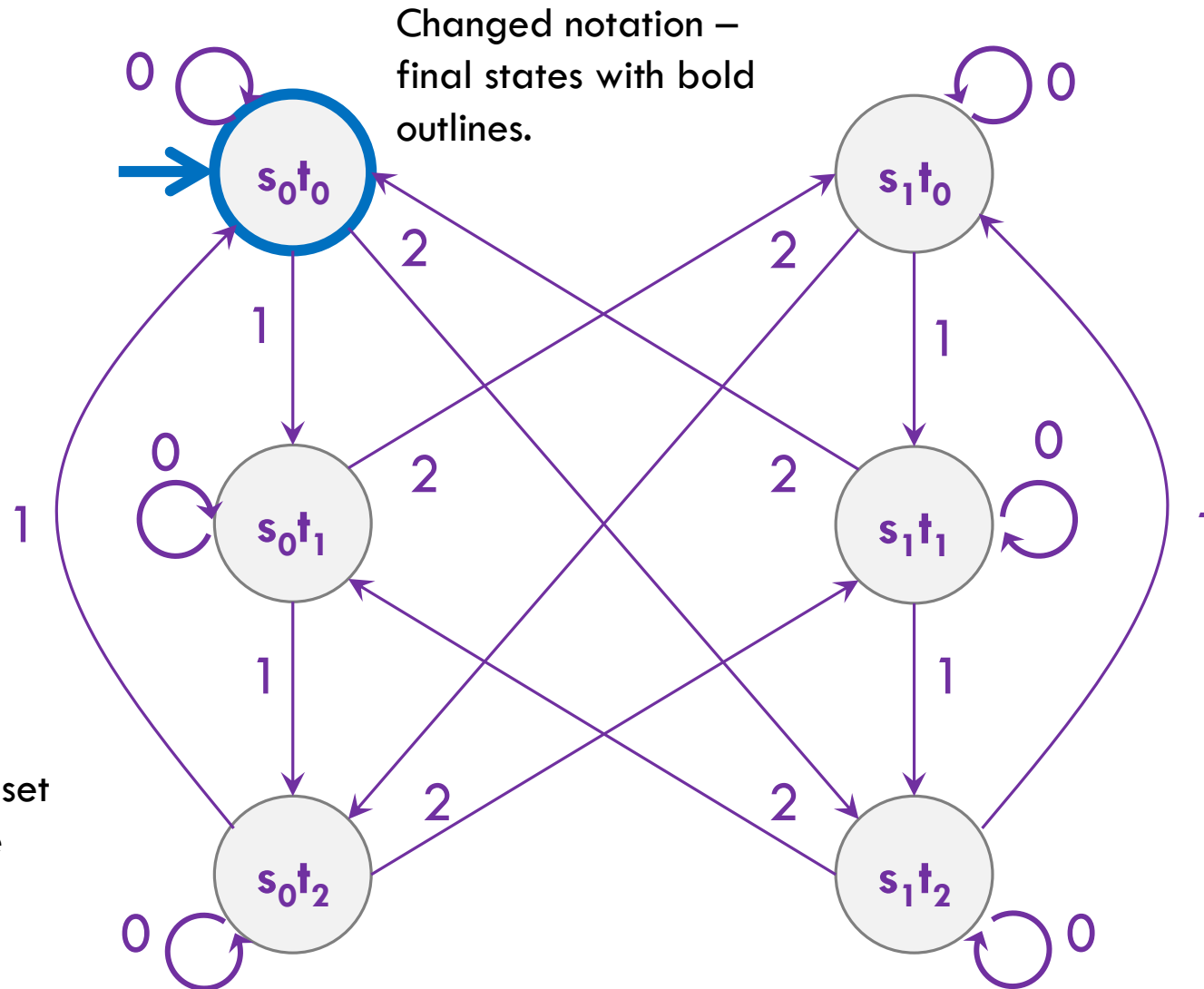

Called the “cross product” construction (because you have a set of states equal to $Q_1 \times Q_2$ where first two DFAs had states Q_1, Q_2). A very common trick to combine DFAs.

Strings over $\{0,1,2\}$ w/ even number of 2's and $\text{sum} \% 3 = 0$

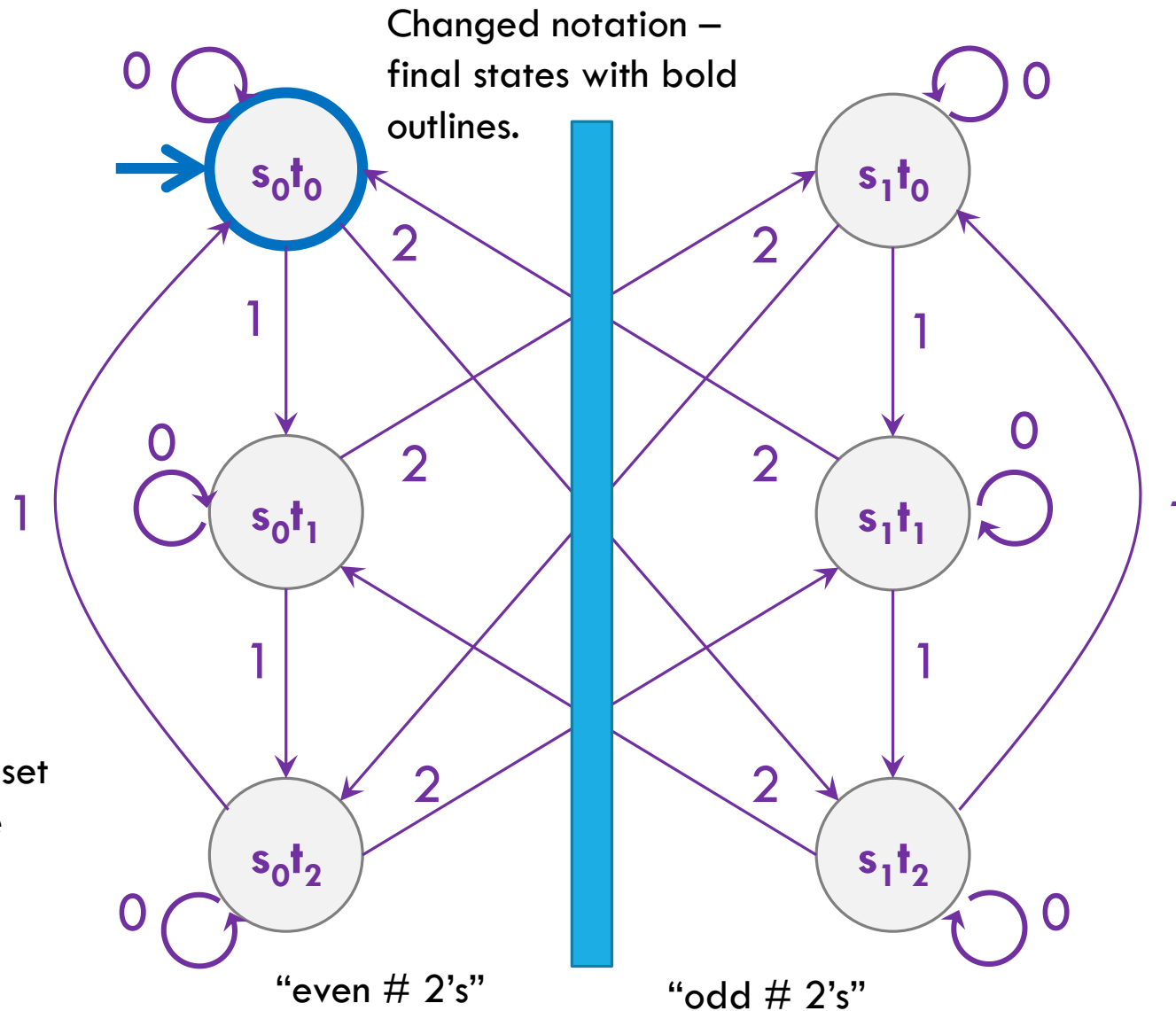

Called the “cross product” construction (because you have a set of states equal to $Q_1 \times Q_2$ where first two DFAs had states Q_1, Q_2). A very common trick to combine DFAs.

Strings over $\{0,1,2\}$ w/ even number of 2's and $\text{sum} \% 3 = 0$

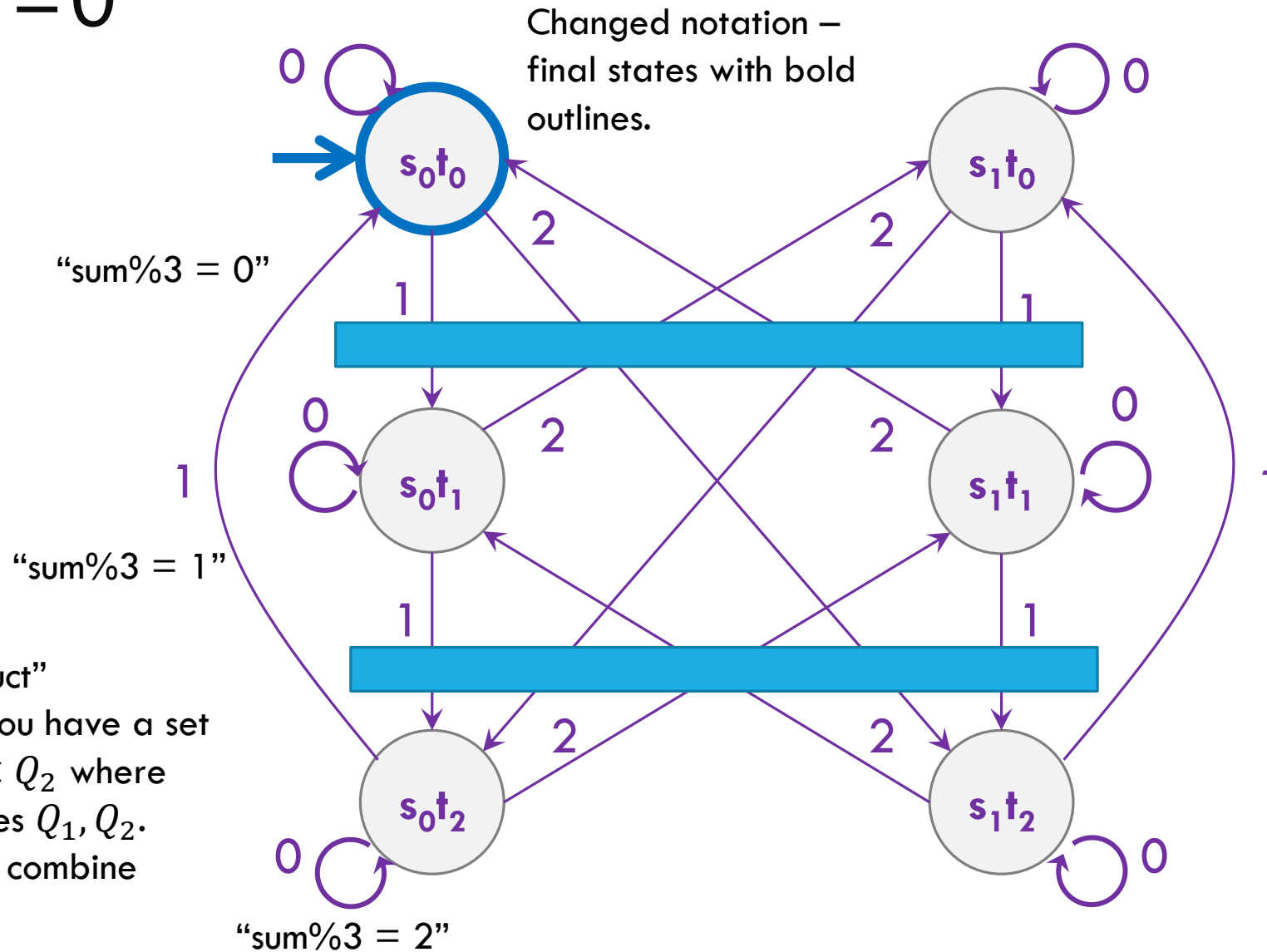

Called the “cross product” construction (because you have a set of states equal to $Q_1 \times Q_2$ where first two DFAs had states Q_1, Q_2). A very common trick to combine DFAs.

Strings over $\{0,1,2\}$ w/ even number of 2's **OR** $\text{sum} \% 3 = 0$

Want to change the and to or – don't need to change states or transitions...

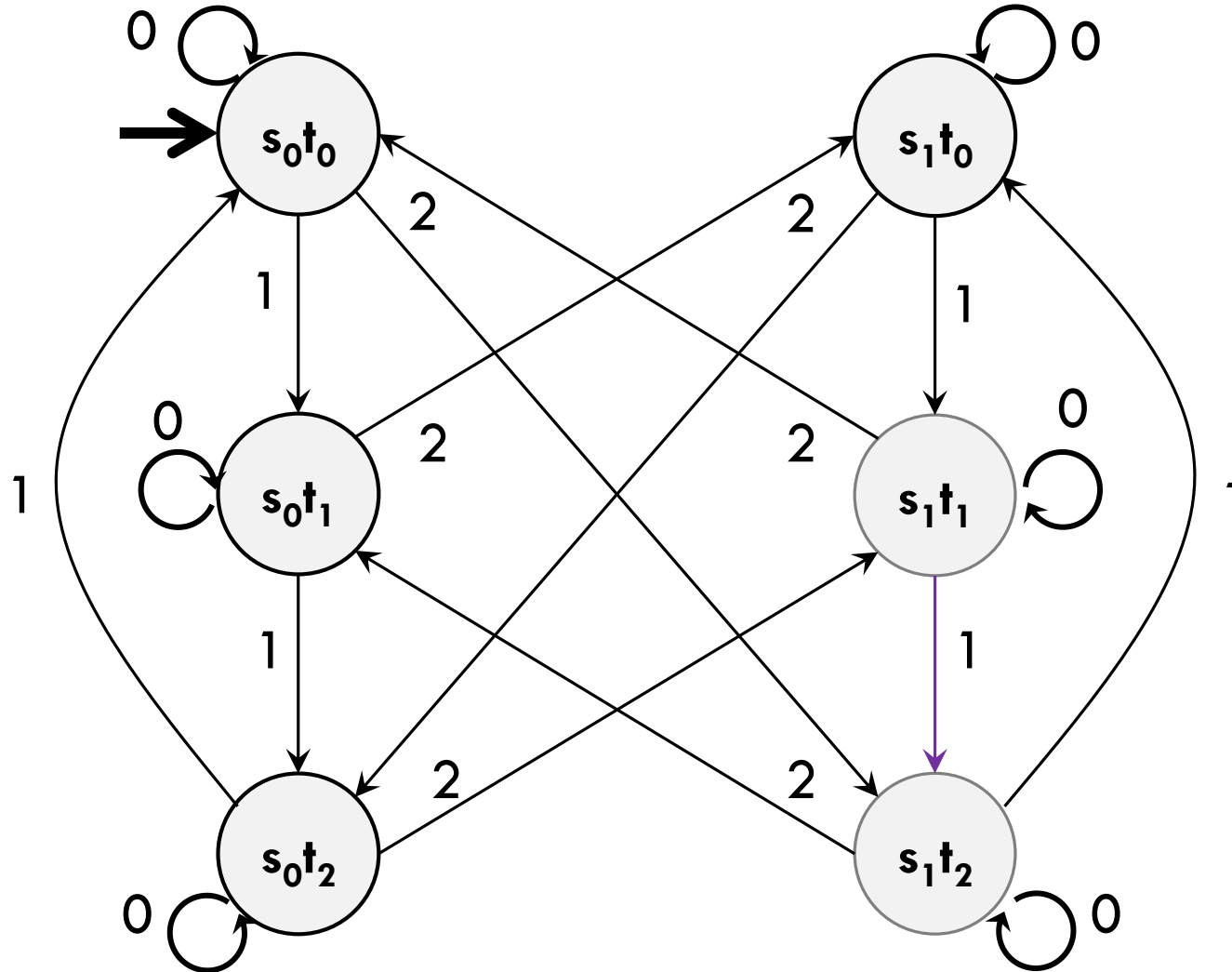

Strings over $\{0,1,2\}$ w/ even number of 2's **OR** $\text{sum} \% 3 = 0$

Want to change the and to or – don't need to change states or transitions... Just which accept.

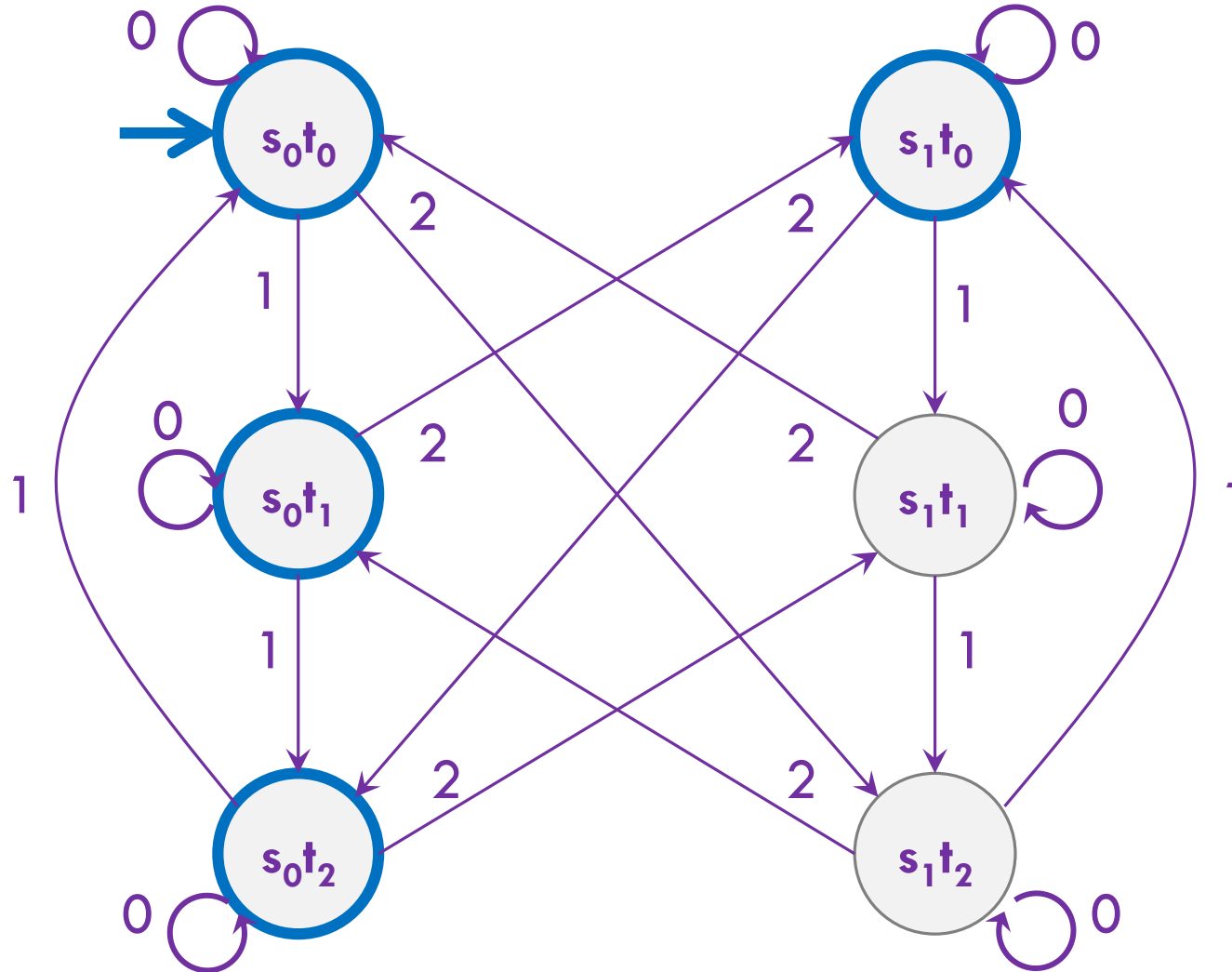

The set of binary strings with a 1 in the 3rd position from the start

The set of binary strings with a 1 in the 3rd position from the start

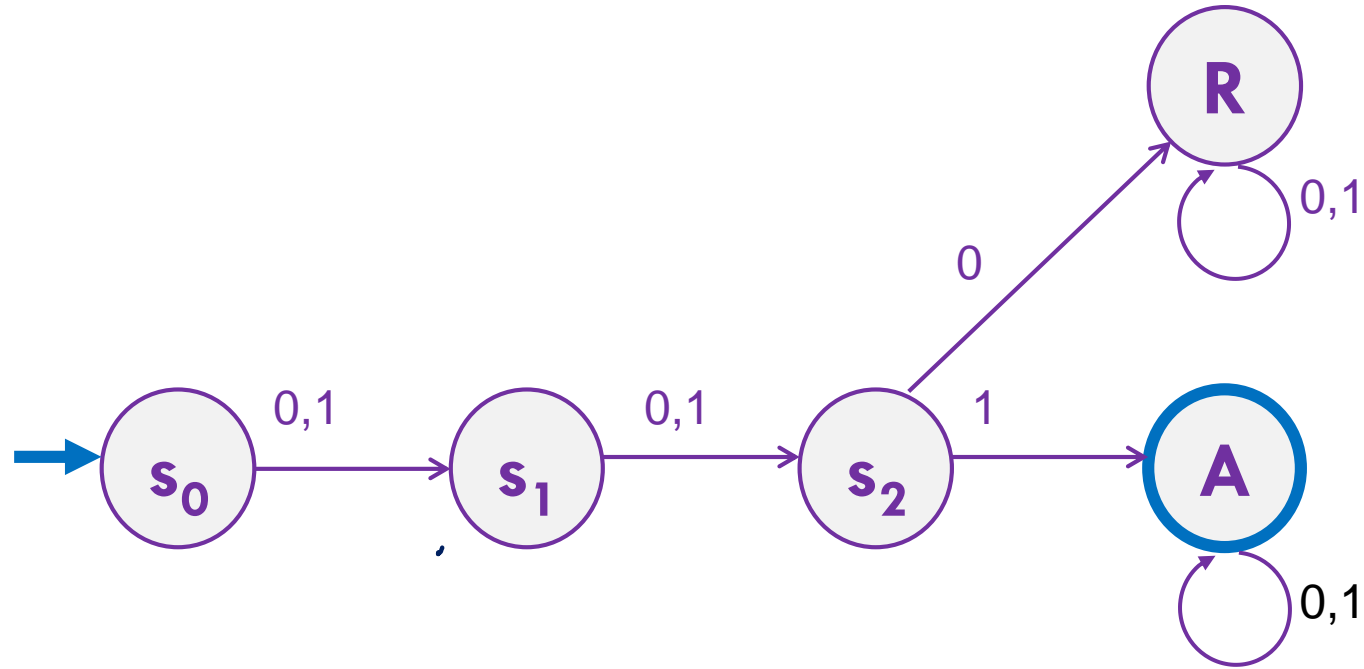

The set of binary strings with a 1 in the 3rd position from the end

What do we need to remember?

We can't know what string was third from the end until we have read the last character.

So we'll need to keep track of "the character that was 3 ago" in case this was the end of the string.

But if it's not...we'll need the character 2 ago, to update what the character 3 ago becomes. Same with the last character.

3 bit shift register “Remember the last three bits”

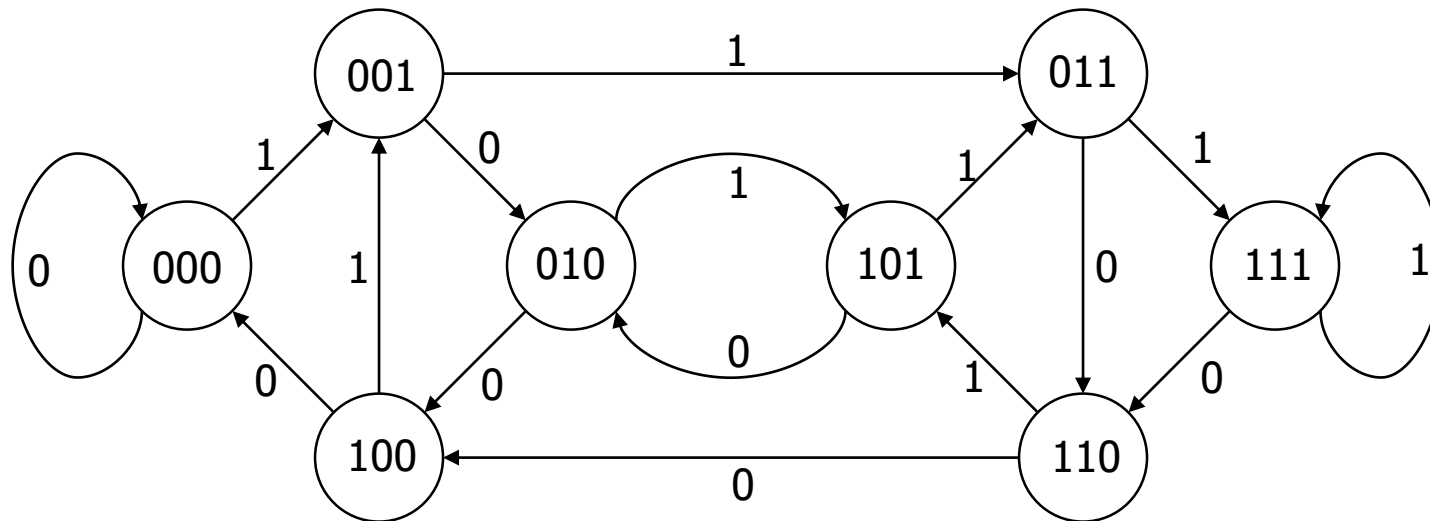

The set of binary strings with a 1 in the 3rd position from the end

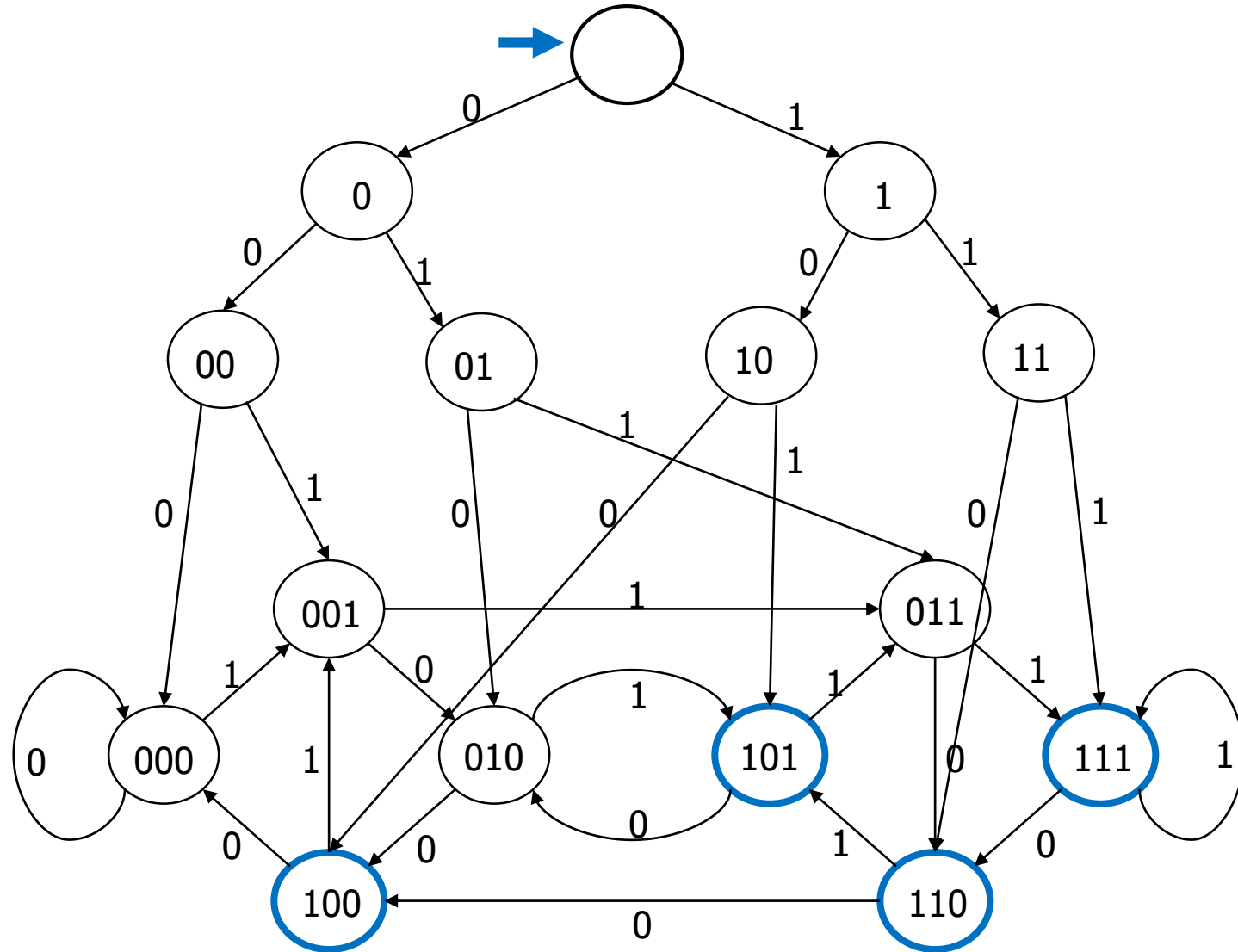

The set of binary strings with a 1 in the 3rd position from the end

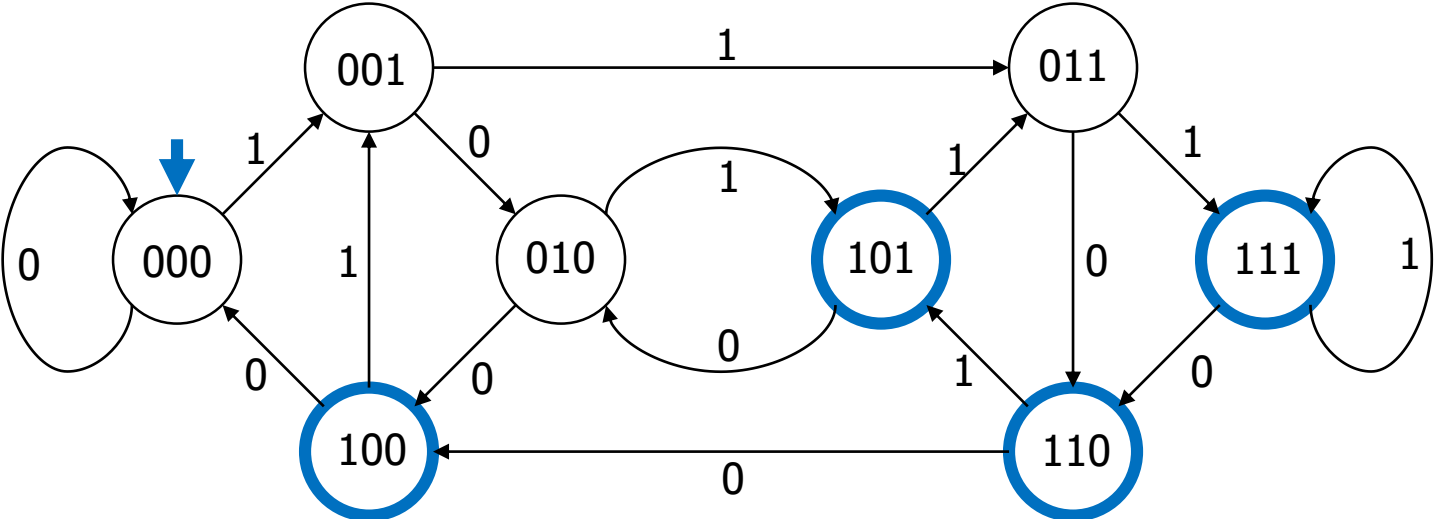

The beginning versus the end

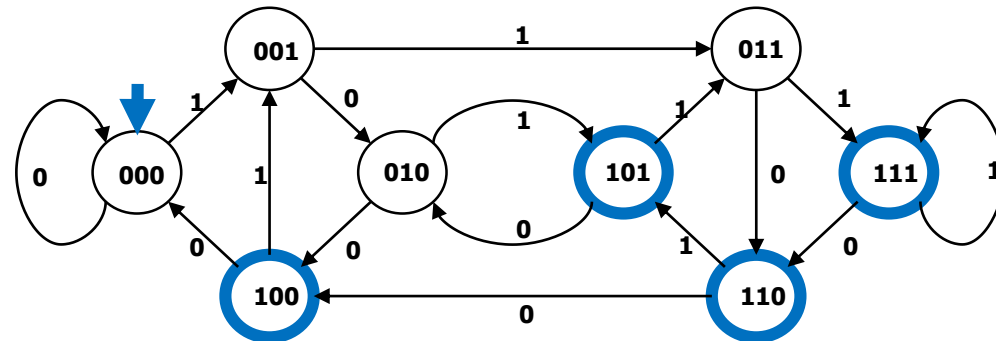
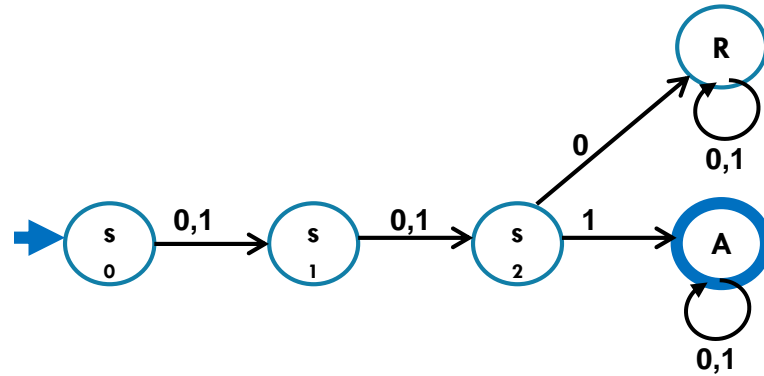

From the beginning was “easier” than “from the end”

At least in the sense that we needed fewer states.

That might be surprising since a java program wouldn't be much different for those two.

Not being able to access the full input at once limits your abilities somewhat and makes some jobs harder than others.

What language does this machine recognize?

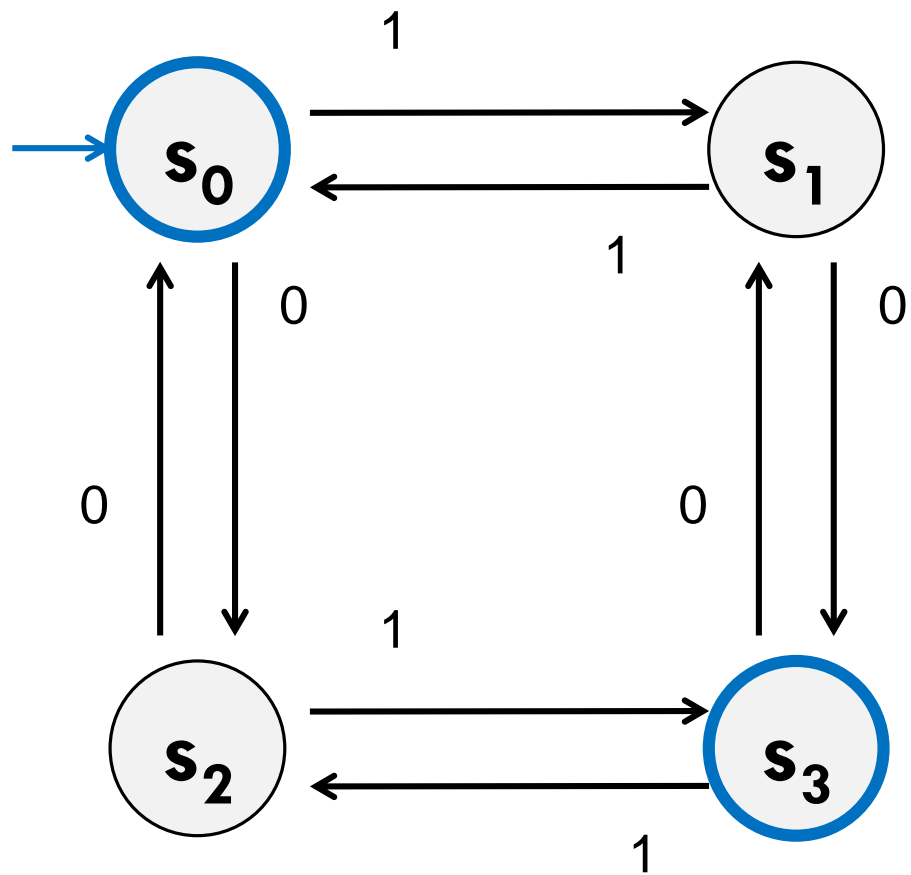

What language does this machine recognize?

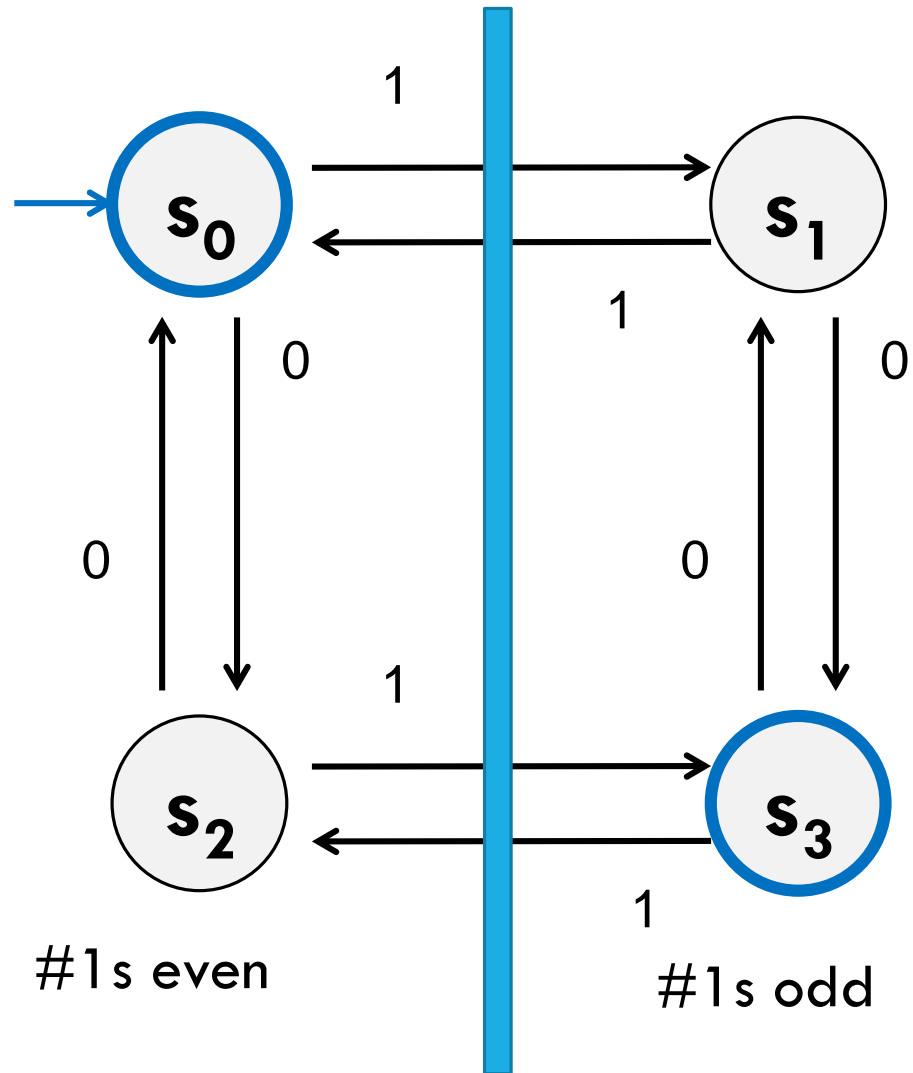

What language does this machine recognize?

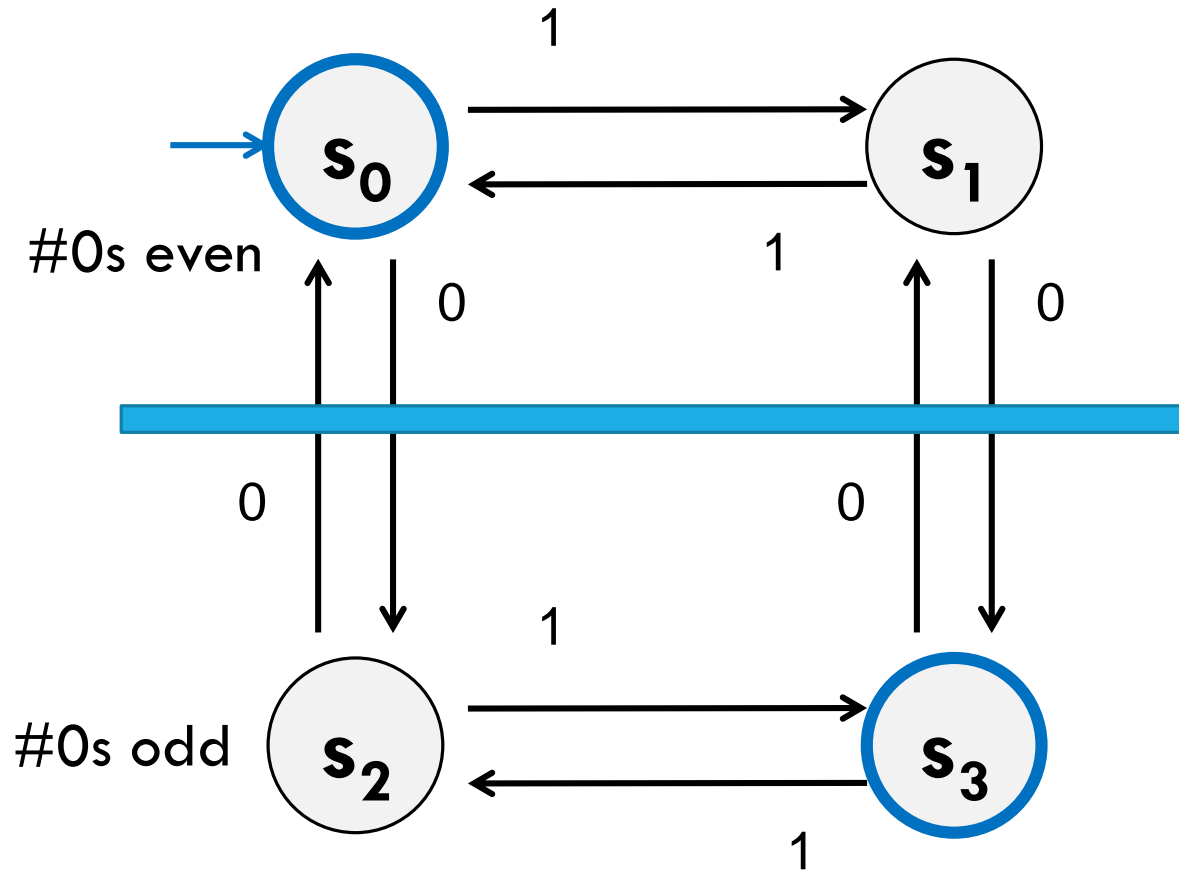

What language does this machine recognize?

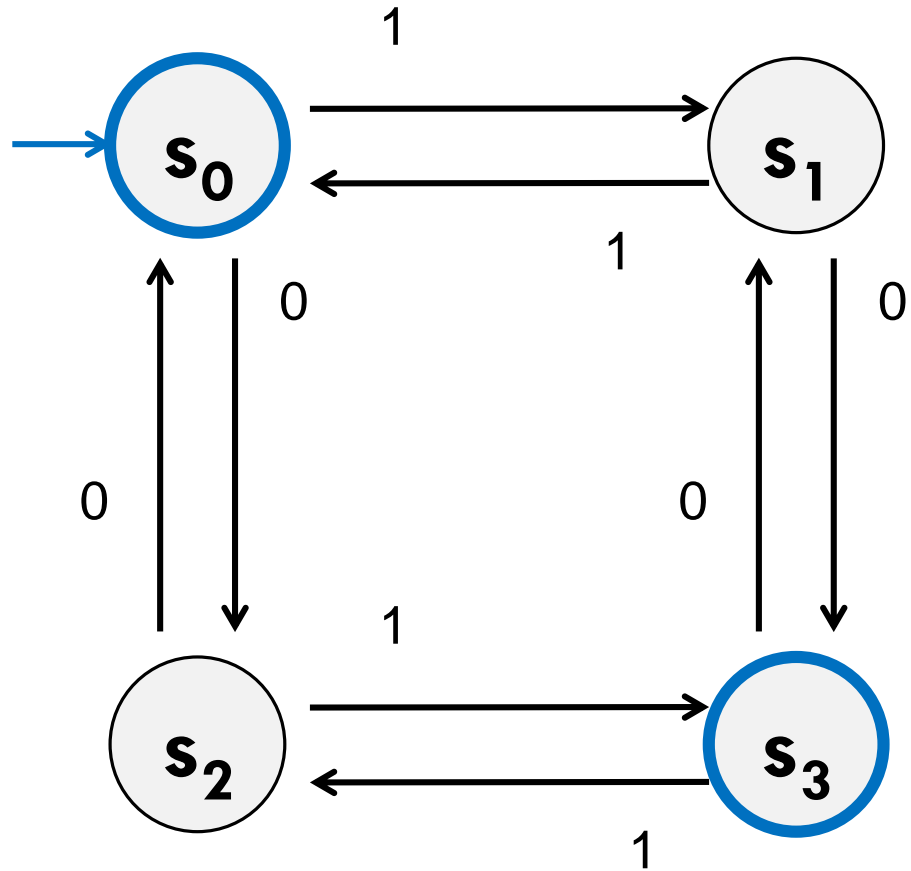

#0s is congruent to #1s (mod 2)

Wait...there's an easier way to describe that....

What language does this machine recognize?

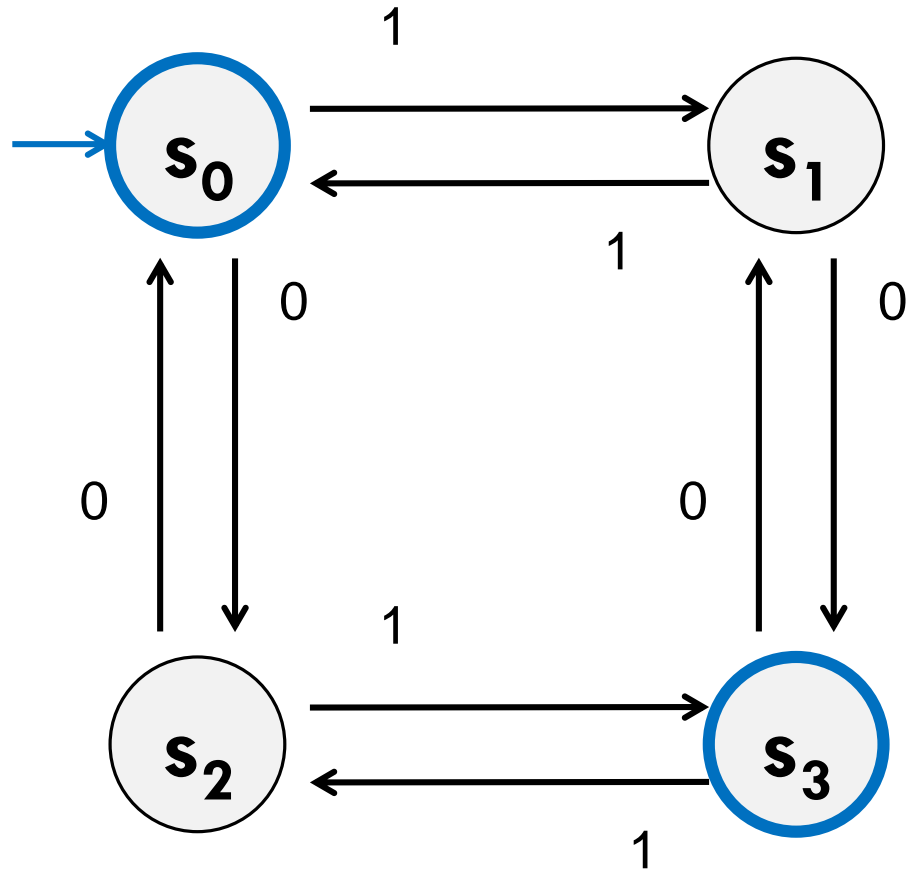

That's all binary strings of even length.

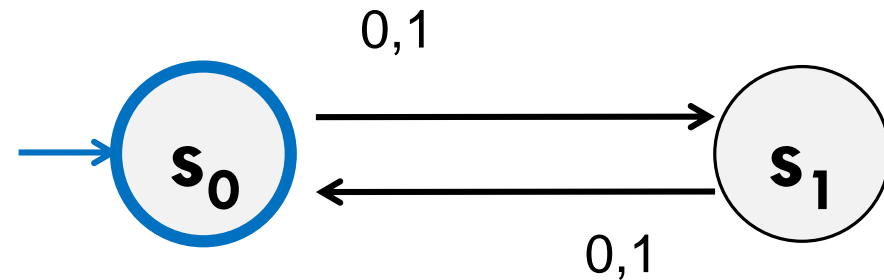

Takeaways

The first DFA might not be the simplest.

Try to think of other descriptions – you might realize you can keep track of fewer things than you thought.

Boy...it'd be nice if we could know that we have the smallest possible DFA for a given language...

DFA Minimization

We can know!

Fun fact: there is a **unique** minimum DFA for every language (up to renaming the states)

High level idea – final states and non-final states must be different.

Otherwise, hope that states can be the same, and iteratively separate when they have to go to different spots.

In some quarters, we cover it in detail. But...we ran out of time.

Optional slides will be posted – won't be required in HW or final but you might find it useful/interesting for your own learning.

Next Time

Some (historic and modern) applications of DFAs

There are some languages DFAs can't recognize (say, $\{0^k 1^k \mid k \geq 0\}$)

What if we give the DFAs a little more power...try to get them to do more things.