

# CSE 333

## Lecture 16 -- networks

**Hal Perkins**

Department of Computer Science & Engineering

University of Washington





# Administrivia

HW3 due Thursday night

- No exercises until after that
- But with the long weekend coming up, maybe two due right afterwards? (Tuesday morning instead of Monday, then Wed.)

HW4 out by end of the week



# Networks from 10,000ft

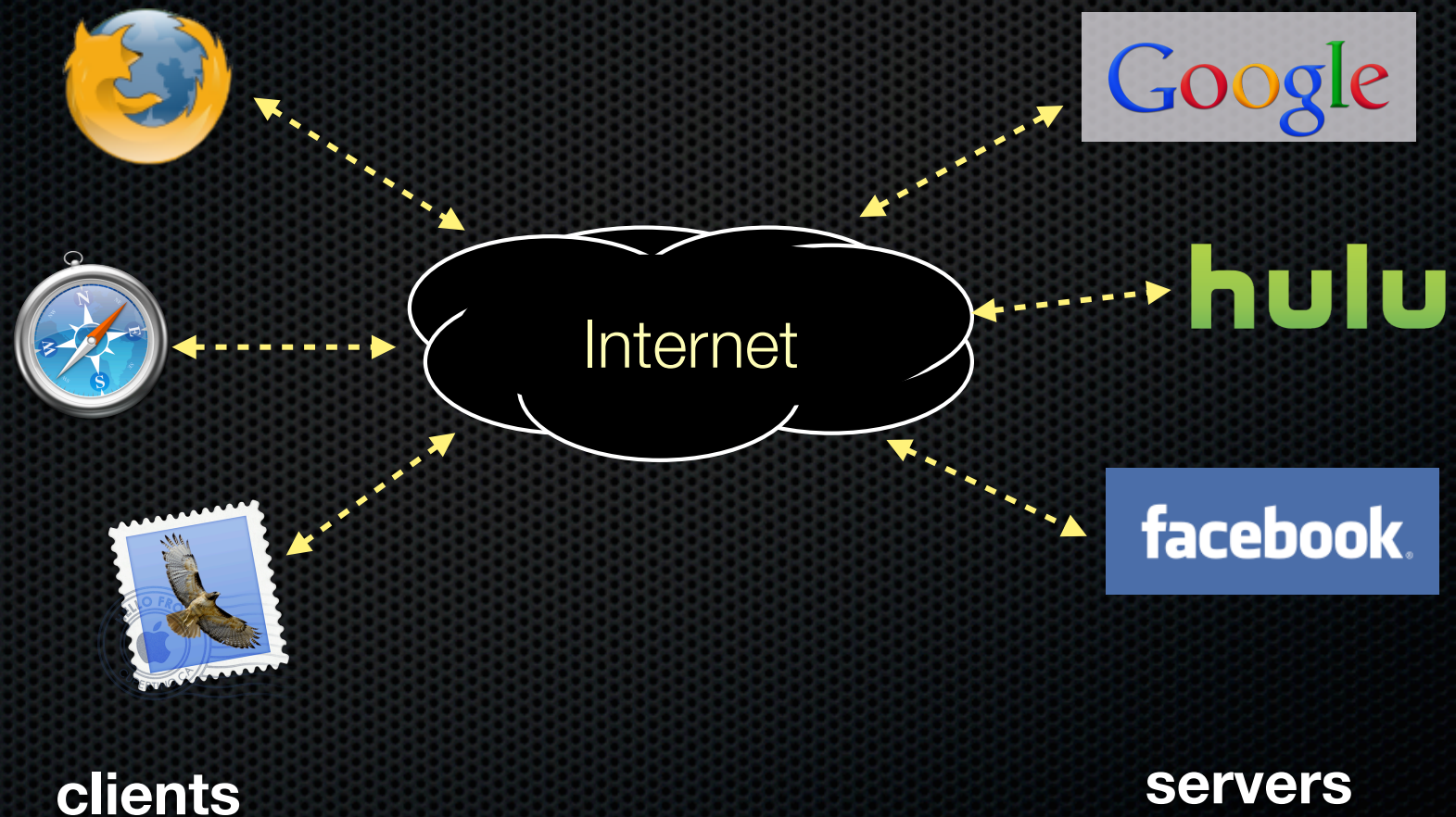



# The “physical” layer

Individual bits are modulated onto a wire or transmitted over radio

- ▶ physical layer specifies how bits are encoded at a signal level
- ▶ e.g., a simple spec would encode “1” as +1V, “0” as -1V

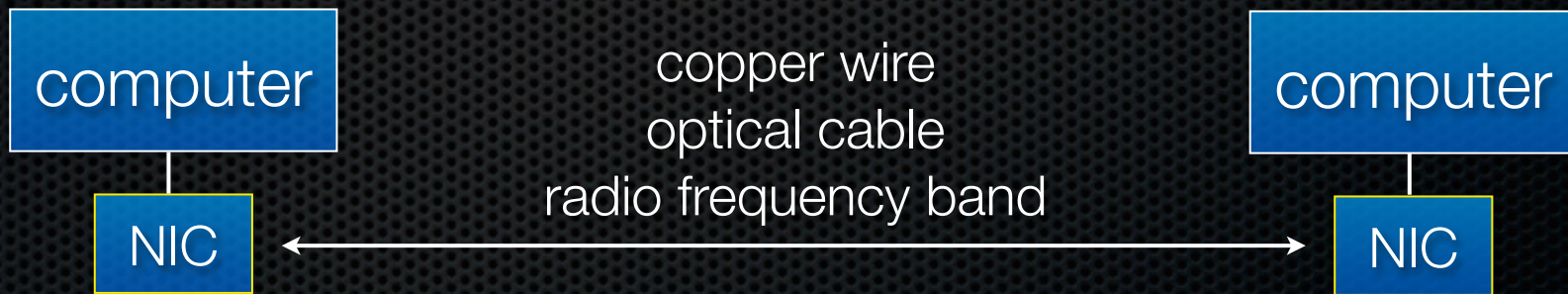
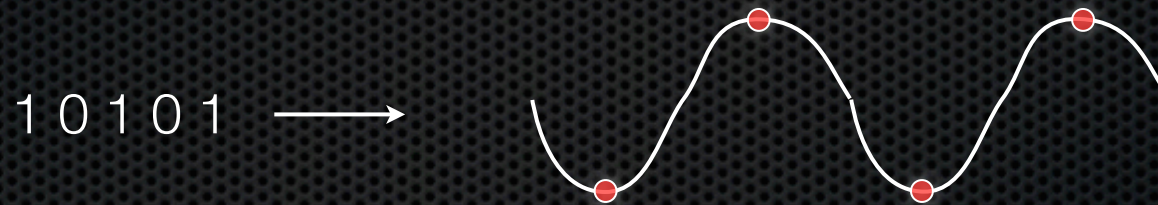



# The “data link” layer

Multiple computers on a LAN contend for the network medium

- ▶ media access control (MAC) specifies how computers cooperate
- ▶ link layer also specifies how bits are packetized and NICs are addressed

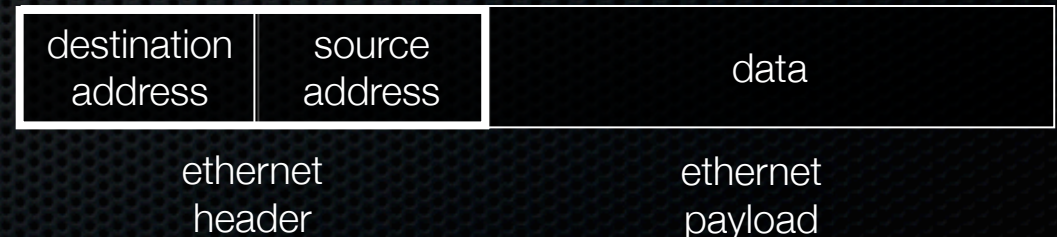
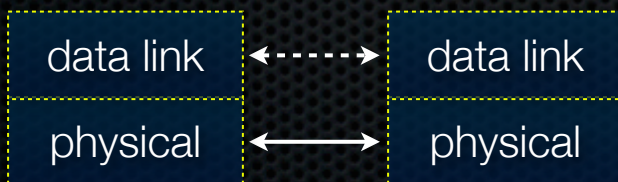
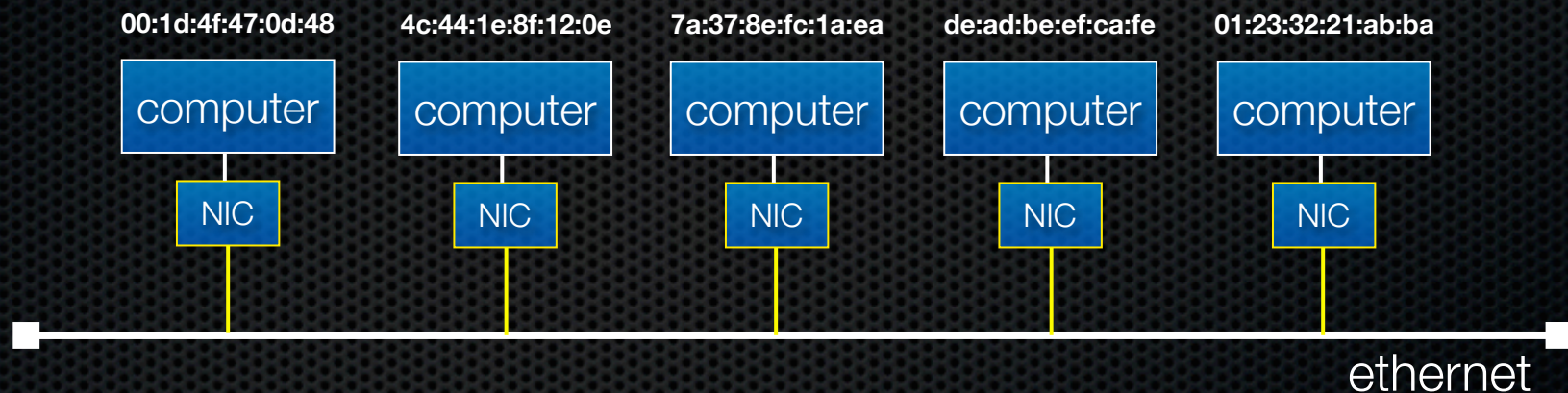



# The “network” layer (IP)

The Internet Protocol (IP) routes packets across multiple networks

- ▶ every computer has a unique Internet address (IP address)
- ▶ individual networks are connected by routers that span networks

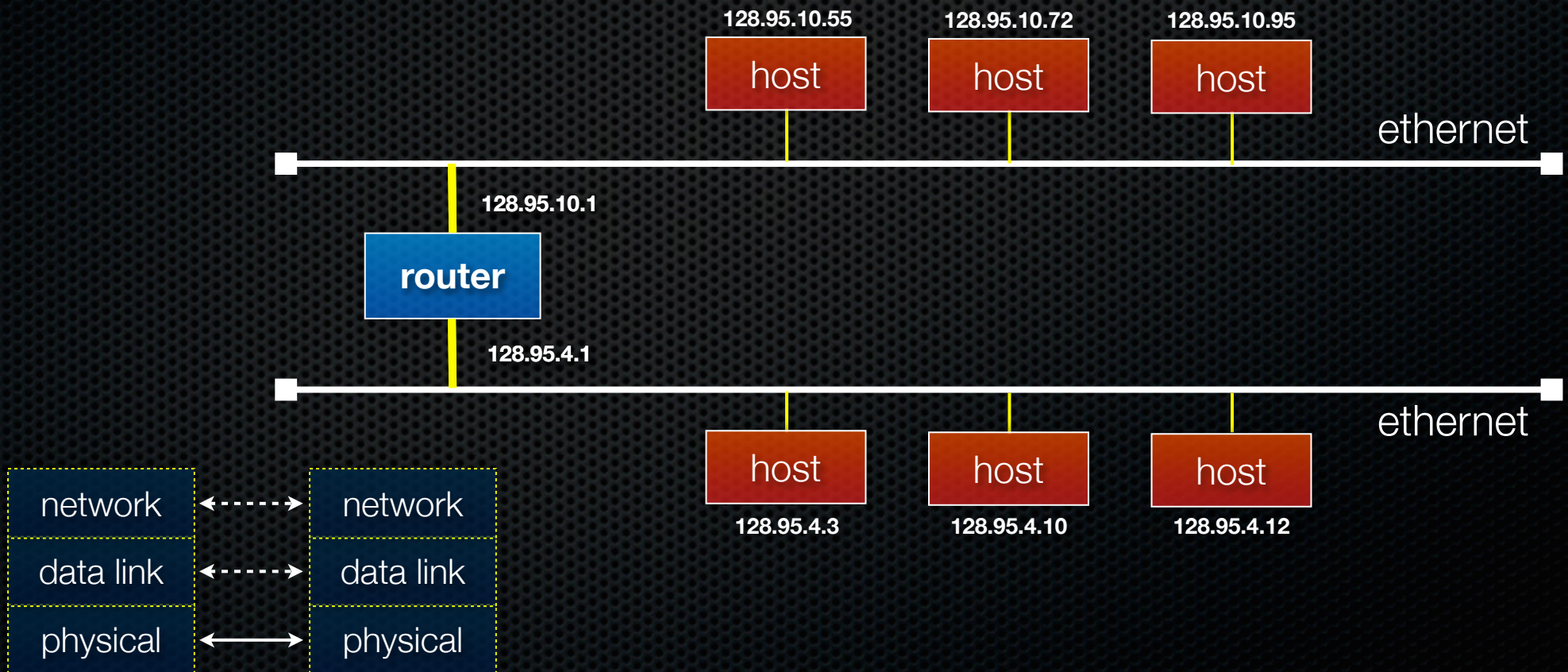



# The “network” layer (IP)

Protocols to:

- ▶ let a host find the MAC address of an IP address on the same network
- ▶ let a router learn about other routers and figure out how to get IP packets one step closer to their destination

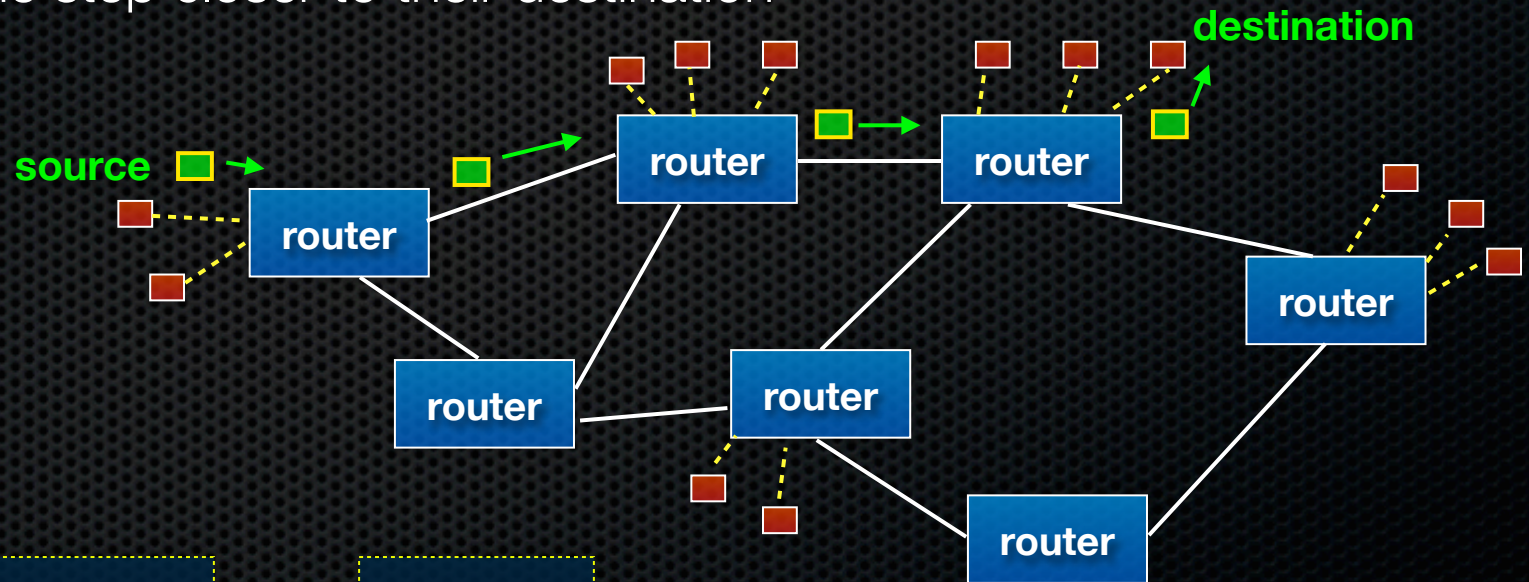



# The “network” layer (IP)

## Packet encapsulation

- ▶ an IP packet is encapsulated as the payload of an Ethernet frame
- ▶ as IP packets traverse networks, routers pull out the IP packet from an ethernet frame and plunk it into a new one on the next network

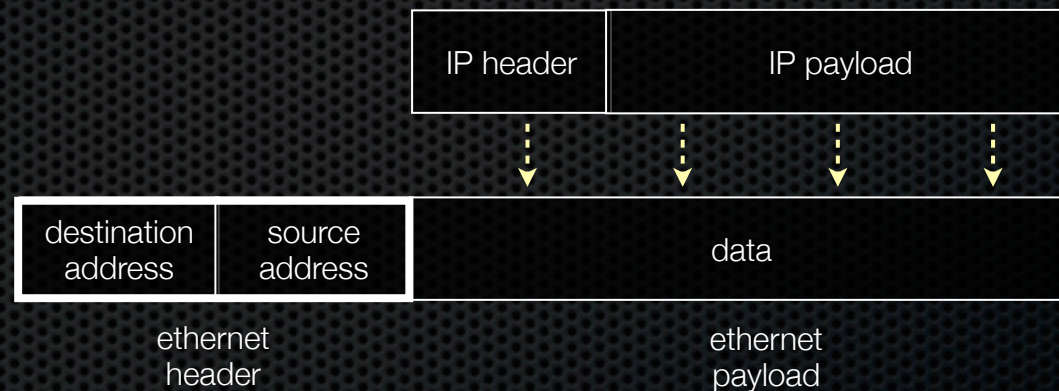



# The “transport” layer (TCP, UDP)

## TCP

- ▶ the “transmission control protocol”
- ▶ provides apps with reliable, ordered, congestion-controlled byte streams
- ▶ fabricates them by sending multiple IP packets, using sequence numbers to detect missing packets, and retransmitting them
- ▶ a single host (IP address) can have up to 65,535 “ports”
  - ▶ kind of like an apartment number at a postal address

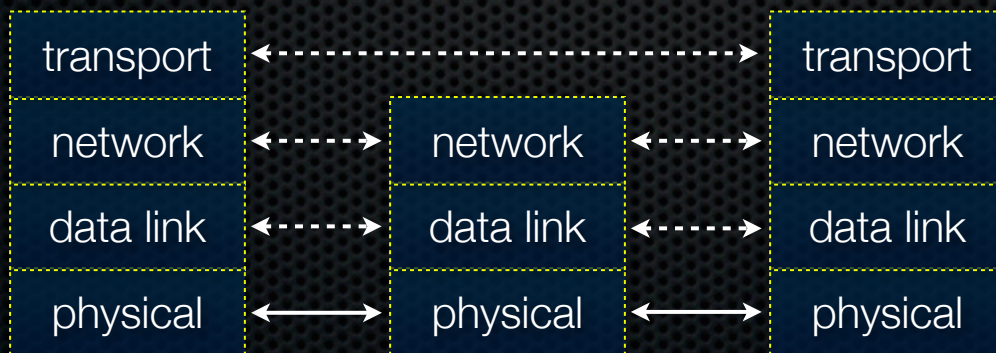



# The “transport” layer (TCP, UDP)

## TCP

- ▶ useful analogy: how would you send a book by mail via postcards?
- ▶ split the book into multiple postcards, send each one by one, including sequence numbers that indicate the assembly order
- ▶ receiver sends back postcards to acknowledge receipt and indicate which got lost in the mail

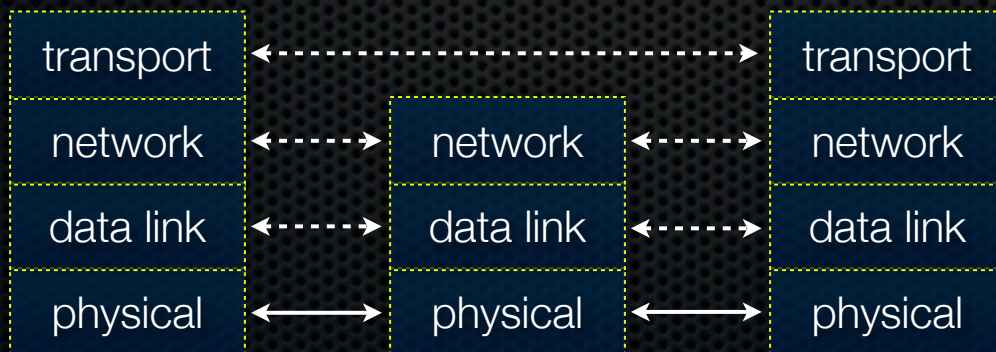



# The “transport” layer (TCP)

Packet encapsulation -- same as before!

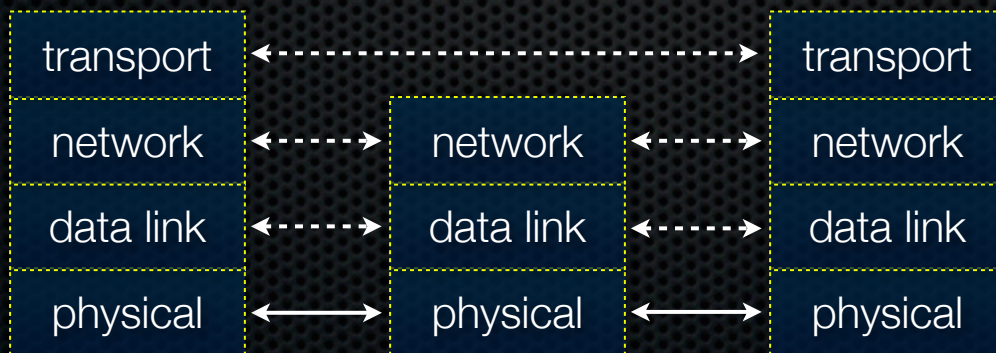
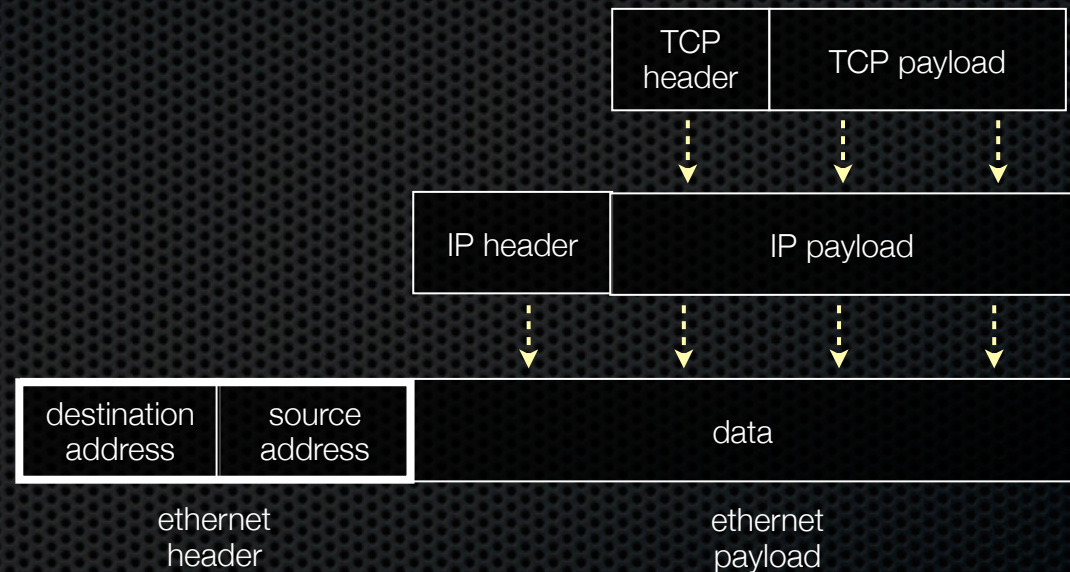



# The “transport” layer (TCP)

Applications use OS services to establish TCP streams

- ▶ the “Berkeley sockets” API -- a set of OS system calls
- ▶ clients **connect()** to a server IP address + application port number
- ▶ servers **listen()** for and **accept()** client connections
- ▶ clients, servers **read()** and **write()** data to each other

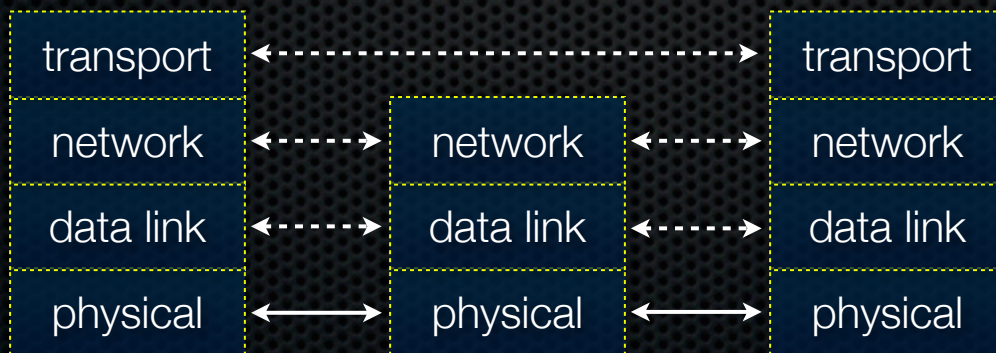



# The “transport” layer (UDP)

## UDP

- the “user datagram protocol”
- provides apps with unreliable packet delivery
- UDP datagrams are fragmented into multiple IP packets
  - UDP is a really thin, simple layer on top of IP

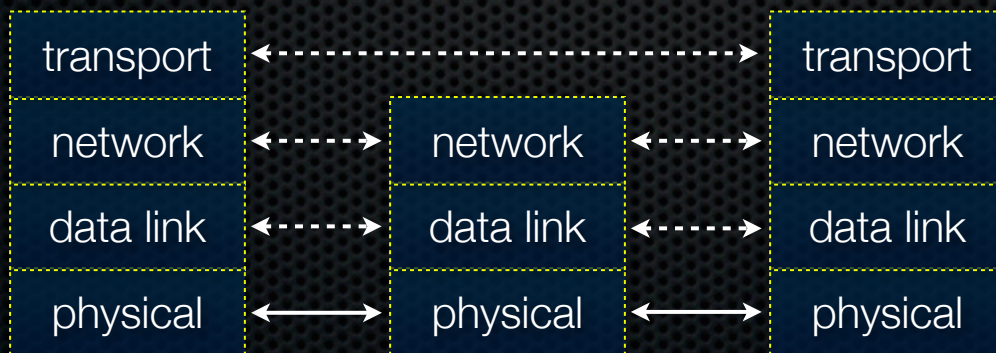



# The (mostly missing) layers 5,6

## Layer 5: session layer

- ▶ supposedly handles establishing, terminating application sessions
- ▶ RPC kind of fits in here

## Layer 6: presentation layer

- ▶ supposedly maps application-specific data units into a more network-neutral representation
- ▶ encryption (SSL) kind of fits in here

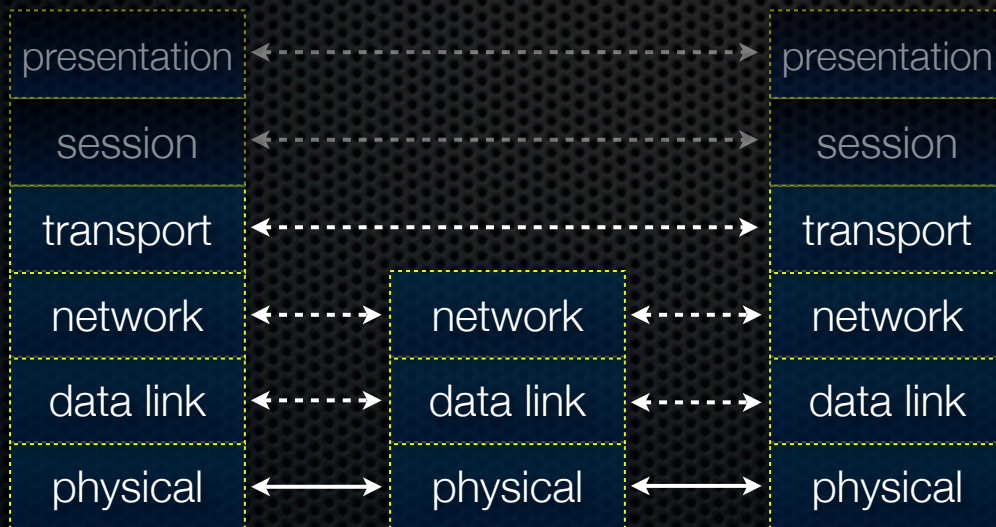



# The “application” layer

## Application protocols

- the format and meaning of messages between application entities
- e.g., HTTP is an application level protocol that dictates how web browsers and web servers communicate
  - ▶ HTTP is implemented on top of TCP streams

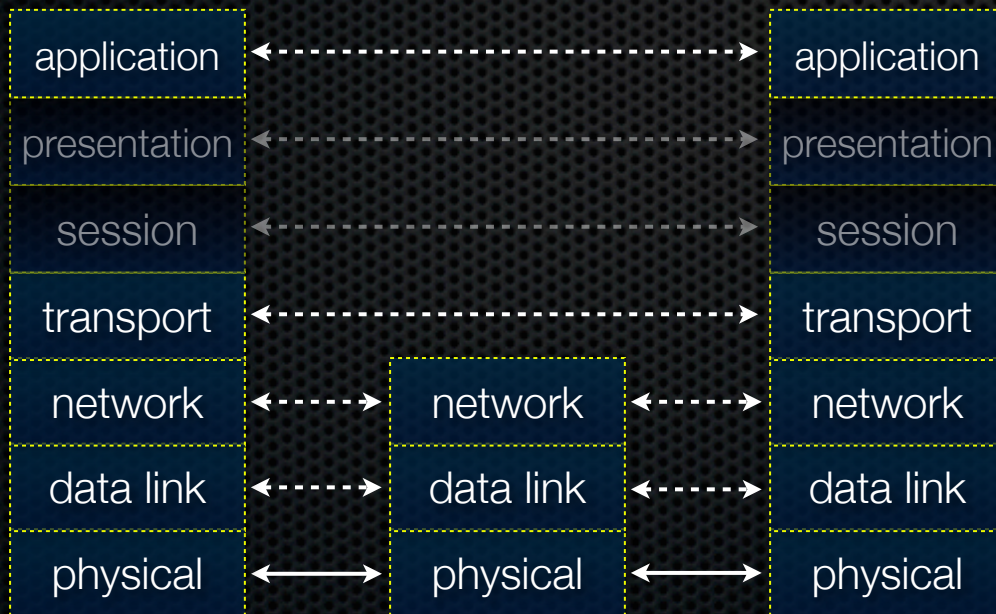



# The “application” layer

Packet encapsulation -- same as before!

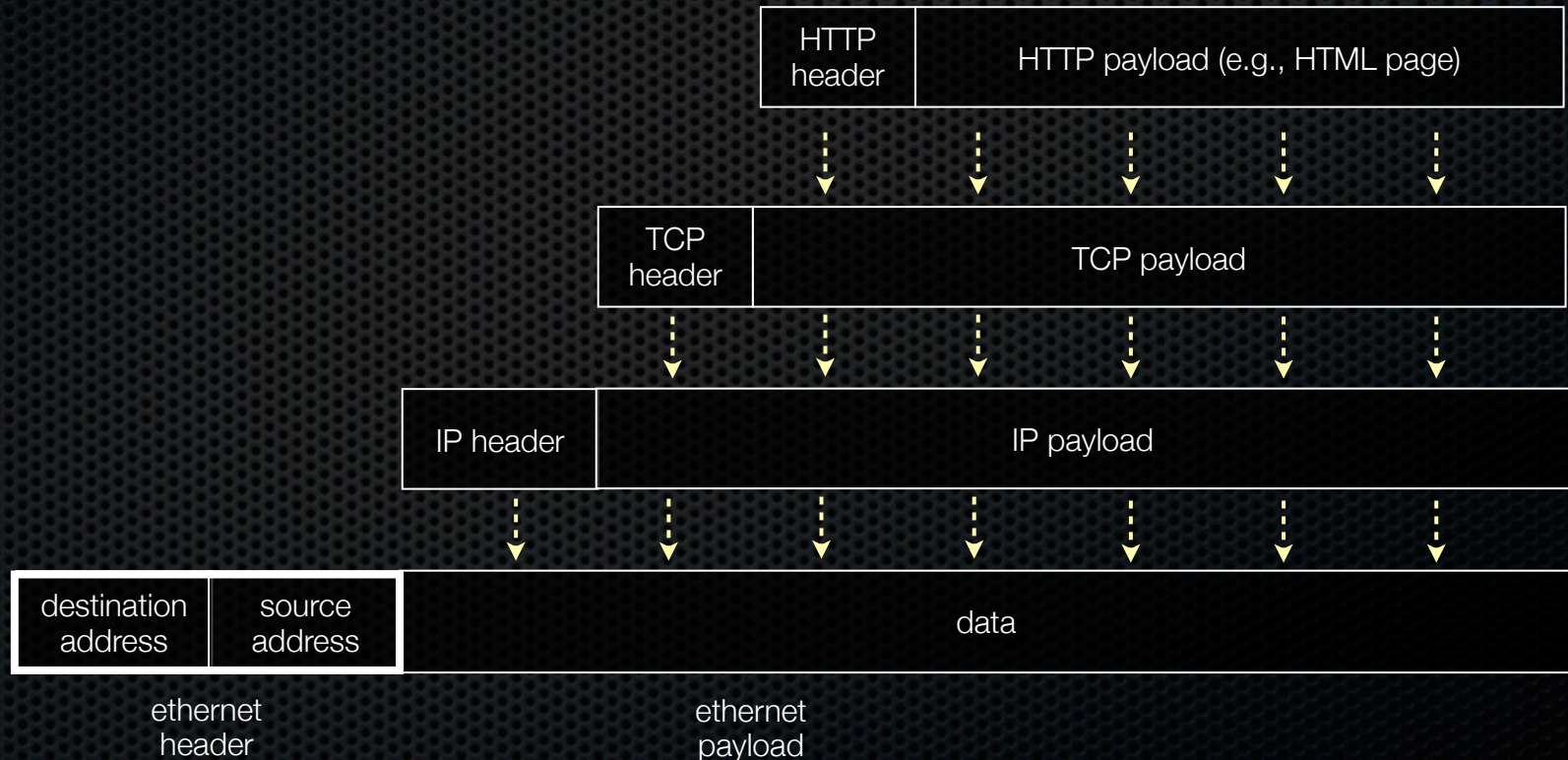



# The “application” layer

Packet encapsulation -- same as before!

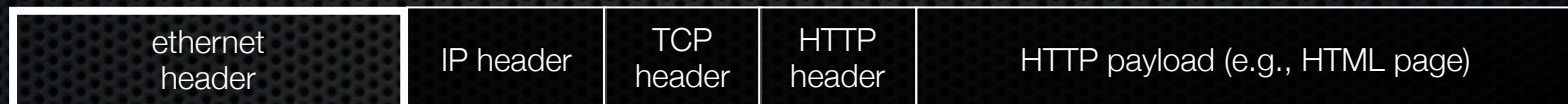



# The “application” layer

## Popular application-level protocols:

- **DNS**: translates a DNS name (**www.google.com**) into one or more IP addresses (74.125.155.105, 74.125.155.106, ...)
  - a hierarchy of DNS servers cooperate to do this
- **HTTP**: web protocols
- **SMTP, IMAP, POP**: mail delivery and access protocols
- **ssh**: remote login protocol
- **bittorrent**: peer-to-peer, swarming file sharing protocol



See you on Wednesday!