

CSE 333

Lecture 21 -- fork, pthread_create

Hal Perkins

Department of Computer Science & Engineering

University of Washington



Administrivia

HW4 is due Wednesday night

<panic> if you haven't started yet **</panic>**

Usual late days apply *if* you have any left

pthreads exercise due Monday before class

Second exam last day of class, next Friday

Overview/review in section next week

Topic list and old exams on web now

Some common HW4 bugs

Your server works, but is really really slow

check the 2nd argument to the `QueryProcessor` constructor

Funny things happen after the first request

make sure you're not destroying the `HTTPConnection` object too early (e.g., falling out of scope in a while loop)

Server crashes on blank request

make sure you handle the case that `read()` [or `WrappedRead`] returns 0

Previously

We implemented hw3 searchserver, but it was sequential

it processed requests one at a time, in spite of client interactions blocking for arbitrarily long periods of time

this led to terrible performance

Servers should be concurrent

process multiple requests simultaneously

issue multiple I/O requests simultaneously

overlap the I/O of one request with computation of another

utilize multiple CPUs / cores

Today

We'll go over three versions of searchserver

sequential

concurrent

processes [**fork()**]

threads [**pthread_create()**]

Alternative (which we won't get to): non-blocking, event driven version

non-blocking I/O [**select()**]

Reference: *Computer Systems: A Programmer's Perspective*

351 textbook, good source for process/thread/OS ideas

Sequential

pseudocode:

```
listen_fd = Listen(port);  
  
while(1) {  
    client_fd = accept(listen_fd);  
    buf = read(client_fd);  
    resp = ProcessQuery(buf);  
    write(client_fd, resp);  
    close(client_fd);  
}
```

*look at **searchserver_sequential/***

Whither sequential?

Benefits

- super simple to build

Disadvantages

- incredibly poorly performing

 - one slow client causes **all** others to block

 - poor utilization of network, CPU

fork()

```
pid_t fork(void);
```

Fork is used to create a new process (the “child”) that is an exact clone of the current process (the “parent”)

everything is cloned (except threads)

all variables, file descriptors, open sockets, etc.

the heap, the stack, etc.

primarily used in two patterns

servers: fork a child to handle a connection

shells: fork a child, which then exec’s a new program

fork() and address spaces

Remember this picture...?

a process executes within an
address space

the address space includes:

a stack (for stack frames)

heap (for dynamically allocated data)

text segment (containing code)

etc.

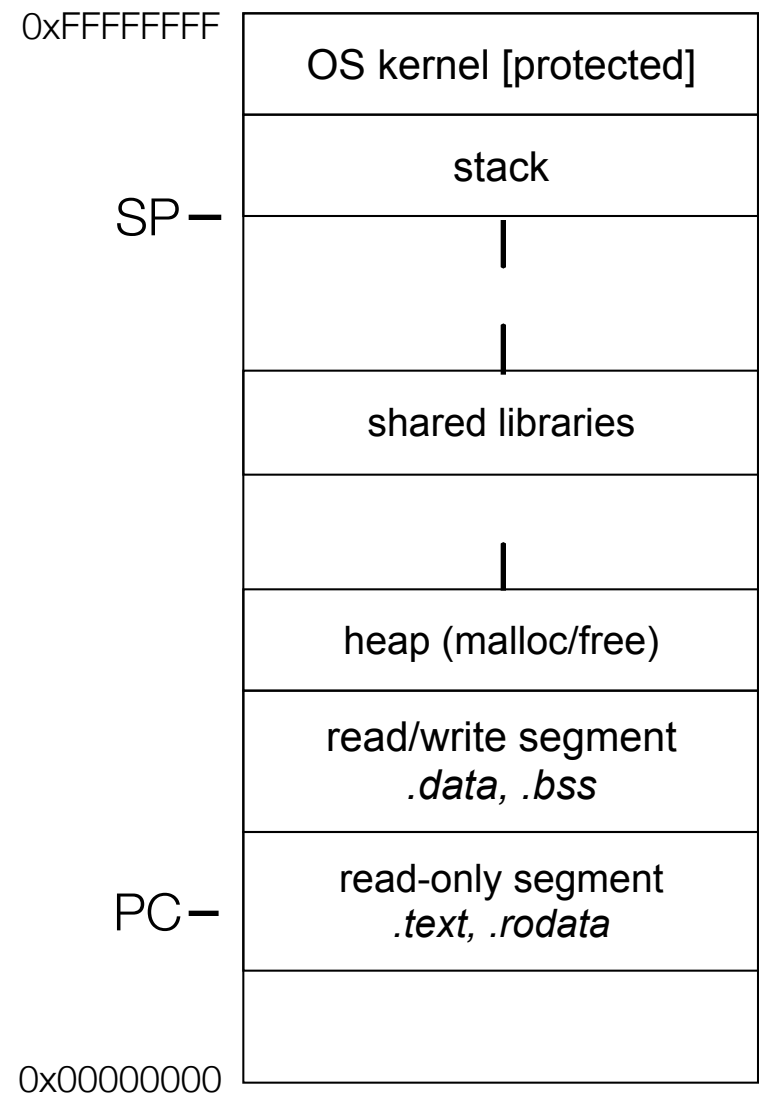

fork() and address spaces

Fork causes the OS to clone the address space, creating a brand new process

the new process starts life as a **copy** the old process in (nearly) every way

the **copies** of the heap, stack, text segment, etc. are (nearly) identical

the new process has **copies** of the parent's data structures, stack-allocated variables, open file descriptors, and so on

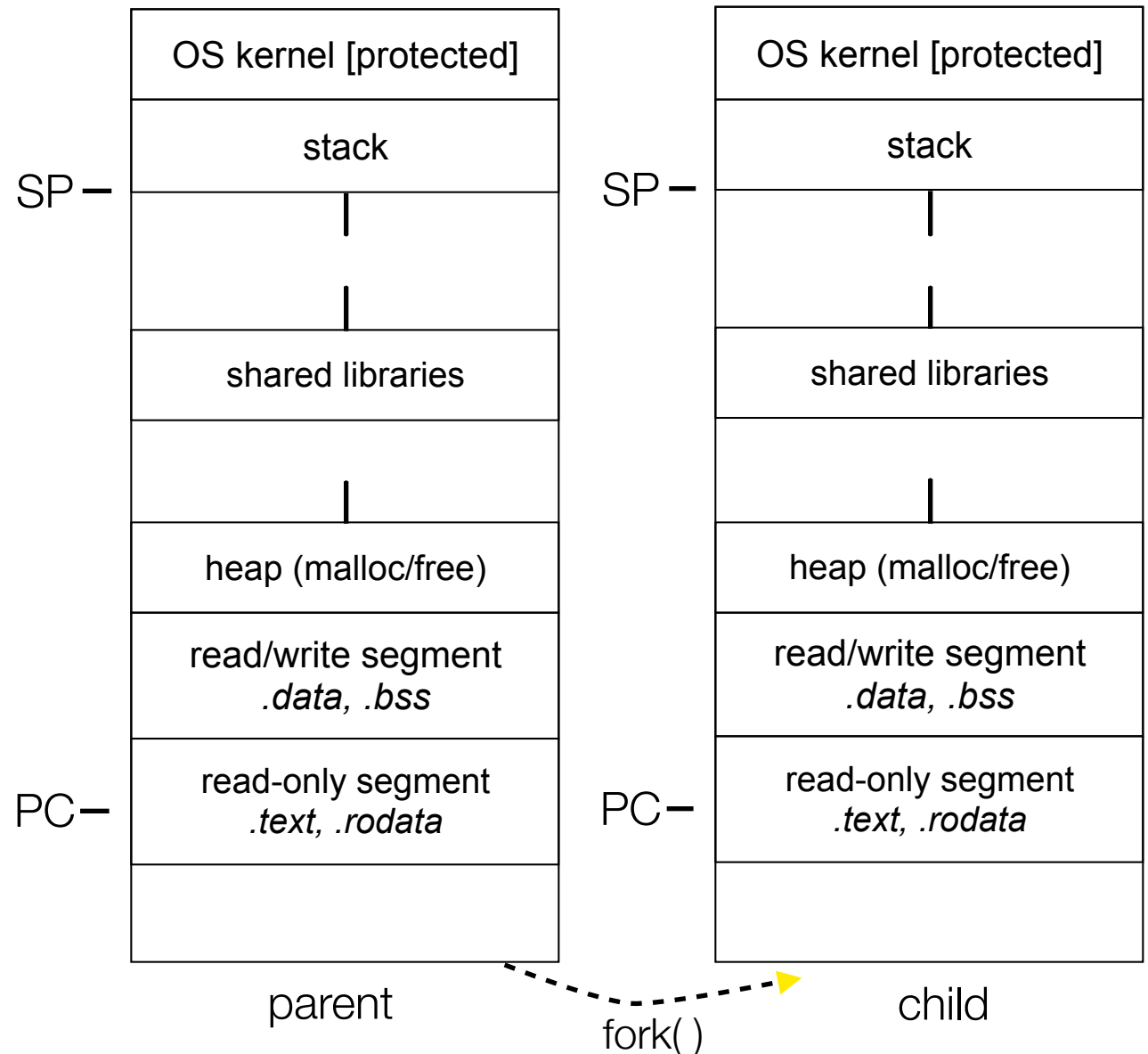

fork()

fork() has peculiar semantics

the parent invokes fork()

the operating system clones
the parent

both the parent and the child
return from fork

parent receives child's pid

child receives a "0" as pid

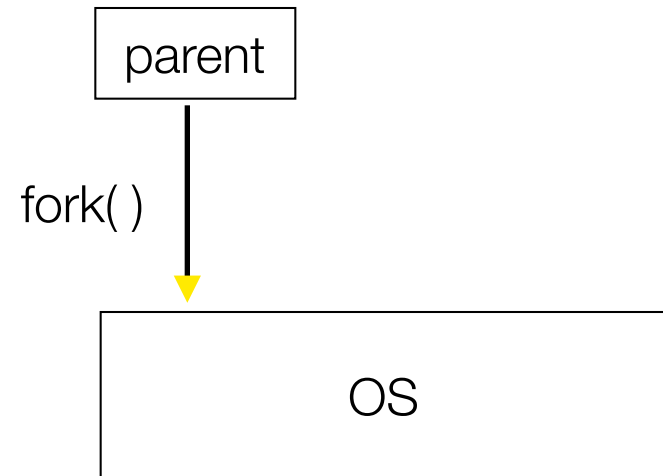

fork()

fork() has peculiar semantics

the parent invokes fork()

the operating system clones
the parent

both the parent and the child
return from fork

parent receives child's pid

child receives a "0" as pid

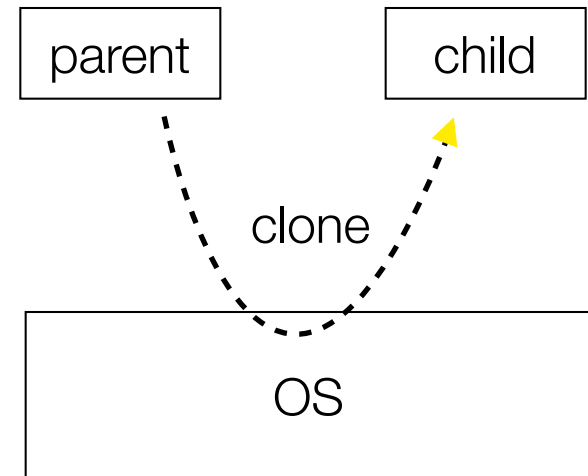

fork()

fork() has peculiar semantics

the parent invokes fork()

the operating system clones
the parent

both the parent and the child
return from fork

parent receives child's pid

child receives a "0" as pid

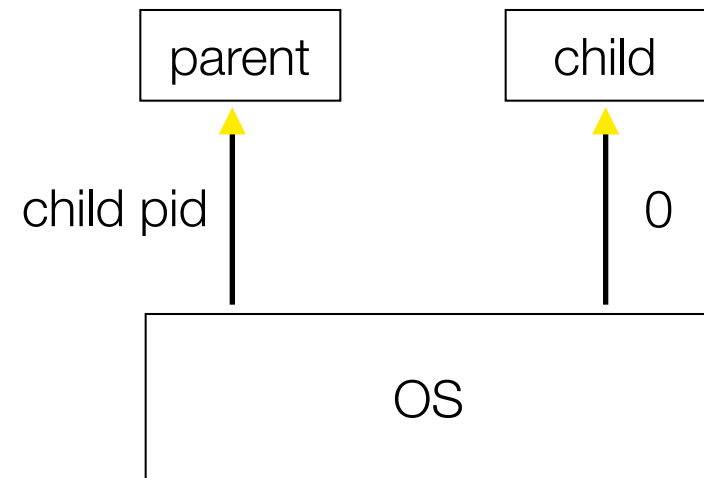

fork()

fork_example.cc

Concurrency with processes

The **parent** process blocks on **accept()**, waiting for a new client to connect

when a new connection arrives, the parent calls **fork()** to create a **child** process

the child process handles that new connection, and **exit()**'s when the connection terminates

Remember that children become “zombies” after death

option a) parent calls **wait()** to “reap” children

option b) use the double-fork trick

Graphically



Graphically

client —

— server

Graphically

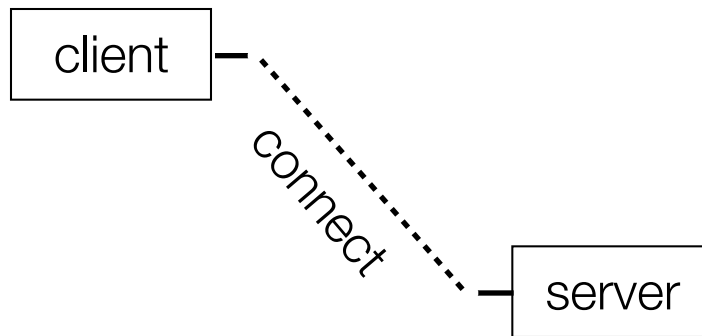

Graphically

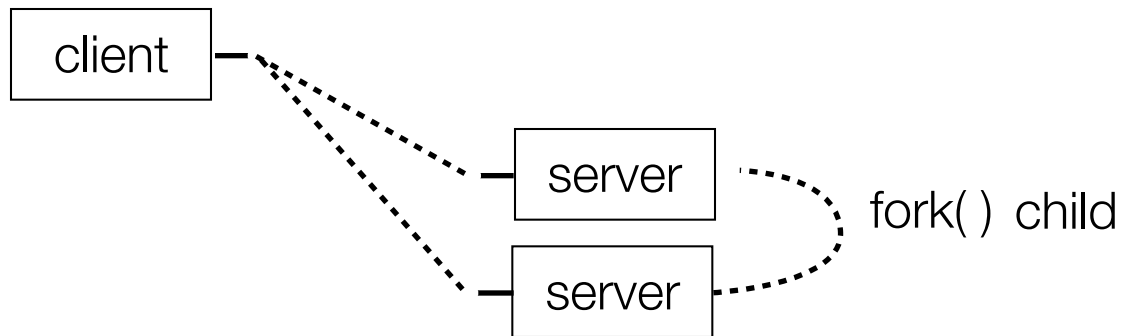

Graphically

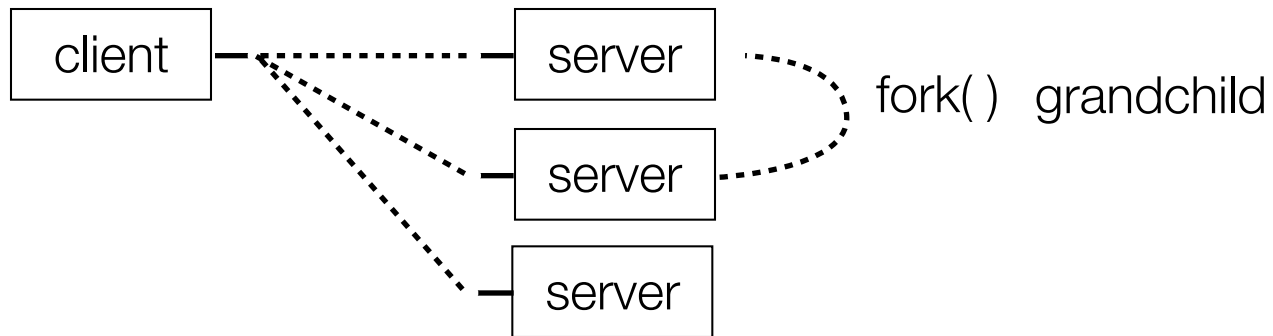

Graphically

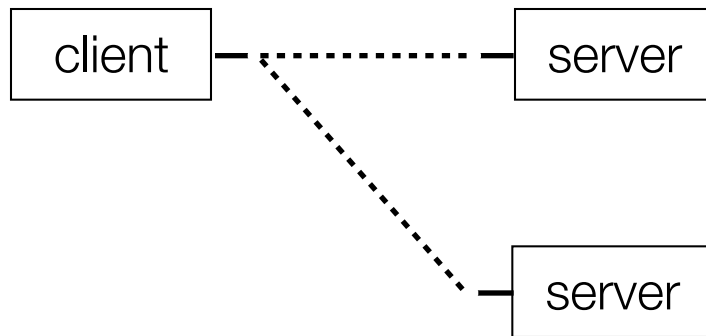

child `exit()`'s / parent `wait()`'s

Graphically



Graphically

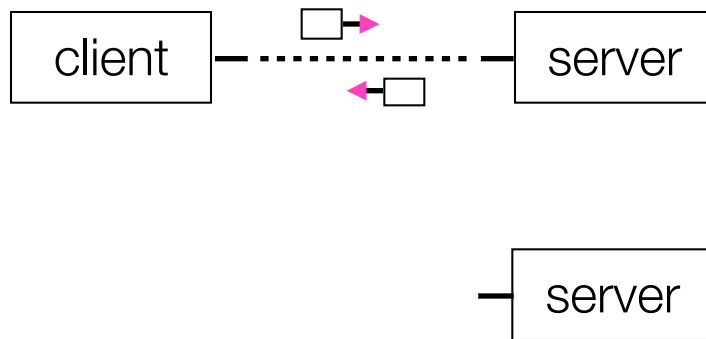

Graphically

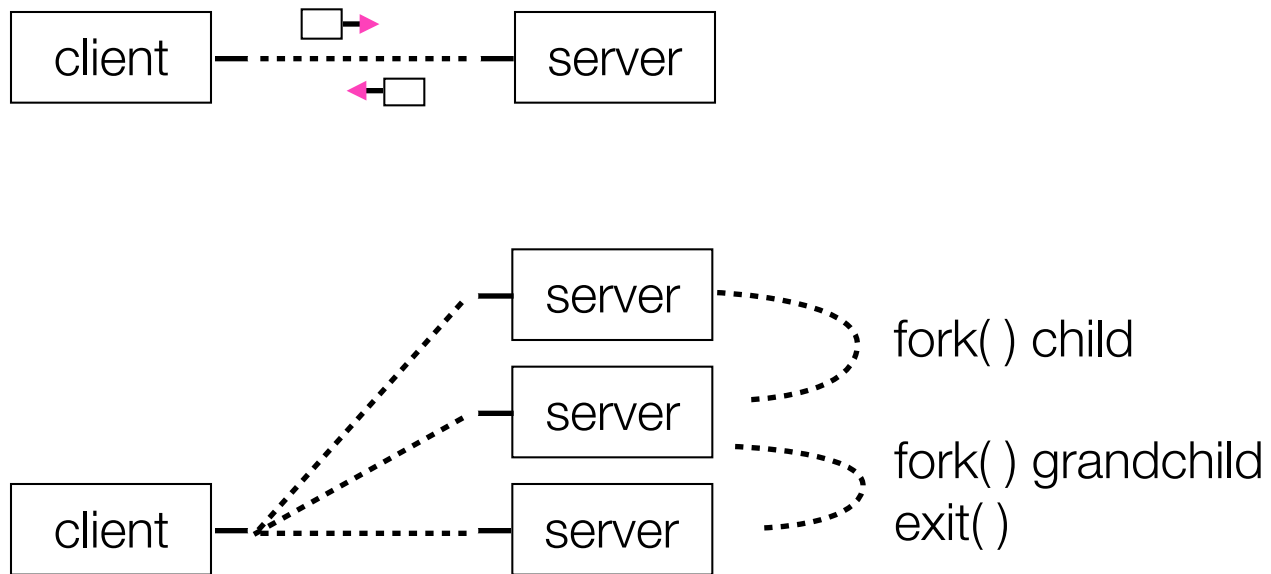

Graphically

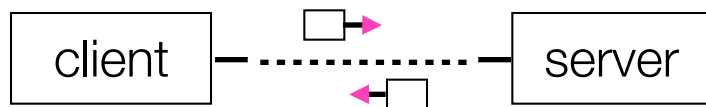
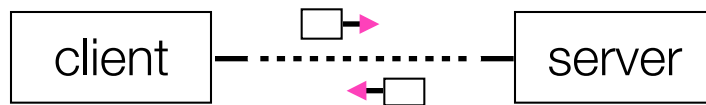

Graphically

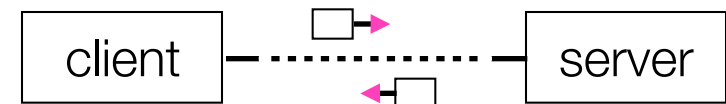
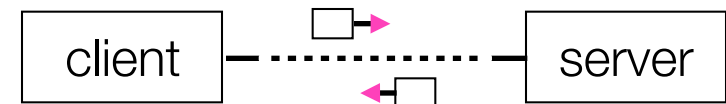
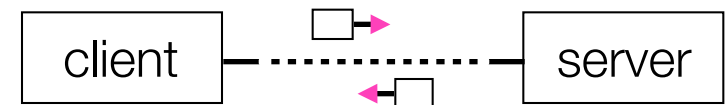
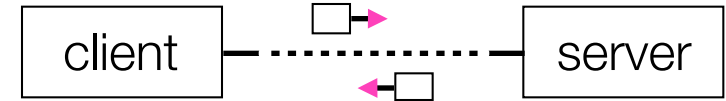
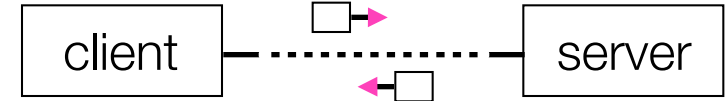
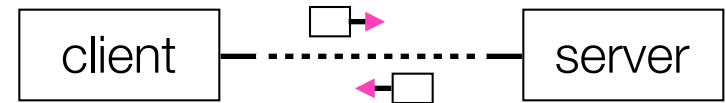
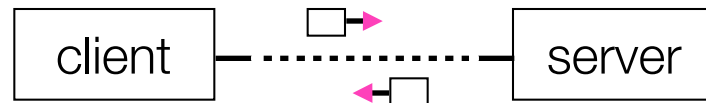
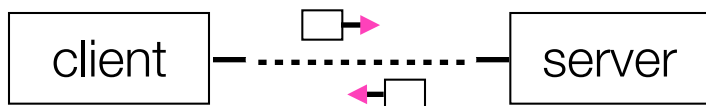
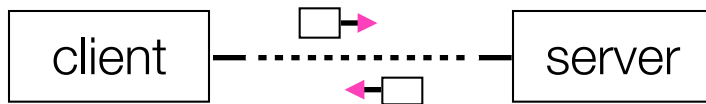

Concurrent with processes

*look at **searchserver_processes***

Whither concurrent processes?

Benefits

- almost as simple as sequential

 - in fact, most of the code is identical!

- parallel execution; good CPU, network utilization

Disadvantages

- processes are heavyweight

 - relatively slow to fork

 - context switching latency is high

- communication between processes is complicated

How slow is fork?

*run **forklatency.cc***

Implications?

0.25 ms per fork

maximum of $(1000 / 0.25) = 4,000$ connections per second per core

~0.5 billion connections per day per core

fine for most servers

too slow for a few super-high-traffic front-line web services

Facebook serves $O(750 \text{ billion})$ page views per day

would need 3,000 -- 6,000 cores just to handle `fork()`,
i.e., without doing any work for each connection!

threads

Threads are like lightweight processes

- like processes, they execute concurrently

 - multiple threads can run simultaneously on multiple cores/CPU's

- unlike processes, threads cohabit the same address space

 - the threads within a process see the same heap and globals

 - threads can communicate with each other through variables

 - but, threads can interfere with each other: need synchronization

 - each thread has its own stack

threads and the address space

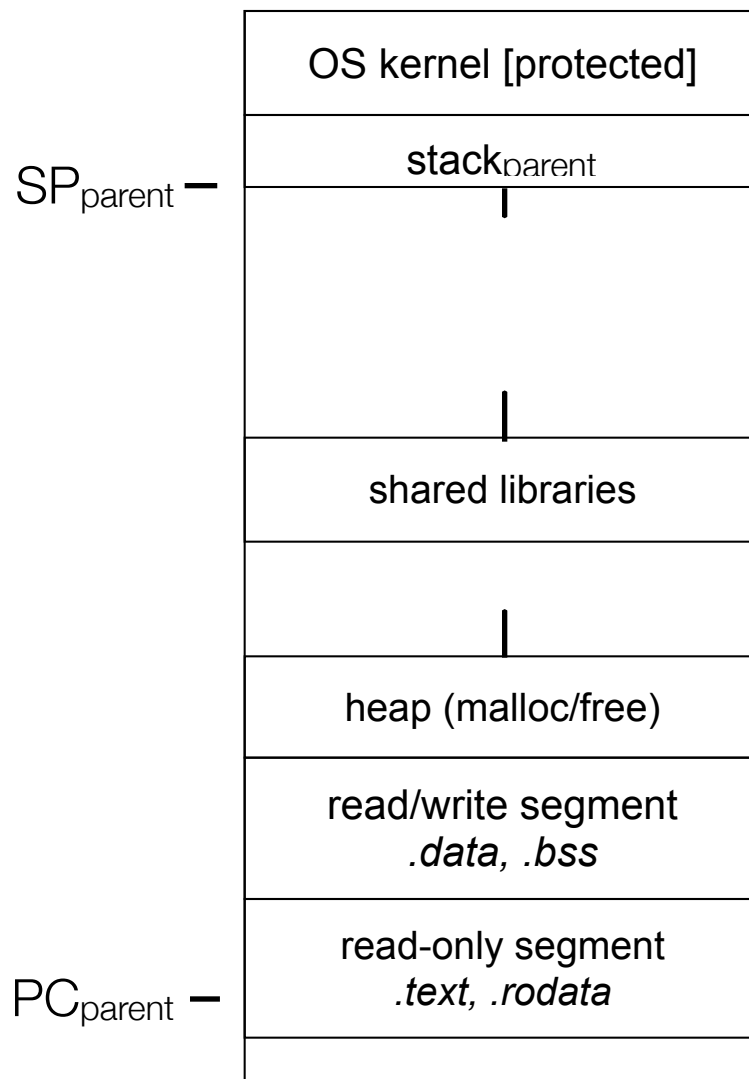

Pre- thread create

one thread of execution
running in the address space

the “main” thread

therefore, one stack, SP, PC

that main thread invokes a
function to create a new thread

typically “pthread_create()”

threads and the address space

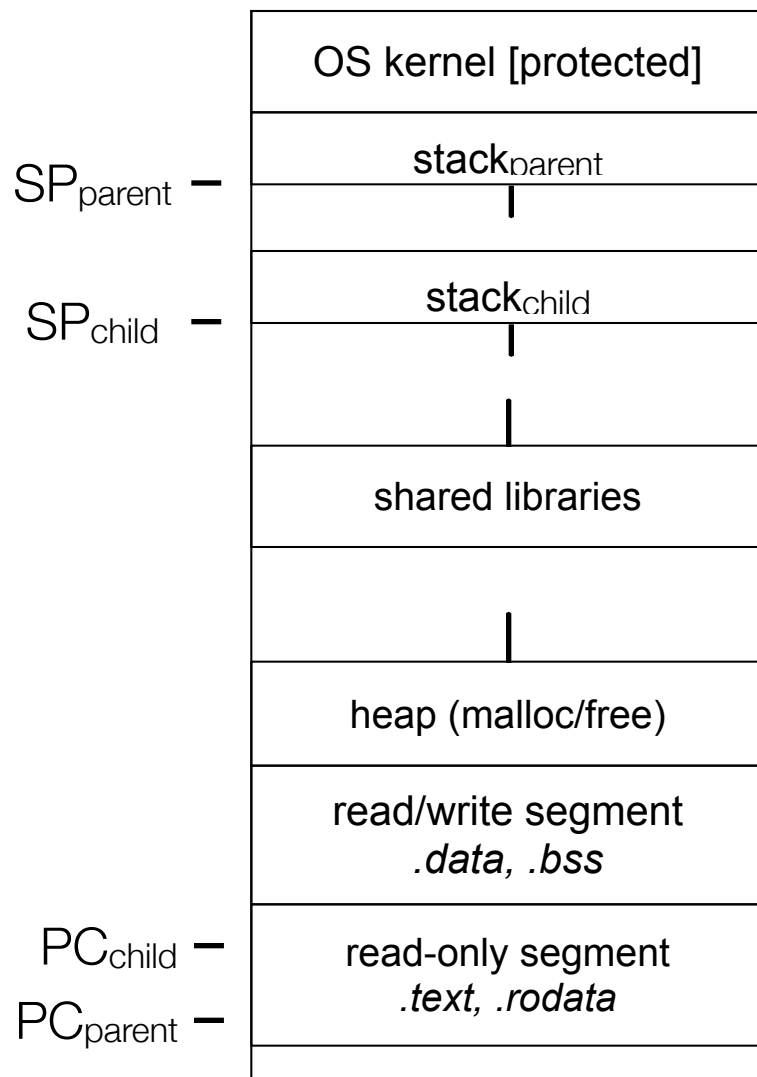

Post- thread create

two threads of execution
running in the address space

the “main” thread (parent)

the child thread

thus, two stacks, SPs, PCs

both threads share the heap
and text segment (globals)

they can cooperatively modify
shared data

threads

see `thread_example.cc`

Concurrent server with threads

A single **process** handles all of the connections

but, a parent **thread** forks (or dispatches) a new thread to handle each connection

the child thread:

- handles the new connection

- exits when the connection terminates

Graphically

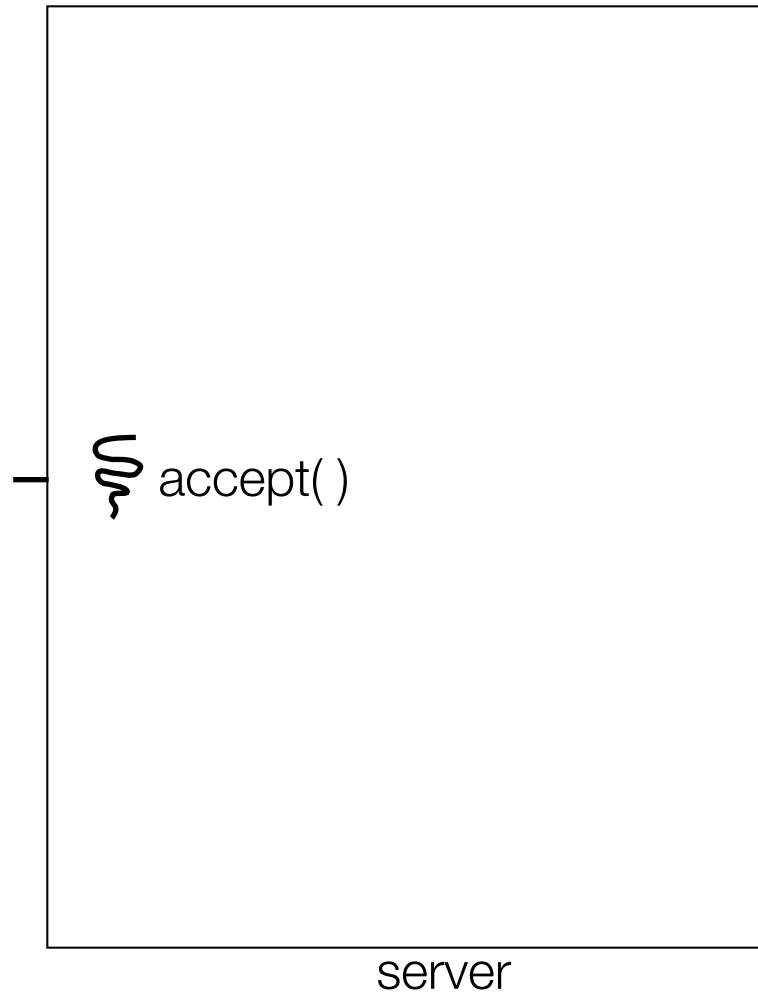

Graphically

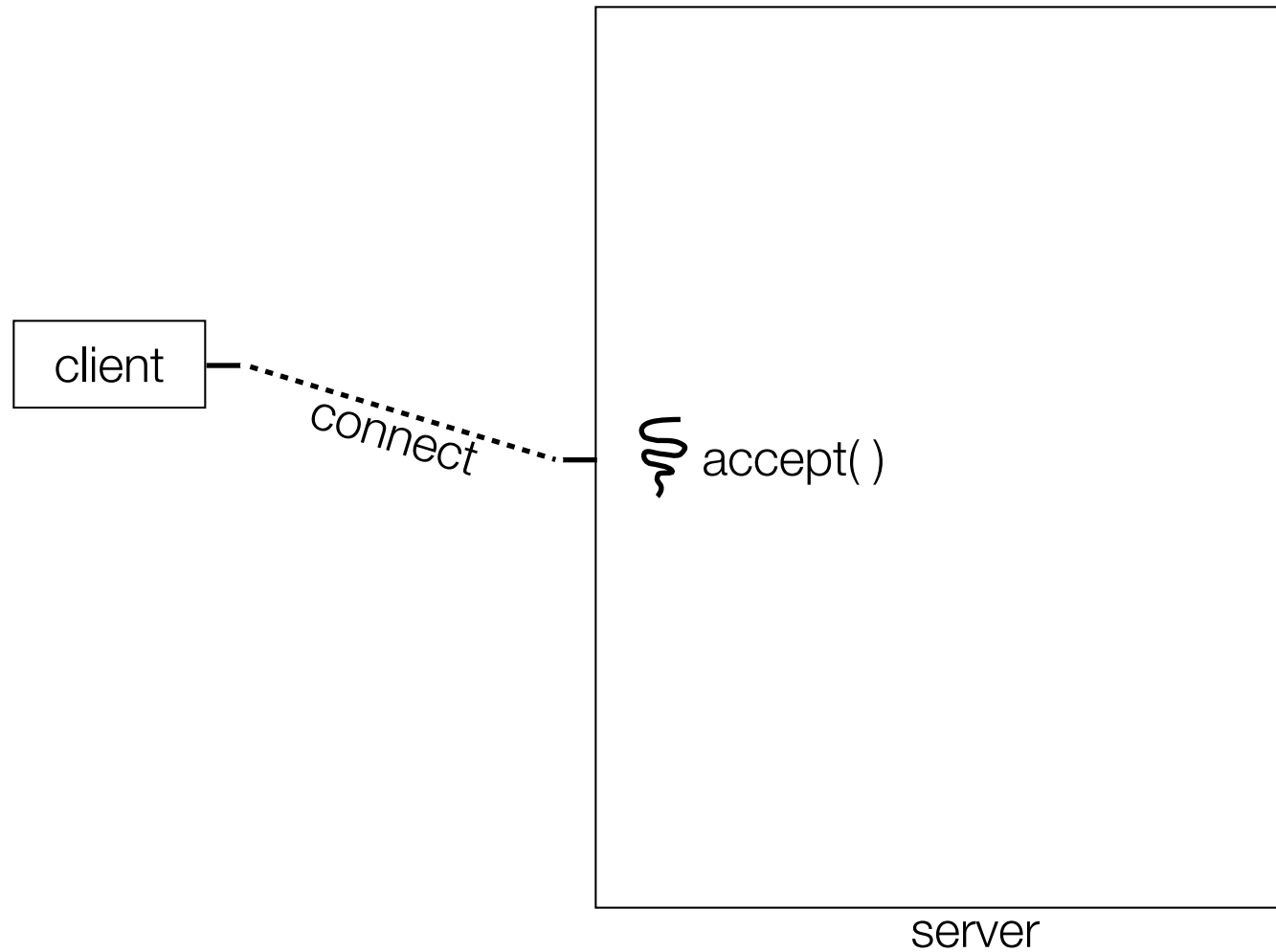

Graphically

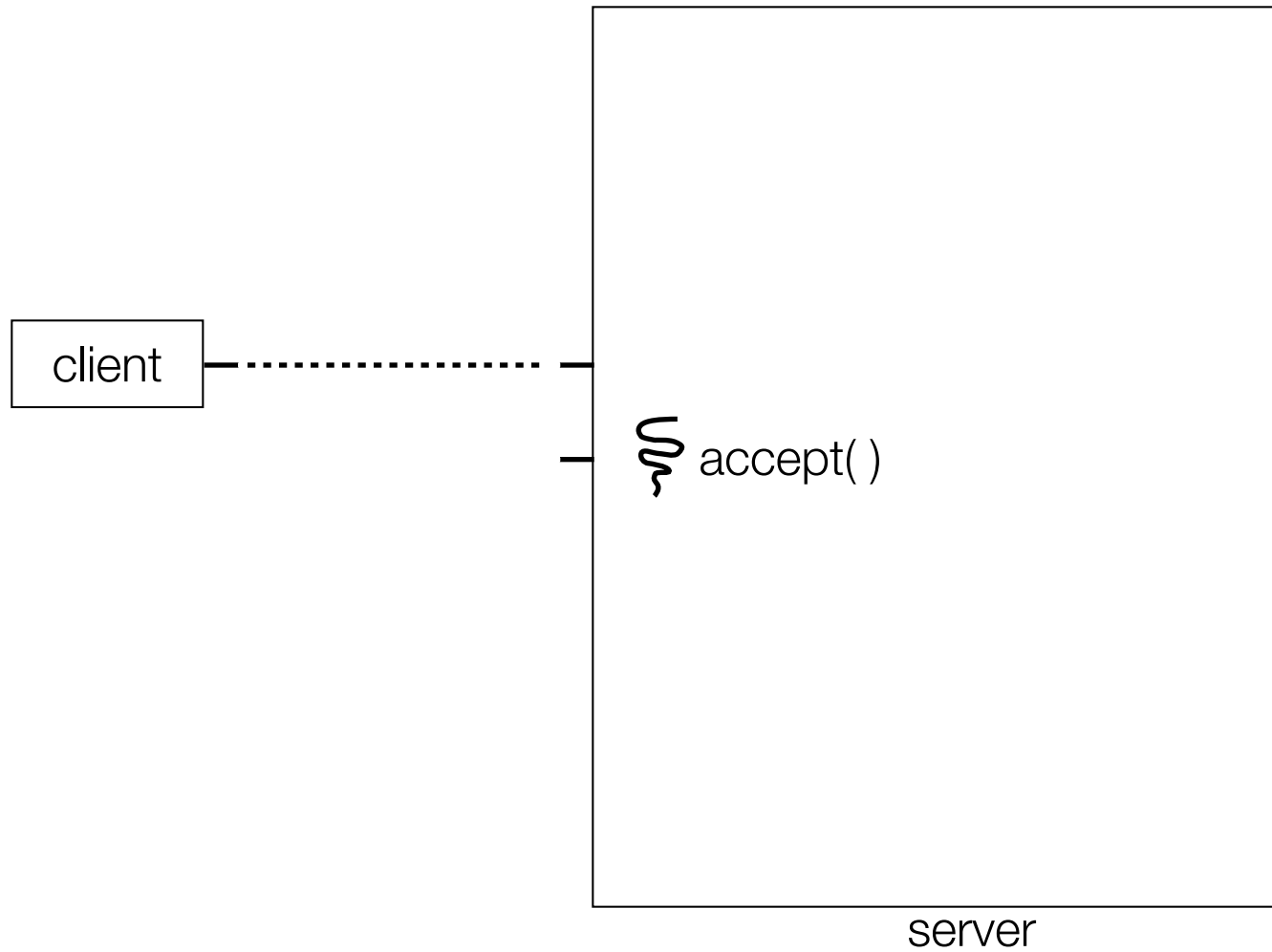

Graphically

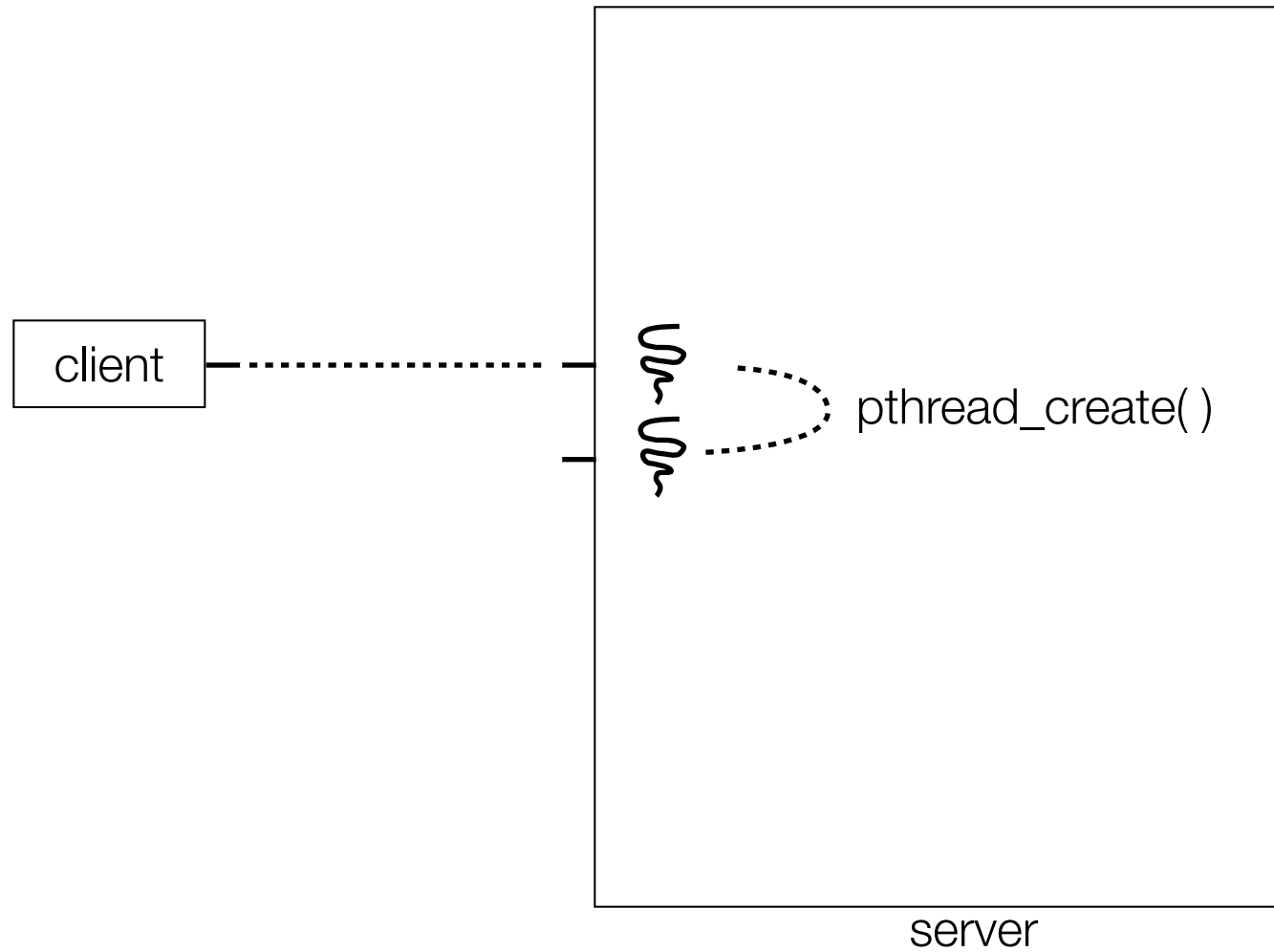

Graphically

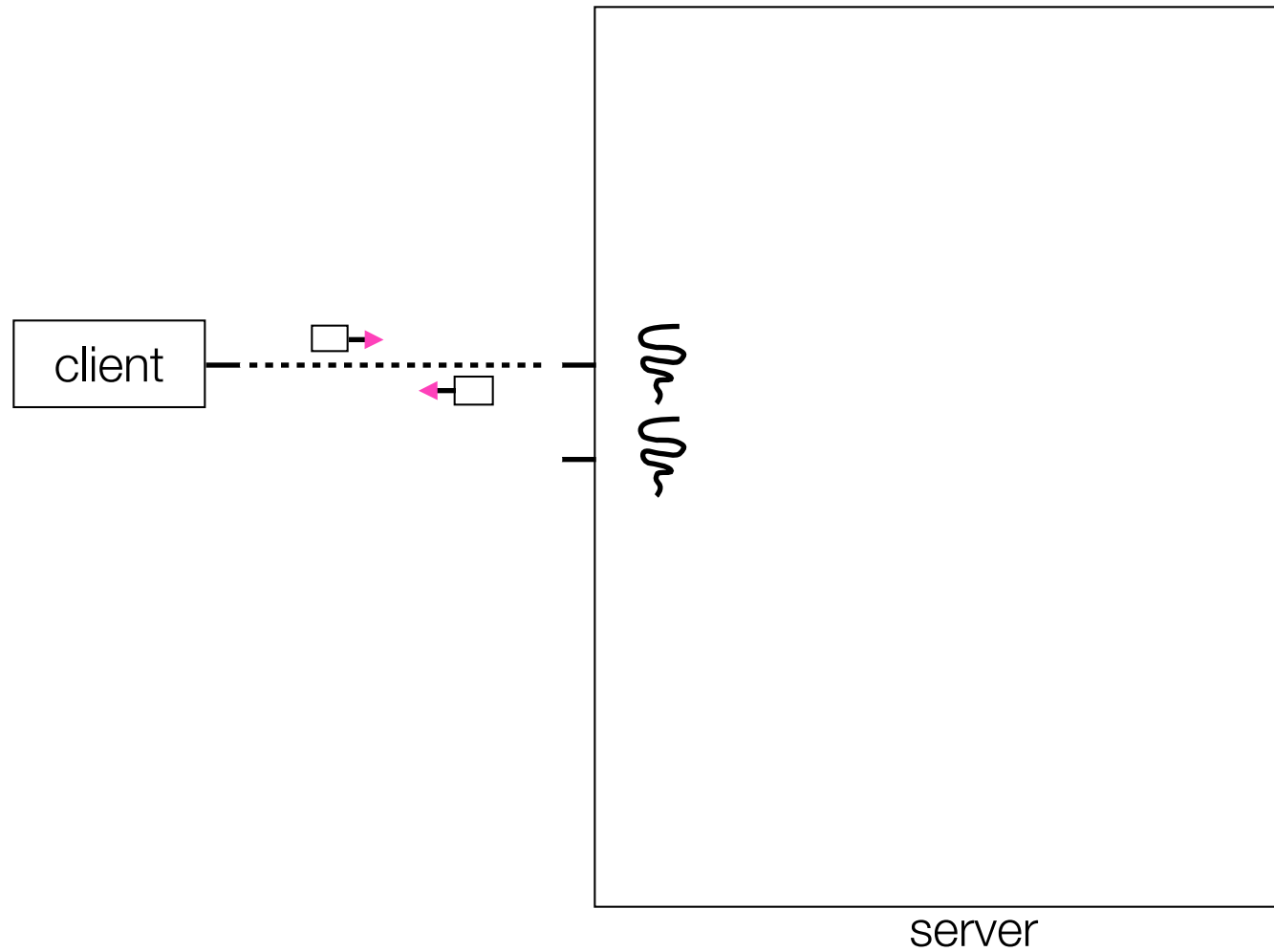

Graphically

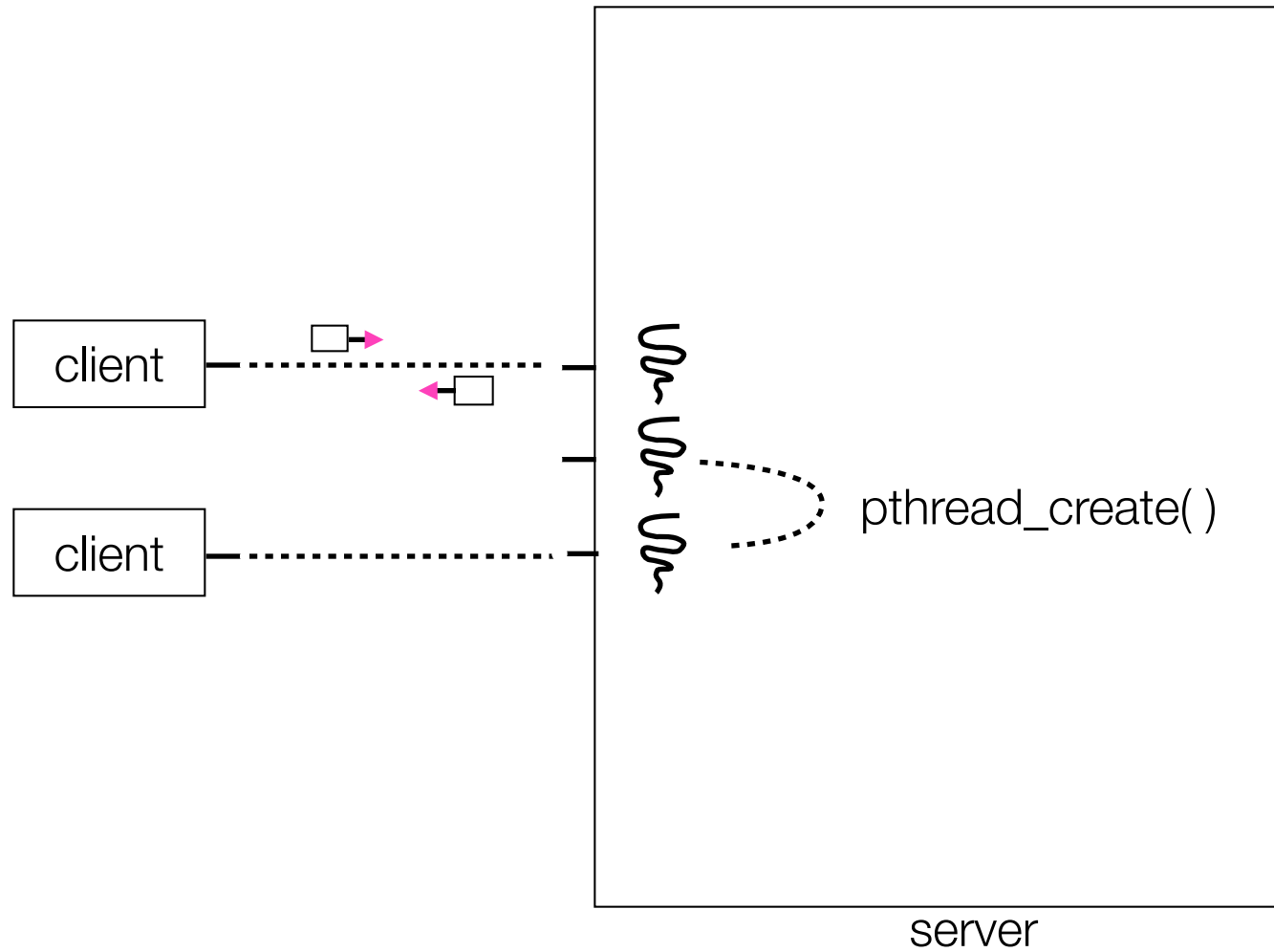

Graphically

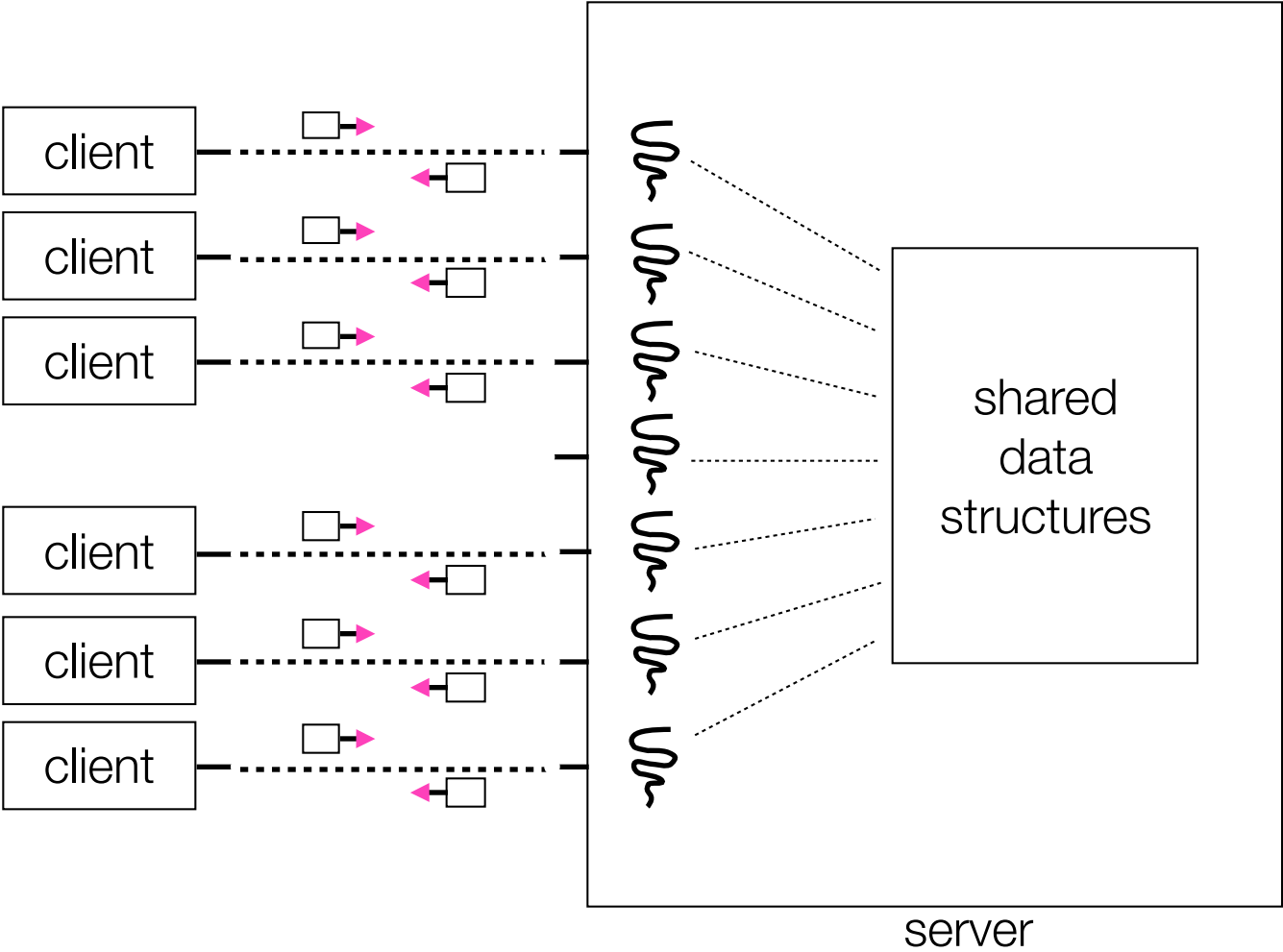

Concurrent with threads

*look at **searchserver_threads/***

Whither concurrent threads?

Benefits

straight-line code

still the case that much of the code is identical to sequential!

parallel execution; good CPU, network utilization

lower overhead than processes

shared-memory communication is possible

Disadvantages

synchronization is complicated

shared fate within a process; one rogue thread can hurt you badly

How fast is pthread_create?

*run **threadlatency.cc***

Implications?

0.036 ms per thread create; ~10x faster than process forking

maximum of $(1000 / 0.018) = \sim 60,000$ connections per second

~10 billion connections per day per core

much better

But, writing safe multithreaded code can be serious voodoo

Thread Pools

In real servers we'd like to avoid overhead needed to create a new thread or process for every request

Idea: thread pools

Create a set of worker threads or processes on server startup, put them in a queue

When a request arrives, remove the first worker thread from the queue and assign it to handle the request

When a worker is done it places itself back on the queue and then sleeps until dequeued and handed a new request

Threads and races

What happens if two threads try to mutate the same data structure?

they might interfere in painful, non-obvious ways, depending on the specifics of the data structure

imagine if two threads try to push an item onto the head of the linked list at the same time

depending on how the threads interleave, you might end up with a correct answer, or you might break the data structure altogether

Simple “race” example

If no milk, buy some more

liveness: if out, somebody buys

safety: at most one person buys

What happens with multiple threads?

```
if (!milk) {  
    buy milk  
}
```

Simple “race” example

Does this fix the problem?

```
if (!note) {  
    if (!milk) {  
        leave note  
        buy milk  
        remove note  
    }  
}
```

Synchronization

Synchronization is the act of preventing two (or more) concurrently running threads from interfering with each other when operating on shared data

need some mechanism to coordinate the threads

“let me go first, then you go”

many different coordination mechanisms have been invented

take cse451 for details

Locks

lock acquire

wait until the lock is free, then take it

lock release

release the lock

if other threads are waiting for it

wake up exactly one of them

give it the lock

simplifies concurrent code

prevents more than one thread from entering a *critical section*

```
... non-critical code ...
```

```
lock.acquire();
```

```
    critical section
```

```
lock.release();
```

```
... non-critical code ...
```

Simple “race” solution

What is the critical section?

checking for milk

buying more milk if out

These two steps must be uninterrupted, i.e., **atomic**

solution: protect the critical section with a lock

```
milk_lock.lock()

if (!milk) {
    buy milk
}

milk_lock.unlock()
```

threads and locks

`pthread_mutex_init()`

creates a mutex (a.k.a. a lock)

`pthread_mutex_lock()`

grabs the lock

`pthread_mutex_unlock()`

releases the lock

see ***lock_example.cc***

C++ 11 Threads

C++ 11 added threads and concurrency to the libraries

`<thread>` - thread objects

`<mutex>` - locks to handle critical sections

`<condition_variable>` - used to block objects until notified to resume

`<atomic>` - indivisible, atomic operations

`<future>` - asynchronous access to data

Might be built on top of `<pthread.h>`, maybe not

Definitely use in C++ 11 code, but `pthread` will still be around for a long, long time

Exercise 1

Write a simple “proxy” server

- forks a process for each connection

- reads an HTTP request from the client

 - relays that request to `www.cs.washington.edu`

- reads the response from `www.cs.washington.edu`

 - relays the response to the client, closes the connection

Try visiting your proxy using a web browser :)

Exercise 2

Write a client program that:

loops, doing “requests” in a loop. Each request must:

- connect to one of the echo servers from the lecture

- do a network exchange with the server

- close the connection

keeps track of the latency (time to do a request) distribution

keeps track of the throughput (requests / s)

prints these out

See you on Wednesday !