

CSE 333

Lecture 16 -- networks

Hal Perkins

Department of Computer Science & Engineering

University of Washington



Administrivia

HW3 due Thursday night

Today - overview of networking

Then - client-side and server-side TCP sockets

Rest of the quarter

HW4 out Friday; due last Wednesday of the quarter (plus late days if you have/need them)

A few more exercises, but nothing more due this week

Second exam in class last day of the quarter, Fri. 8/19

Review in section the previous day

Networks from 10,000ft

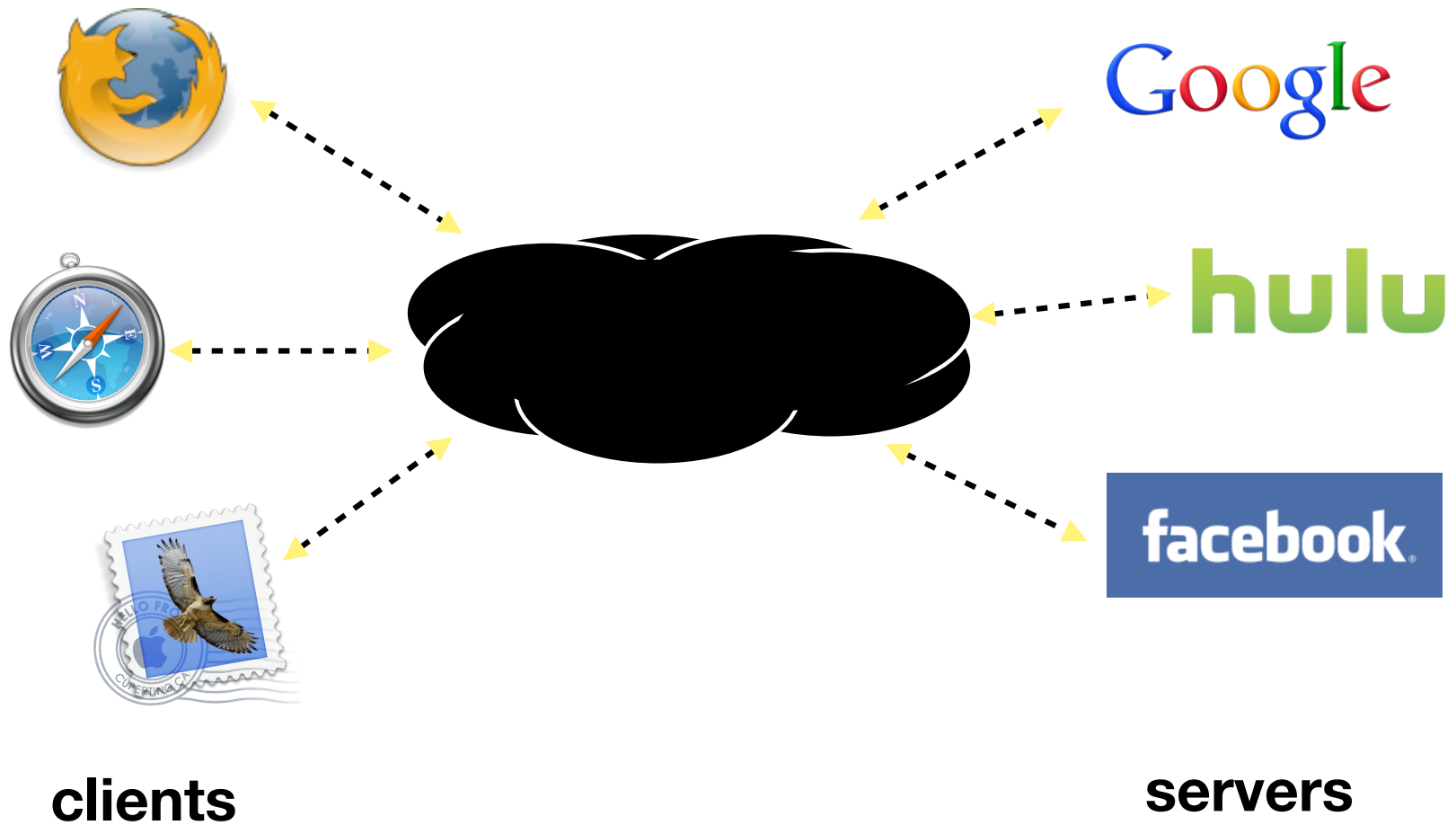

The “physical” layer

Individual bits are modulated onto a wire or transmitted over radio
physical layer specifies how bits are encoded at a signal level
e.g., a simple spec would encode “1” as +1V, “0” as -1V

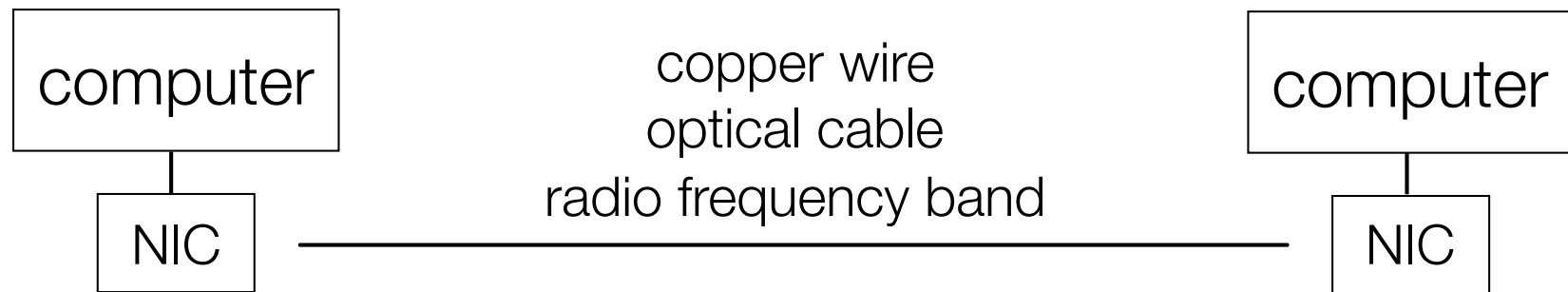
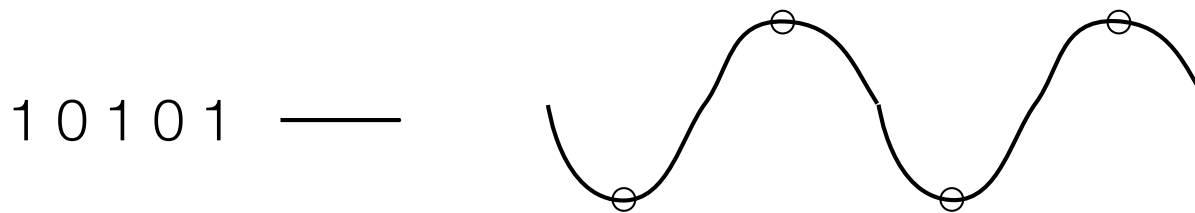

The “data link” layer

Multiple computers on a LAN contend for the network medium

media access control (MAC) specifies how computers cooperate

link layer also specifies how bits are packetized and NICs are addressed

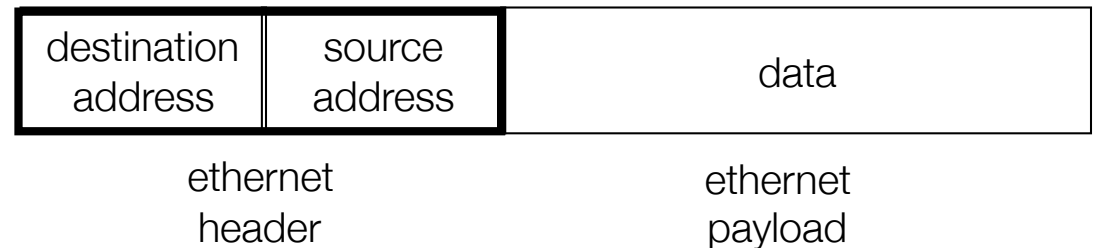
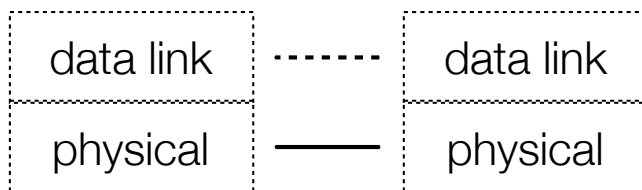
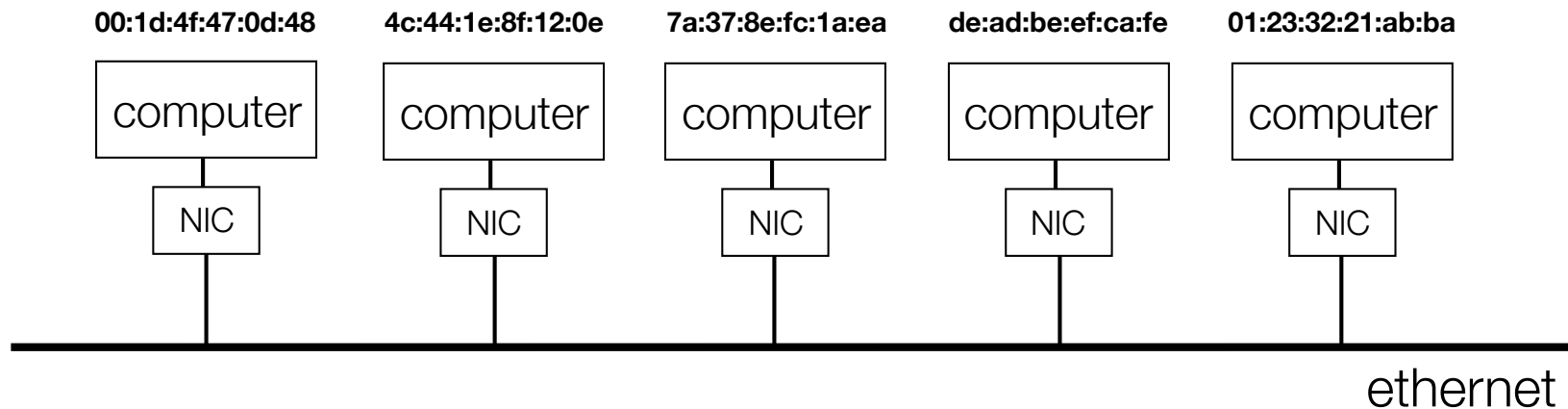

The “network” layer (IP)

The Internet Protocol (IP) routes packets across multiple networks

every computer has a unique Internet address (IP address)

individual networks are connected by routers that span networks

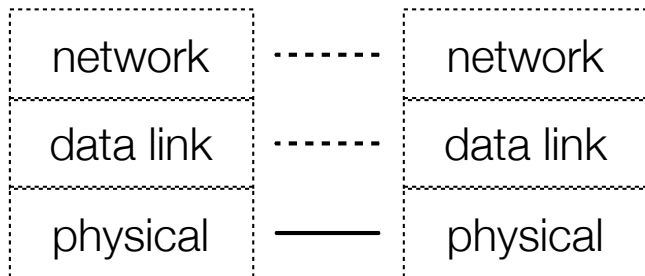
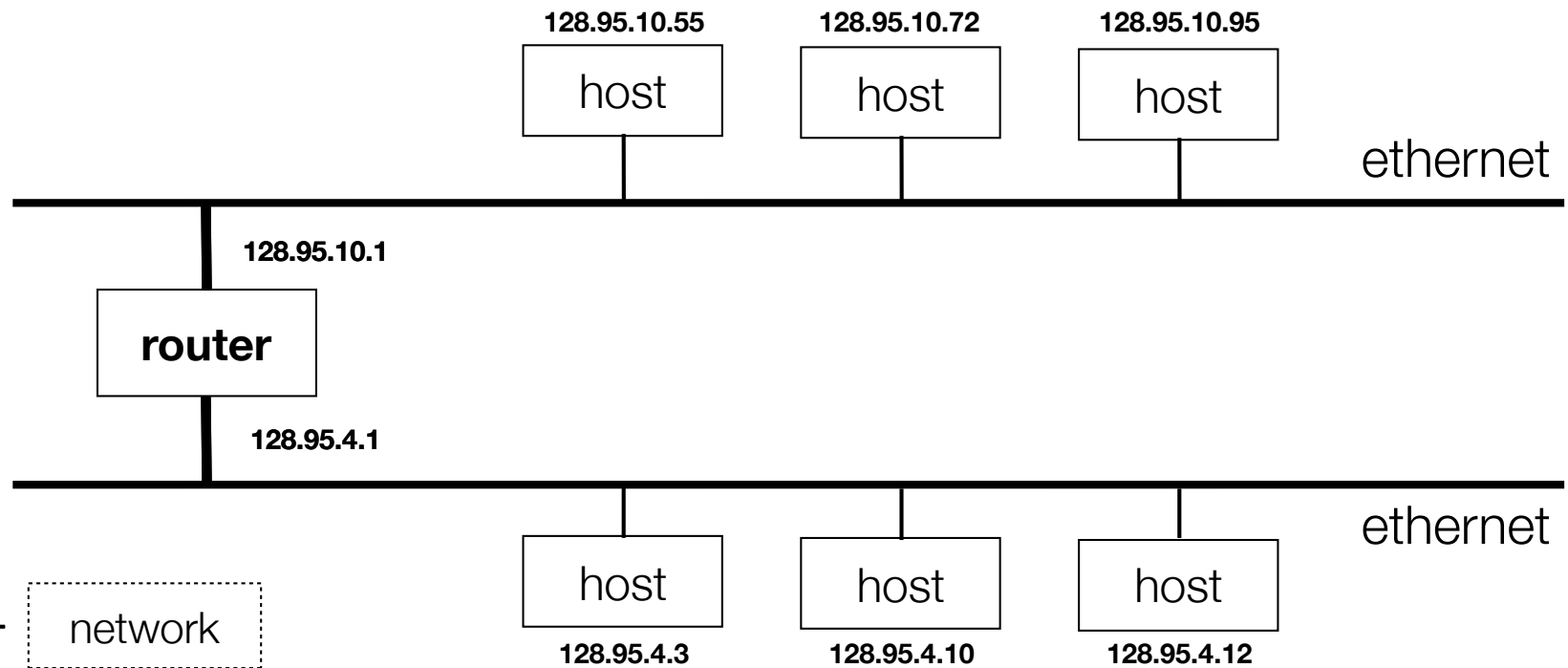

The “network” layer (IP)

Protocols to:

let a host find the MAC address of an IP address on the same network

let a router learn about other routers and figure out how to get IP packets one step closer to their destination

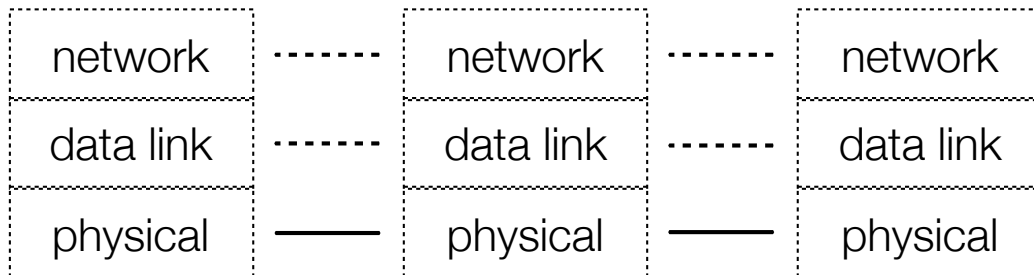
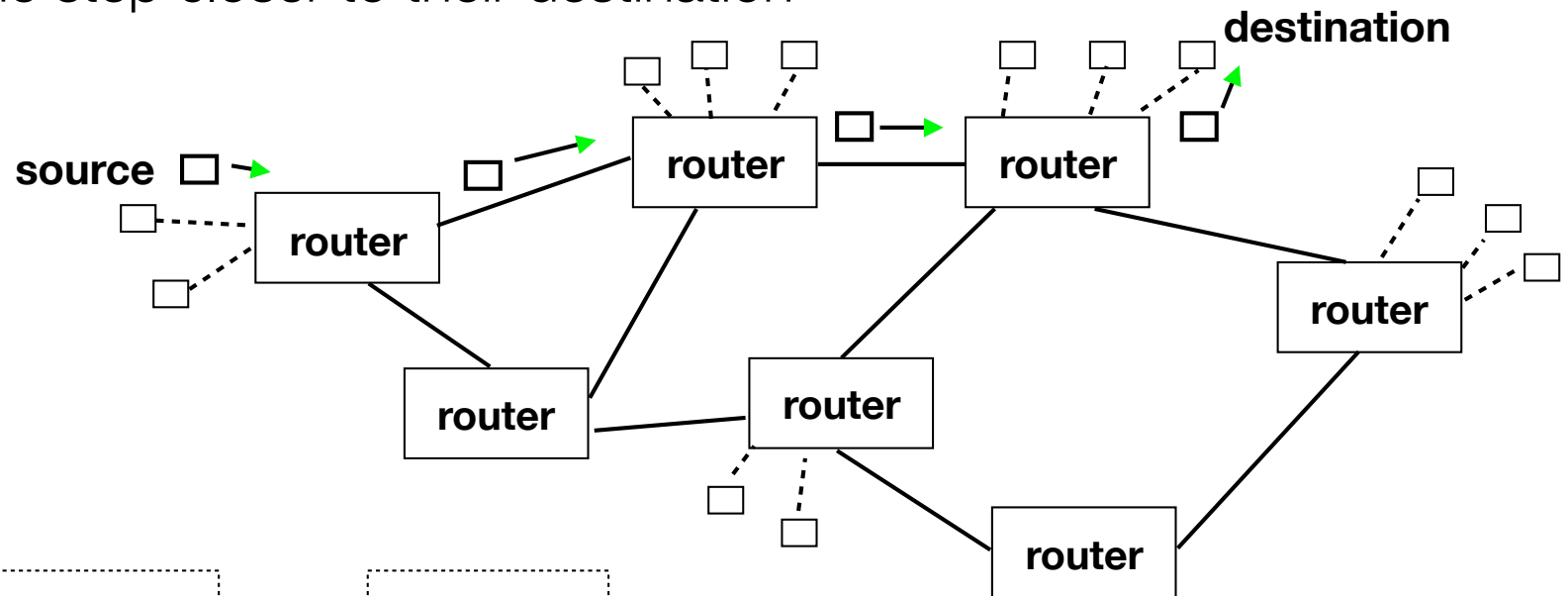

The “network” layer (IP)

Packet encapsulation

an IP packet is encapsulated as the payload of an Ethernet frame

as IP packets traverse networks, routers pull out the IP packet from an ethernet frame and plunk it into a new one on the next network

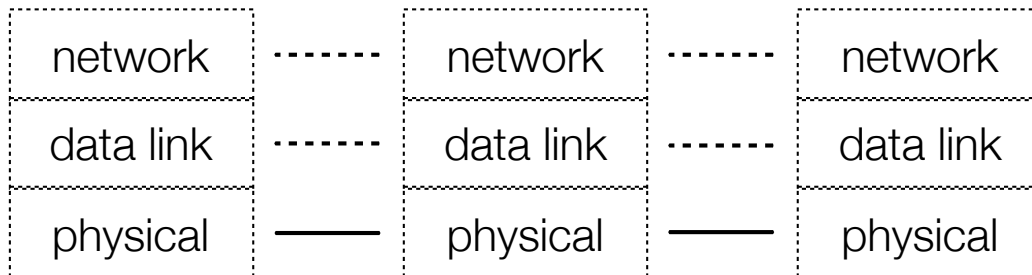
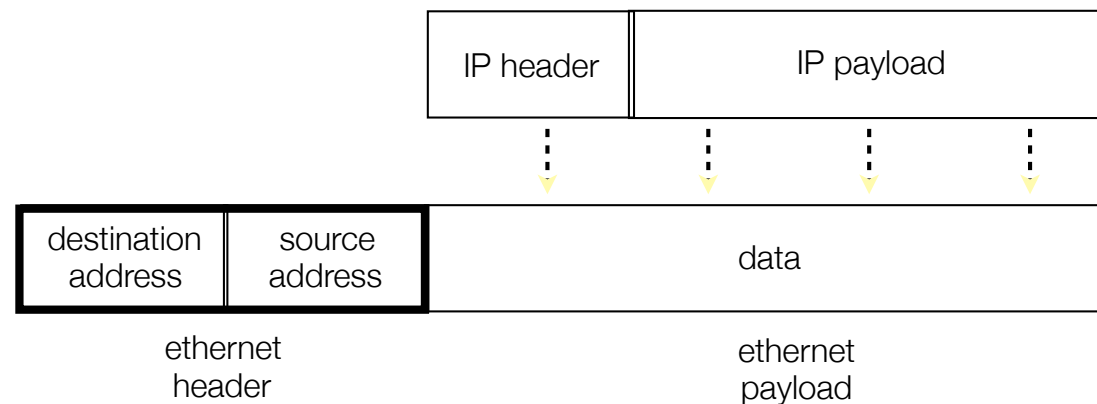

The “transport” layer (TCP, UDP)

TCP

the “transmission control protocol”

provides apps with reliable, ordered, congestion-controlled byte streams

fabricates them by sending multiple IP packets, using sequence numbers to detect missing packets, and retransmitting them

a single host (IP address) can have up to 65,535 “ports”

kind of like an apartment number at a postal address

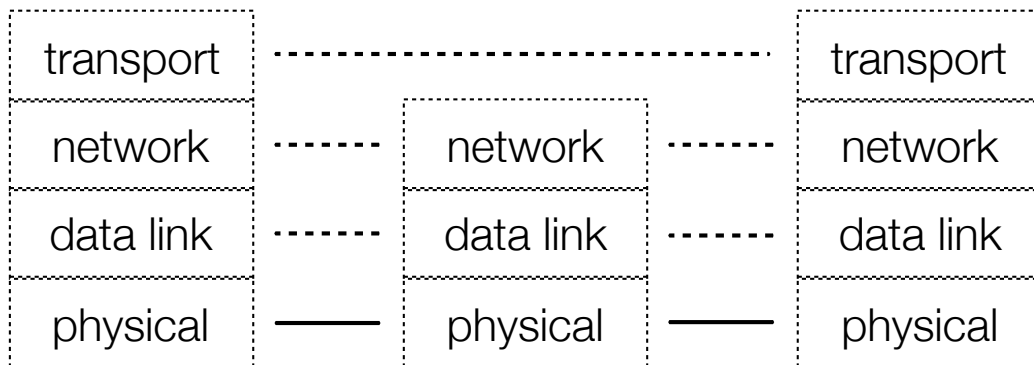

The “transport” layer (TCP, UDP)

TCP

useful analogy: how would you send a book by mail via postcards?

split the book into multiple postcards, send each one by one, including sequence numbers that indicate the assembly order

receiver sends back postcards to acknowledge receipt and indicate which got lost in the mail

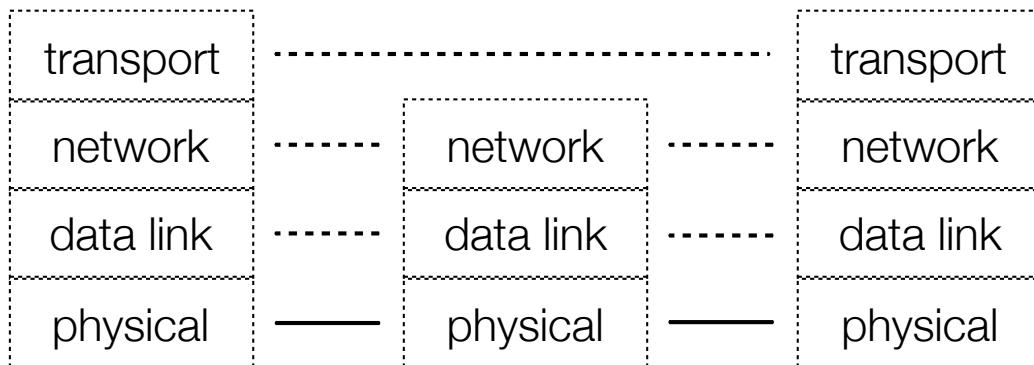

The “transport” layer (TCP)

Packet encapsulation -- same as before!

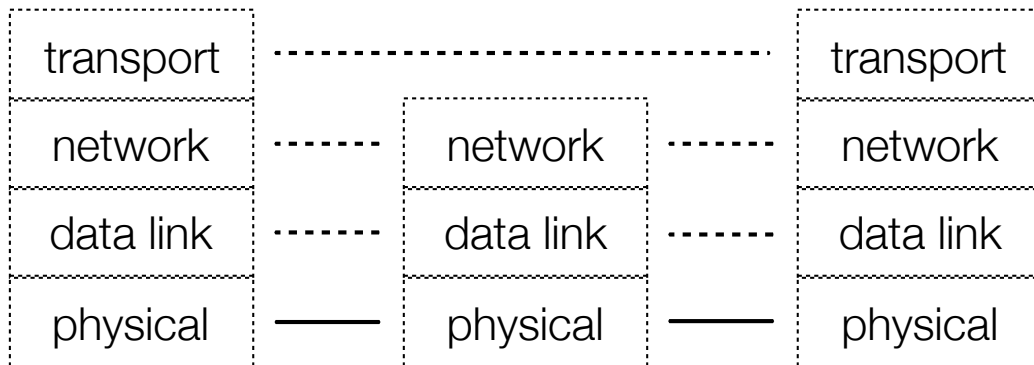
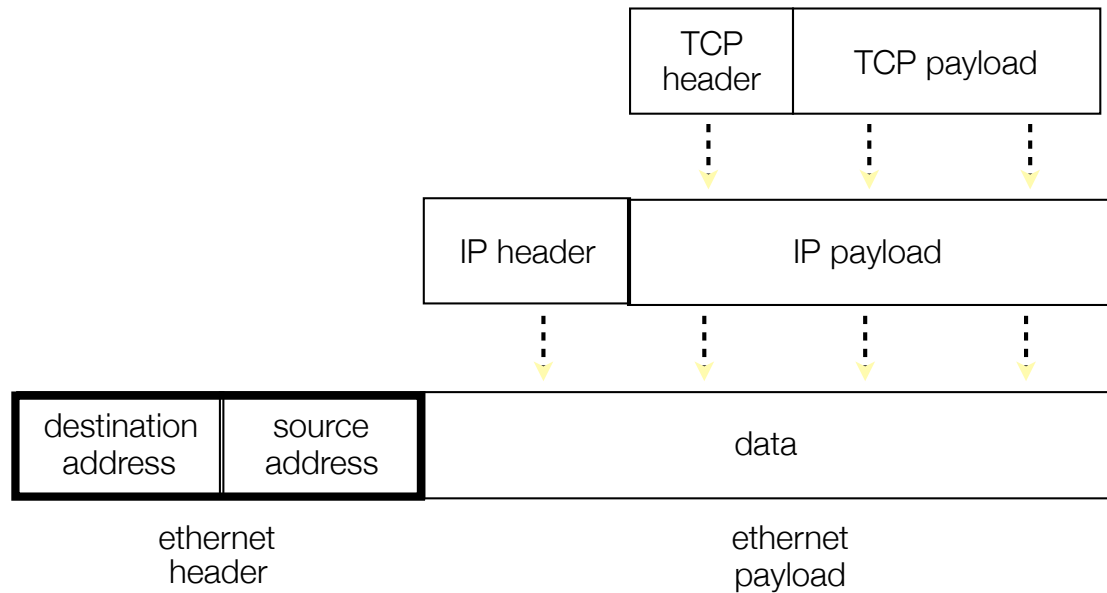

The “transport” layer (TCP)

Applications use OS services to establish TCP streams

the “Berkeley sockets” API -- a set of OS system calls

clients **connect()** to a server IP address + application port number

servers **listen()** for and **accept()** client connections

clients, servers **read()** and **write()** data to each other

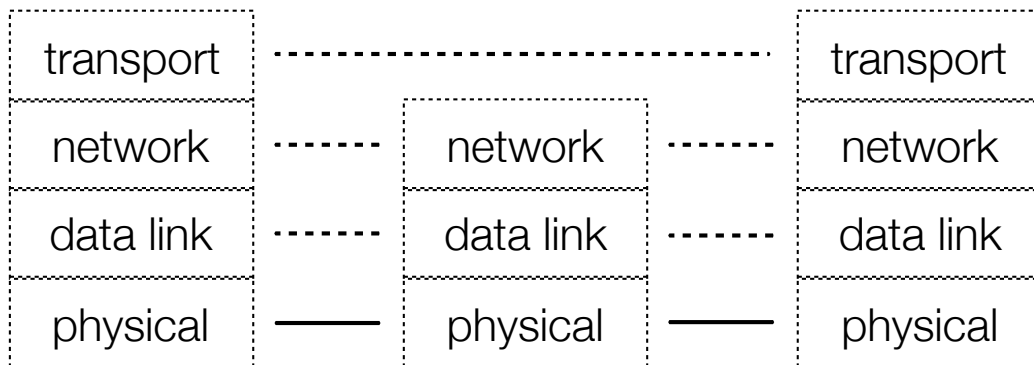

The “transport” layer (UDP)

UDP

the “user datagram protocol”

provides apps with unreliable packet delivery

UDP datagrams are fragmented into multiple IP packets

UDP is a really thin, simple layer on top of IP

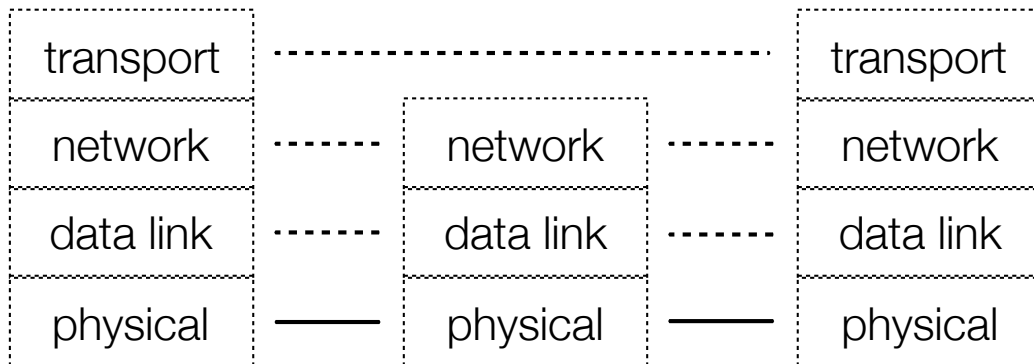

The (mostly missing) layers 5,6

Layer 5: session layer

supposedly handles establishing, terminating application sessions

RPC kind of fits in here

Layer 6: presentation layer

supposedly maps application-specific data units into a more network-neutral representation

encryption (SSL) kind of fits in here

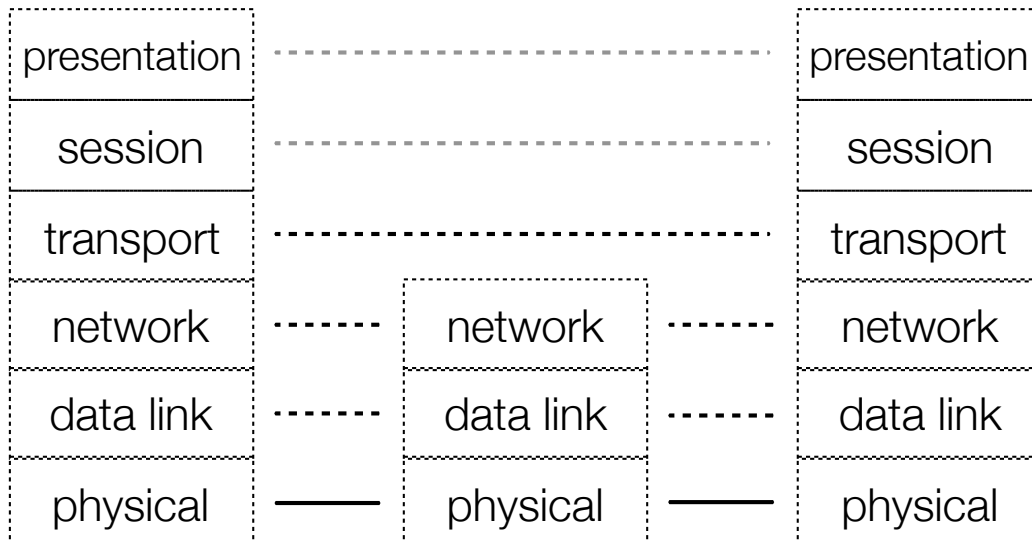

The “application” layer

Application protocols

the format and meaning of messages between application entities

e.g., HTTP is an application level protocol that dictates how web browsers and web servers communicate

HTTP is implemented on top of TCP streams

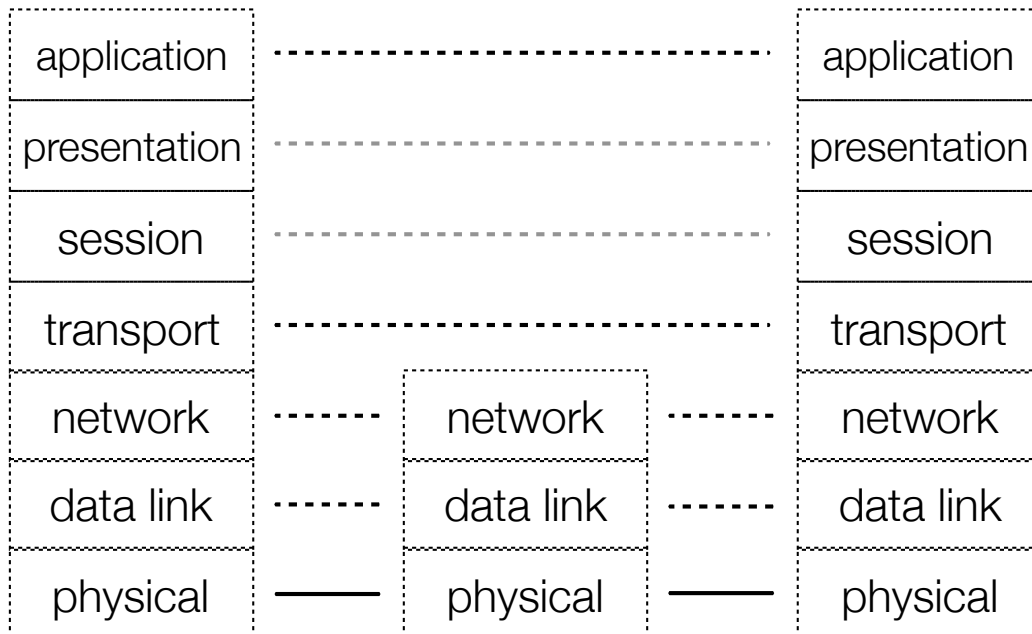

The “application” layer

Packet encapsulation -- same as before!

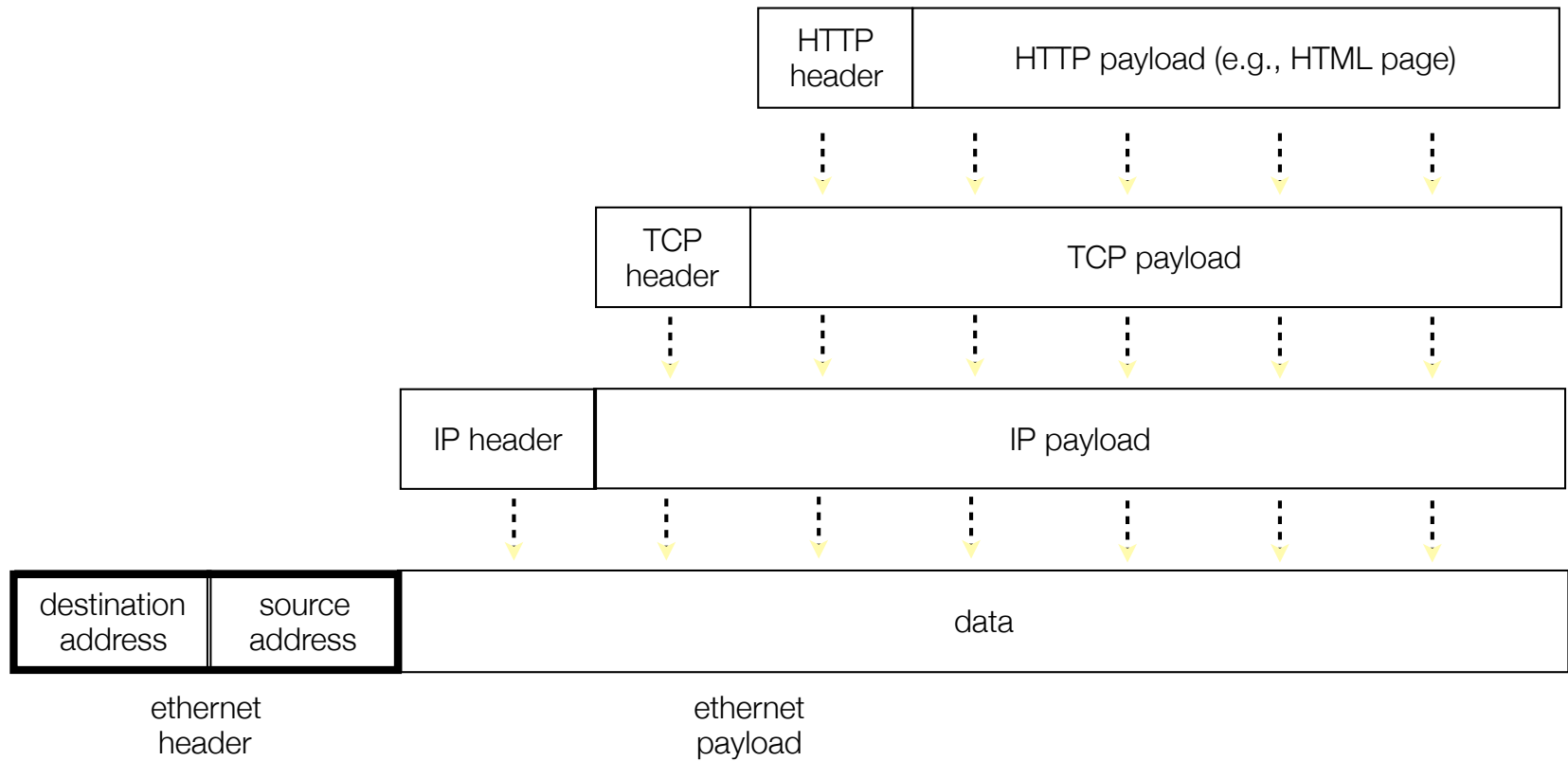

The “application” layer

Packet encapsulation -- same as before!

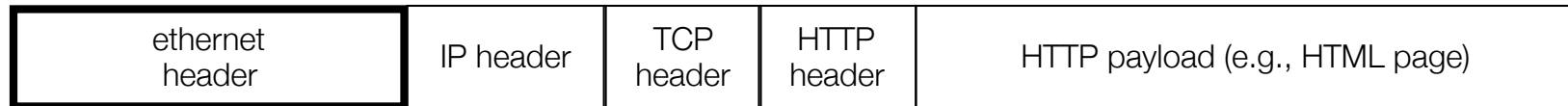

The “application” layer

Popular application-level protocols:

DNS: translates a DNS name (**www.google.com**) into one or more IP addresses (74.125.155.105, 74.125.155.106, ...)

a hierarchy of DNS servers cooperate to do this

HTTP: web protocols

SMTP, IMAP, POP: mail delivery and access protocols

ssh: remote login protocol

bittorrent: peer-to-peer, swarming file sharing protocol

See you on Friday!
(But wait! There's More...)