

CSE 333

Lecture 21 -- fork, pthread_create

Hal Perkins

Department of Computer Science & Engineering

University of Washington



Administrivia

HW4 is due Wednesday night

- **<panic>** if you haven't started yet **</panic>**
- Usual late days apply *if* you have any left

pthreads exercise due Monday before class

Please fill out course evals when they're available

Final exam next Friday in class

- Review in section next week
- Topic list and old exams on web now

Some common HW4 bugs

Your server works, but is really really slow

- check the 2nd argument to the QueryProcessor constructor

Funny things happen after the first request

- make sure you're not destroying the HTTPConnection object too early (e.g., falling out of scope in a while loop)

Server crashes on blank request

- make sure you handle the case that read() [or WrappedRead] returns 0

Previously

We implemented a searchserver, but it was sequential

- it processed requests one at a time, in spite of client interactions blocking for arbitrarily long periods of time
 - ▶ this led to terrible performance

Servers should be concurrent

- process multiple requests simultaneously
 - ▶ issue multiple I/O requests simultaneously
 - ▶ overlap the I/O of one request with computation of another
 - ▶ utilize multiple CPUs / cores

Today

We'll go over three versions of searchserver

- sequential
- concurrent
 - ▶ processes [**fork()**]
 - ▶ threads [**pthread_create()**]

Alternative (which we won't get to): non-blocking, event driven version

- ▶ non-blocking I/O [**select()**]

Reference: *Computer Systems: A Programmer's Perspective*

- 351 textbook: good source for process/thread/OS concepts

Sequential

pseudocode:

```
listen_fd = Listen(port);  
  
while(1) {  
    client_fd = accept(listen_fd);  
    buf = read(client_fd);  
    resp = ProcessQuery(buf);  
    write(client_fd, resp);  
    close(client_fd);  
}
```

*look at **searchserver_sequential/***

Whither sequential?

Benefits

- super simple to build

Disadvantages

- incredibly poorly performing
 - ▶ one slow client causes **all** others to block
 - ▶ poor utilization of network, CPU

fork()

```
pid_t fork(void);
```

Fork is used to create a new process (the “child”) that is an exact clone of the current process (the “parent”)

- everything is cloned (except threads)
 - ▶ all variables, file descriptors, open sockets, etc.
 - ▶ the heap, the stack, etc.
- primarily used in two patterns
 - ▶ servers: fork a child to handle a connection
 - ▶ shells: fork a child, which then exec’s a new program

fork() and address spaces

Remember this picture...?

- a process executes within an **address space**
- the address space includes:
 - ▶ a stack (for stack frames)
 - ▶ heap (for dynamically allocated data)
 - ▶ text segment (containing code)
 - ▶ etc.

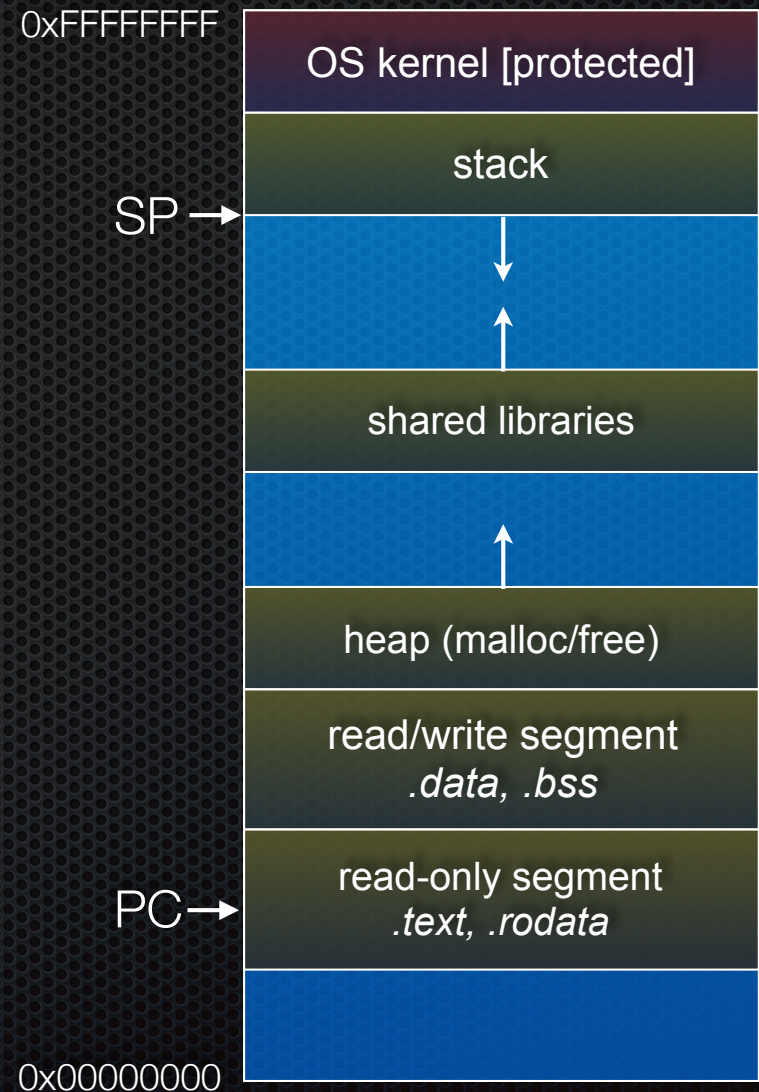

fork() and address spaces

Fork causes the OS to clone the address space, creating a brand new process

- the new process starts life as a **copy** the old process in (nearly) every way
- the **copies** of the heap, stack, text segment, etc. are (nearly) identical
- the new process has **copies** of the parent's data structures, stack-allocated variables, open file descriptors, and so on

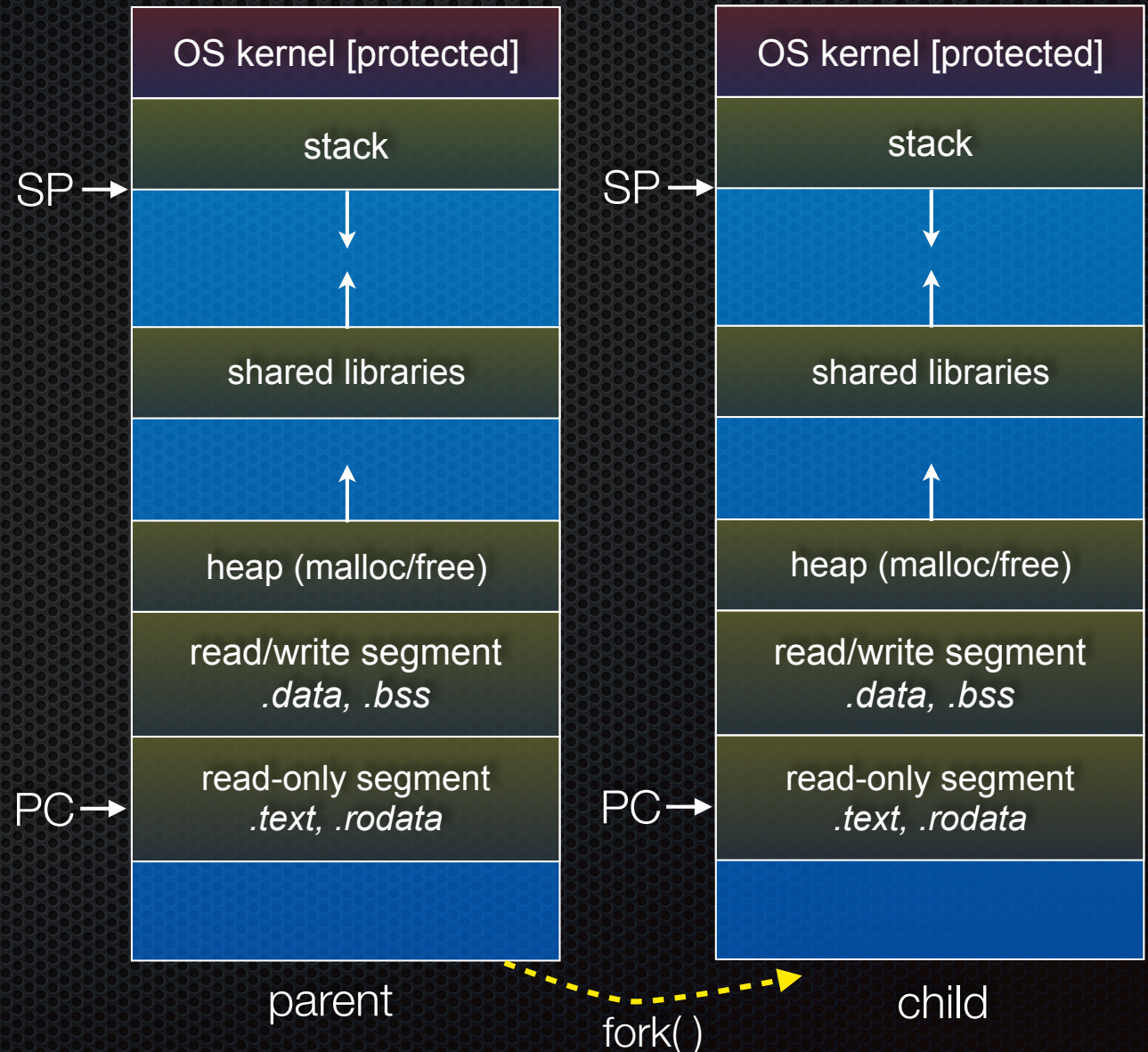

fork()

fork() has peculiar semantics

- the parent invokes fork()
- the operating system clones the parent
- **both** the parent and the child return from fork
 - ▶ parent receives child's pid
 - ▶ child receives a "0" as pid

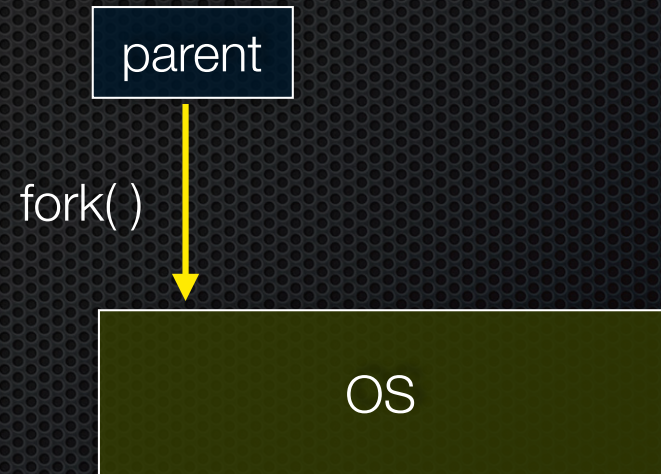

fork()

fork() has peculiar semantics

- the parent invokes fork()
- the operating system clones the parent
- **both** the parent and the child return from fork
 - ▶ parent receives child's pid
 - ▶ child receives a "0" as pid

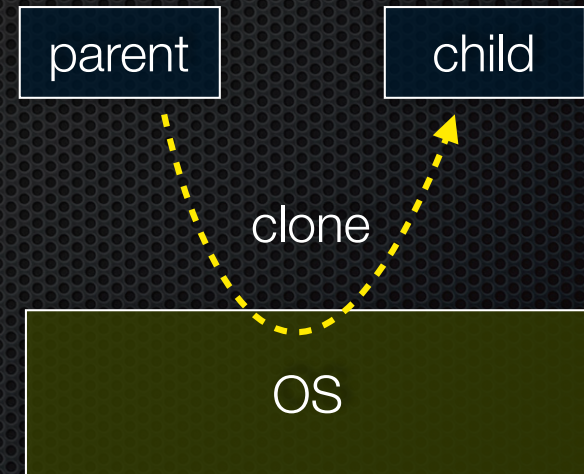

fork()

fork() has peculiar semantics

- the parent invokes fork()
- the operating system clones the parent
- **both** the parent and the child return from fork
 - ▶ parent receives child's pid
 - ▶ child receives a "0" as pid

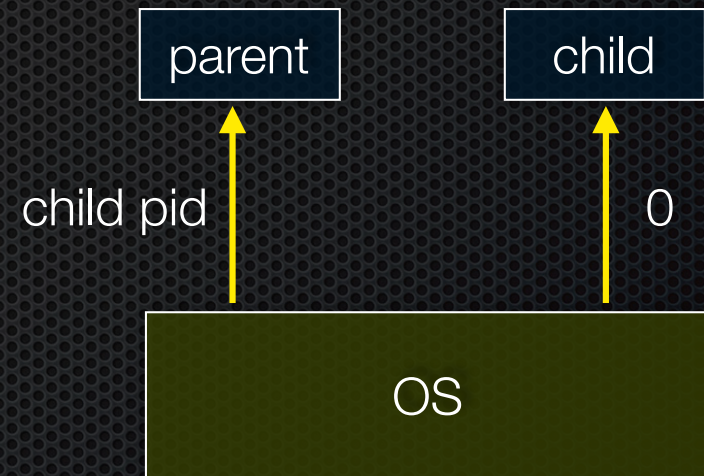

fork()

fork_example.cc

Concurrency with processes

The **parent** process blocks on **accept()**, waiting for a new client to connect

- when a new connection arrives, the parent calls **fork()** to create a **child** process
- the child process handles that new connection, and **exit()**'s when the connection terminates

Remember that children become “zombies” after death

- option a) parent calls **wait()** to “reap” children
- option b) use the double-fork trick

Graphically

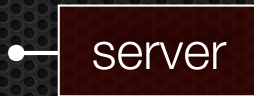

Graphically



Graphically

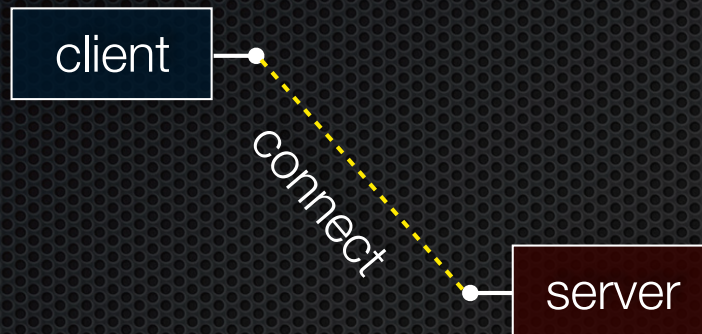

Graphically

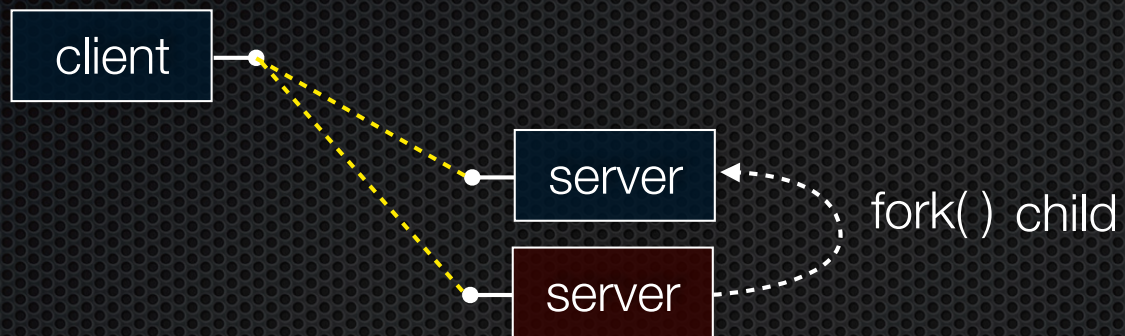

Graphically

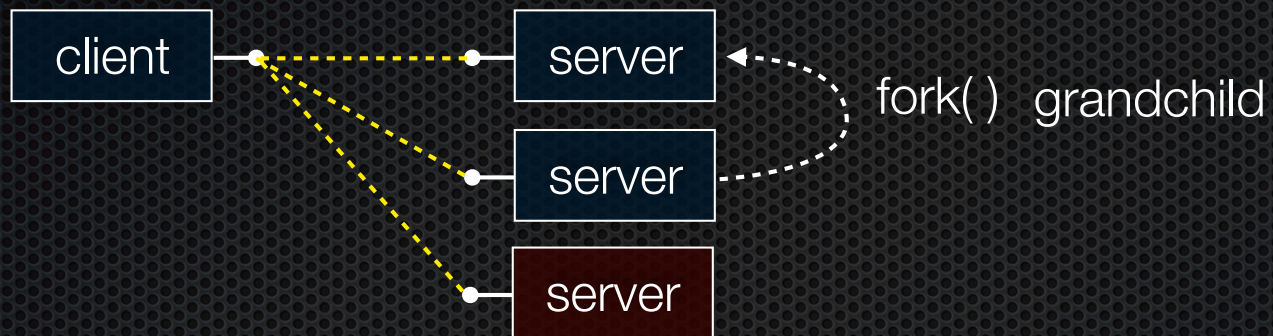

Graphically

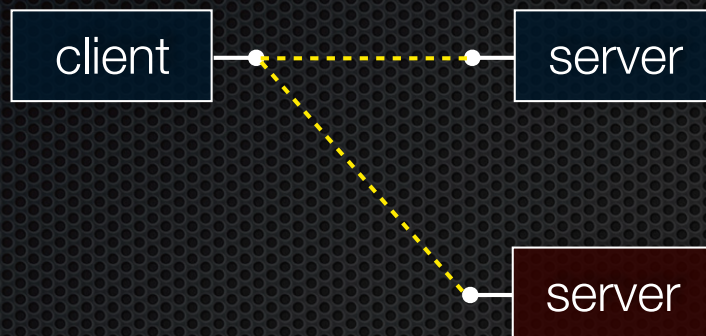

child `exit()`'s / parent `wait()`'s

Graphically

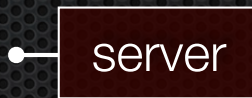

parent closes its
client connection

Graphically

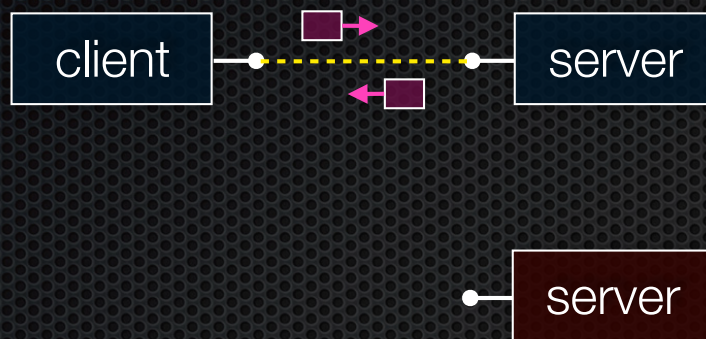

Graphically

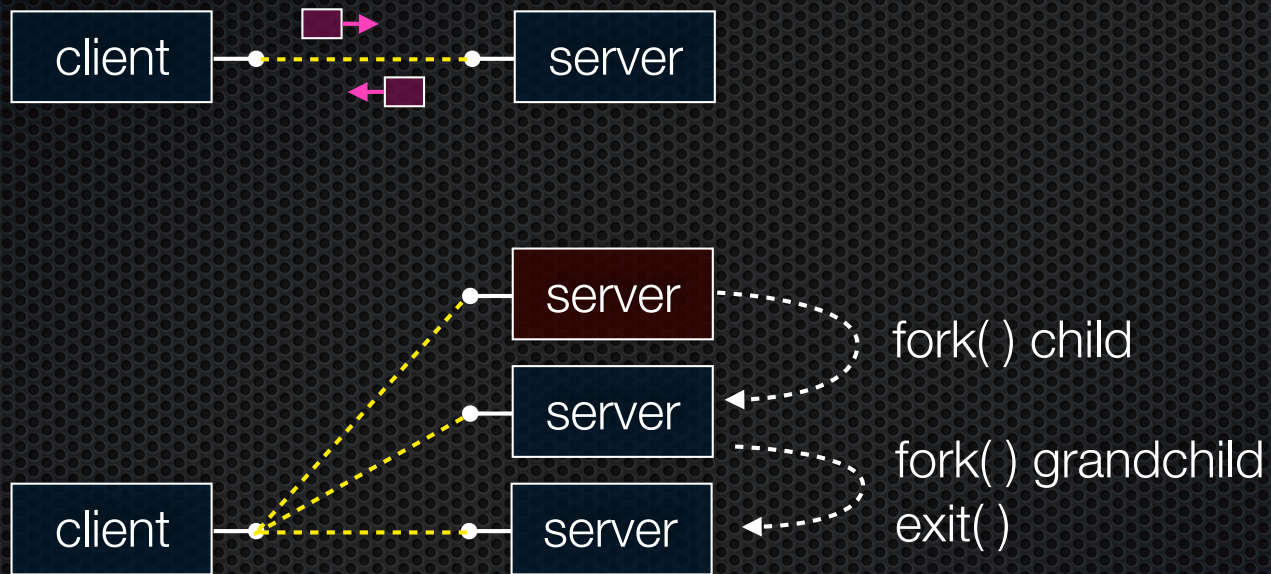

Graphically

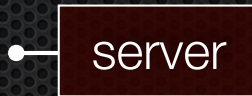

Graphically

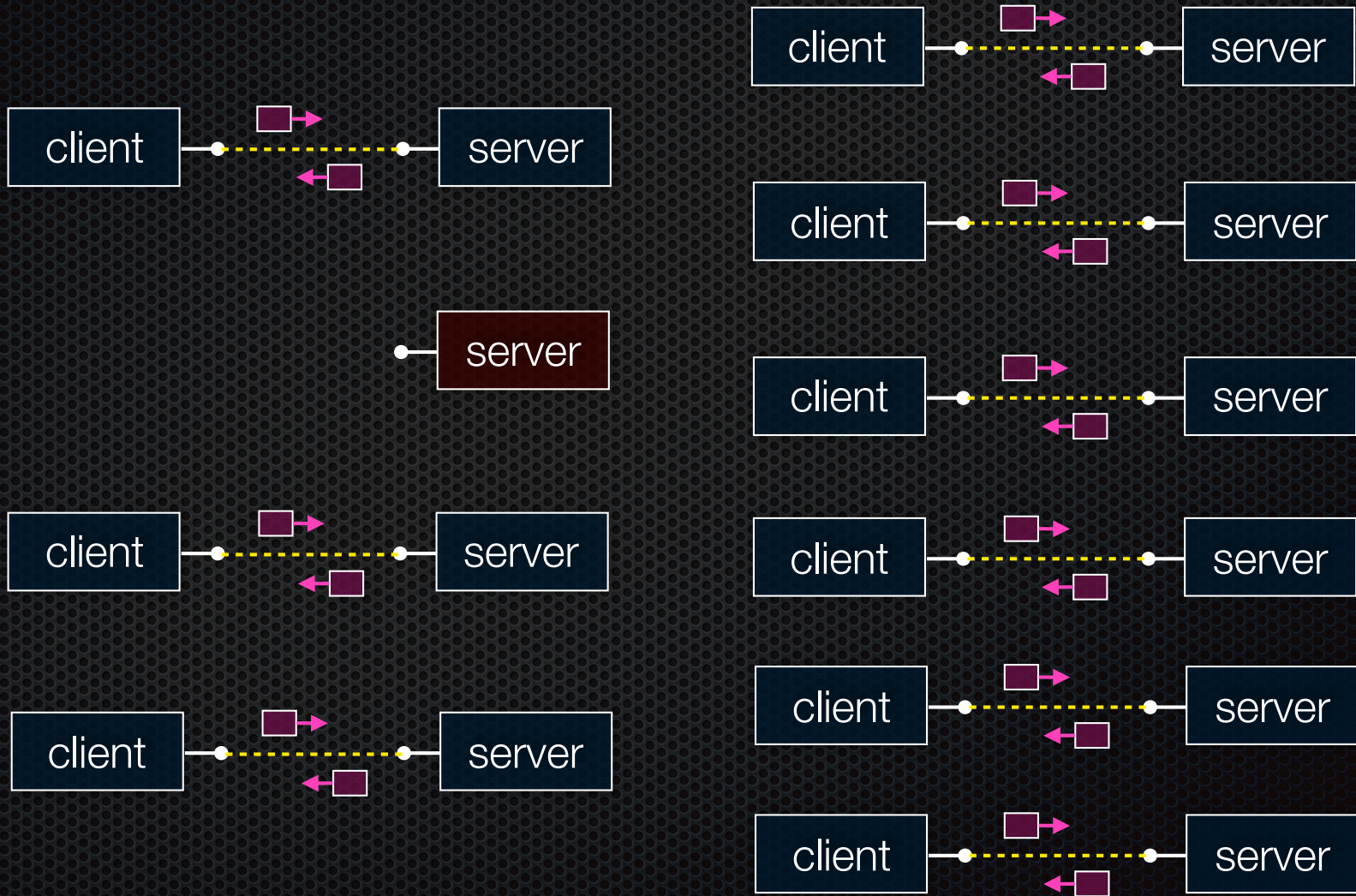

Concurrent with processes

*look at **searchserver_processes***

Whither concurrent processes?

Benefits

- almost as simple as sequential
 - ▶ in fact, most of the code is identical!
- parallel execution; good CPU, network utilization

Disadvantages

- processes are heavyweight
 - ▶ relatively slow to fork
 - ▶ context switching latency is high
- communication between processes is complicated

How slow is fork?

*run **forklatency.cc***

Implications?

0.25 ms per fork

- maximum of $(1000 / 0.25) = 4,000$ connections per second per core
- ~0.5 billion connections per day per core
 - ▶ fine for most servers
 - ▶ too slow for a few super-high-traffic front-line web services
 - Facebook serves $O(750 \text{ billion})$ page views per day
 - would need 3,000 -- 6,000 cores just to handle `fork()`, i.e., without doing any work for each connection!

threads

Threads are like lightweight processes

- like processes, they execute concurrently
 - ▶ multiple threads can run simultaneously on multiple cores/CPU's
- unlike processes, threads cohabit the same address space
 - ▶ the threads within a process see the same heap and globals
 - threads can communicate with each other through variables
 - but, threads can interfere with each other: need synchronization
 - ▶ each thread has its own stack

threads and the address space

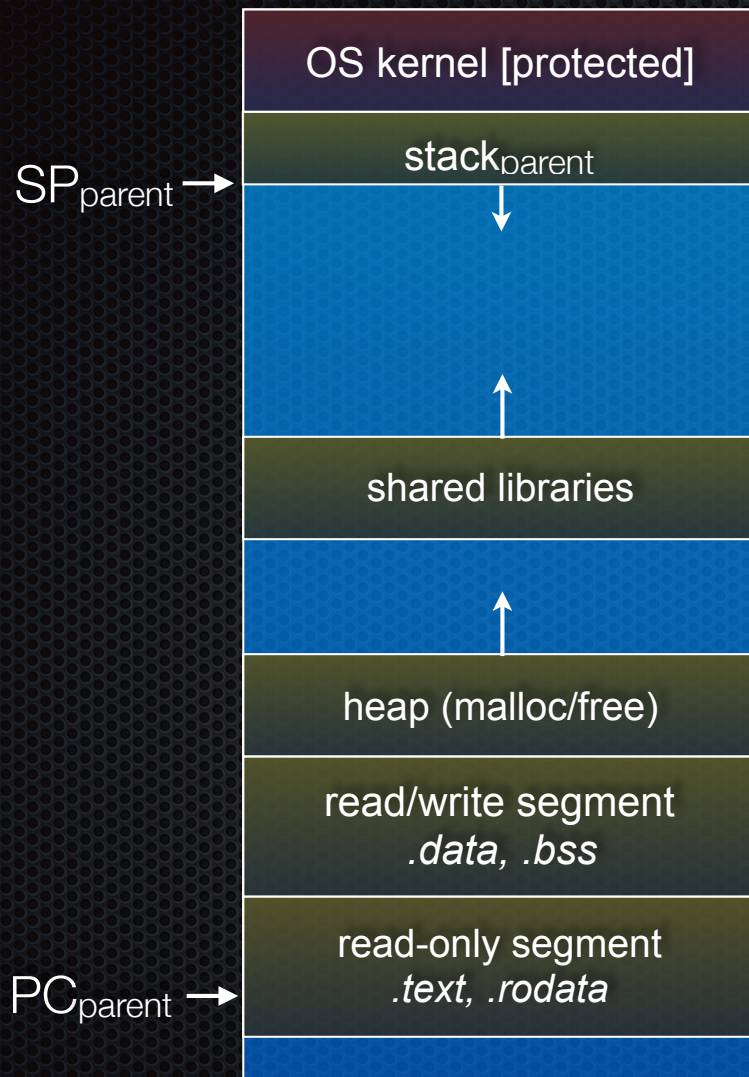

Pre- thread create

- one thread of execution running in the address space
 - ▶ the “main” thread
 - ▶ therefore, one stack, SP, PC
- that main thread invokes a function to create a new thread
 - ▶ typically “pthread_create()”

threads and the address space

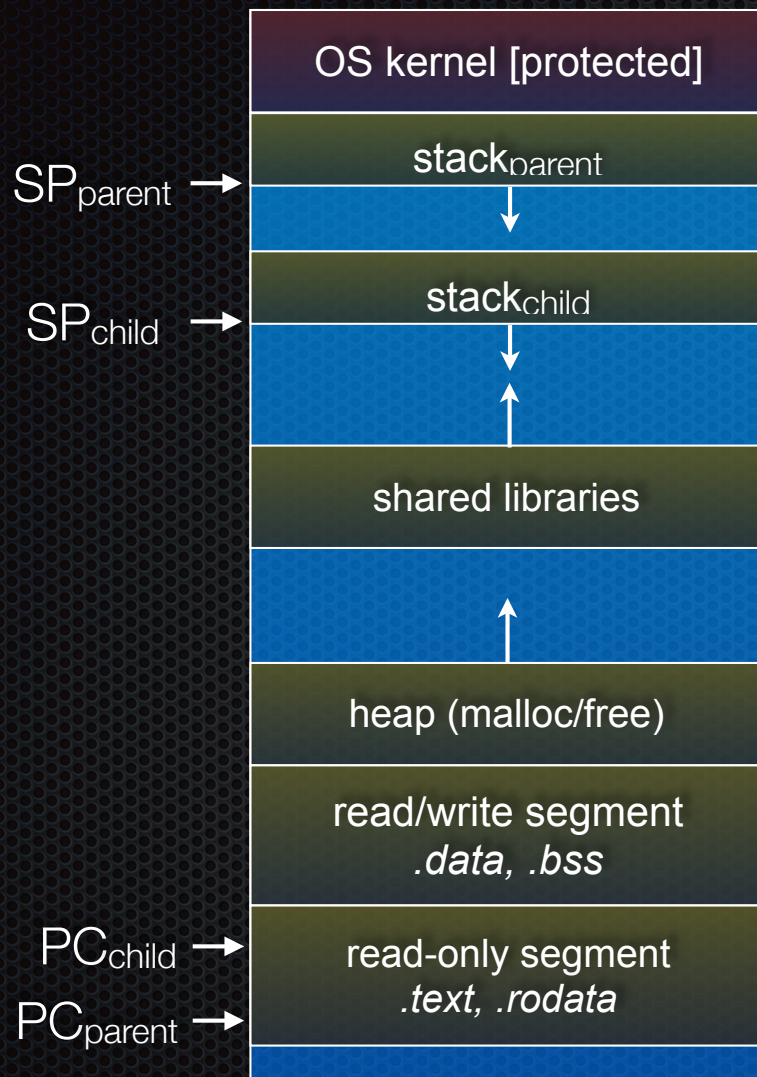

Post- thread create

- two threads of execution running in the address space
 - ▶ the “main” thread (parent)
 - ▶ the child thread
 - ▶ thus, two stacks, SPs, PCs
- both threads share the heap and text segment (globals)
 - ▶ they can cooperatively modify shared data

threads

see `thread_example.cc`

Concurrent server with threads

A single **process** handles all of the connections

- but, a parent **thread** forks (or dispatches) a new thread to handle each connection
- the child thread:
 - ▶ handles the new connection
 - ▶ exits when the connection terminates

Graphically

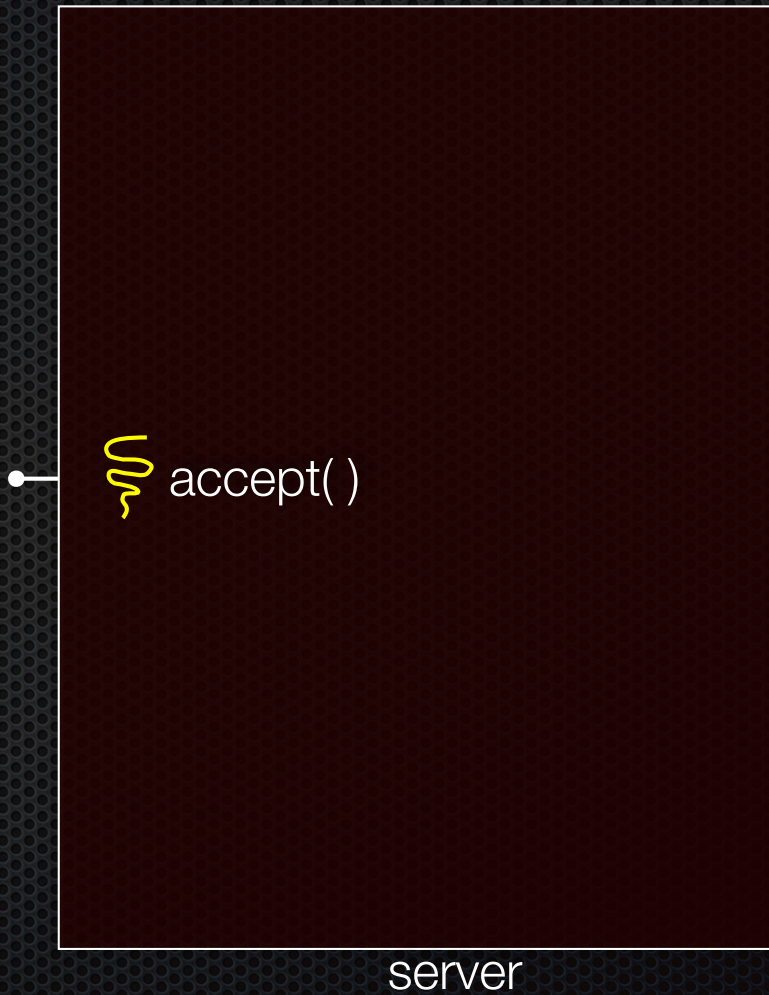

Graphically

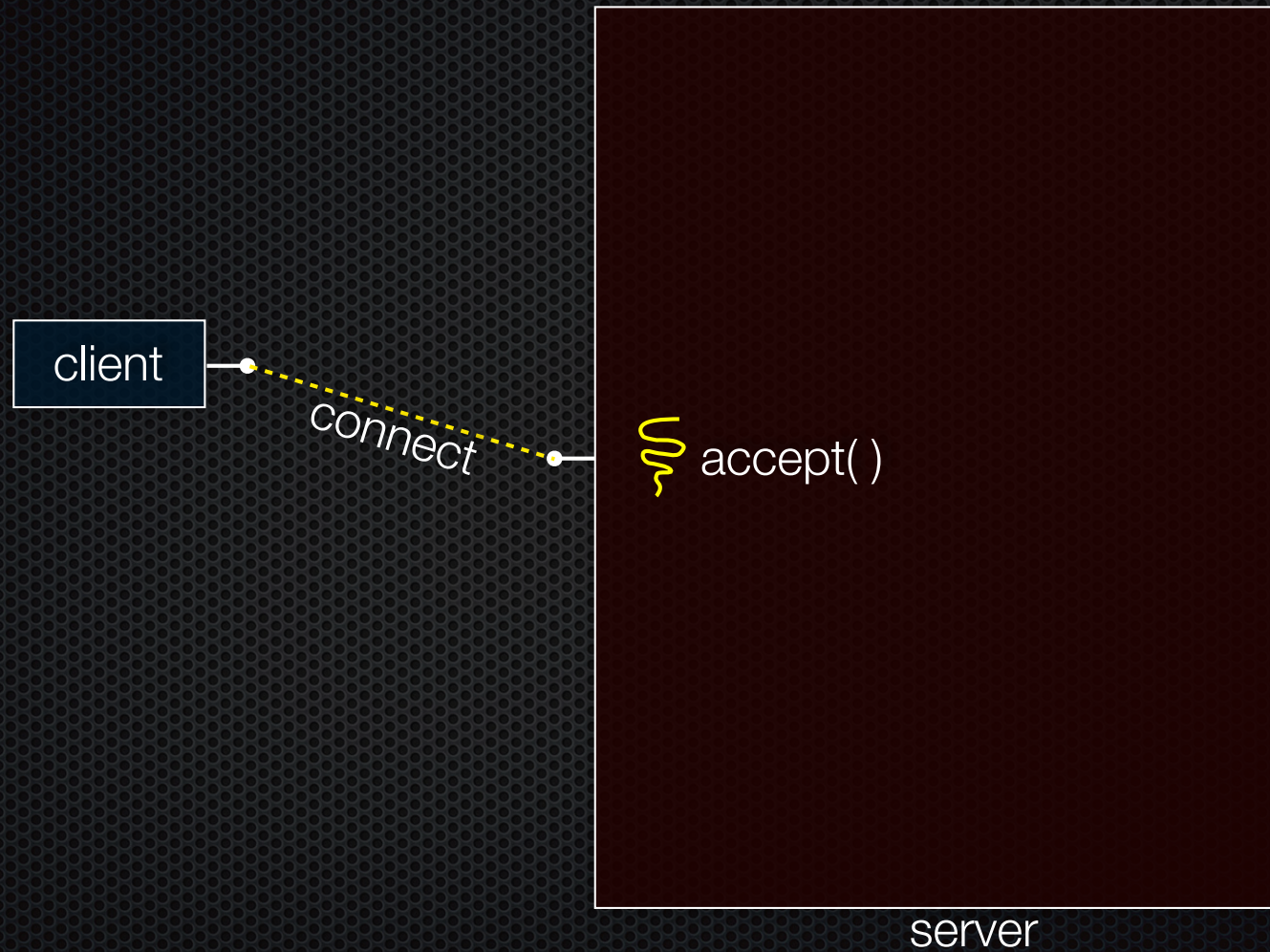

Graphically

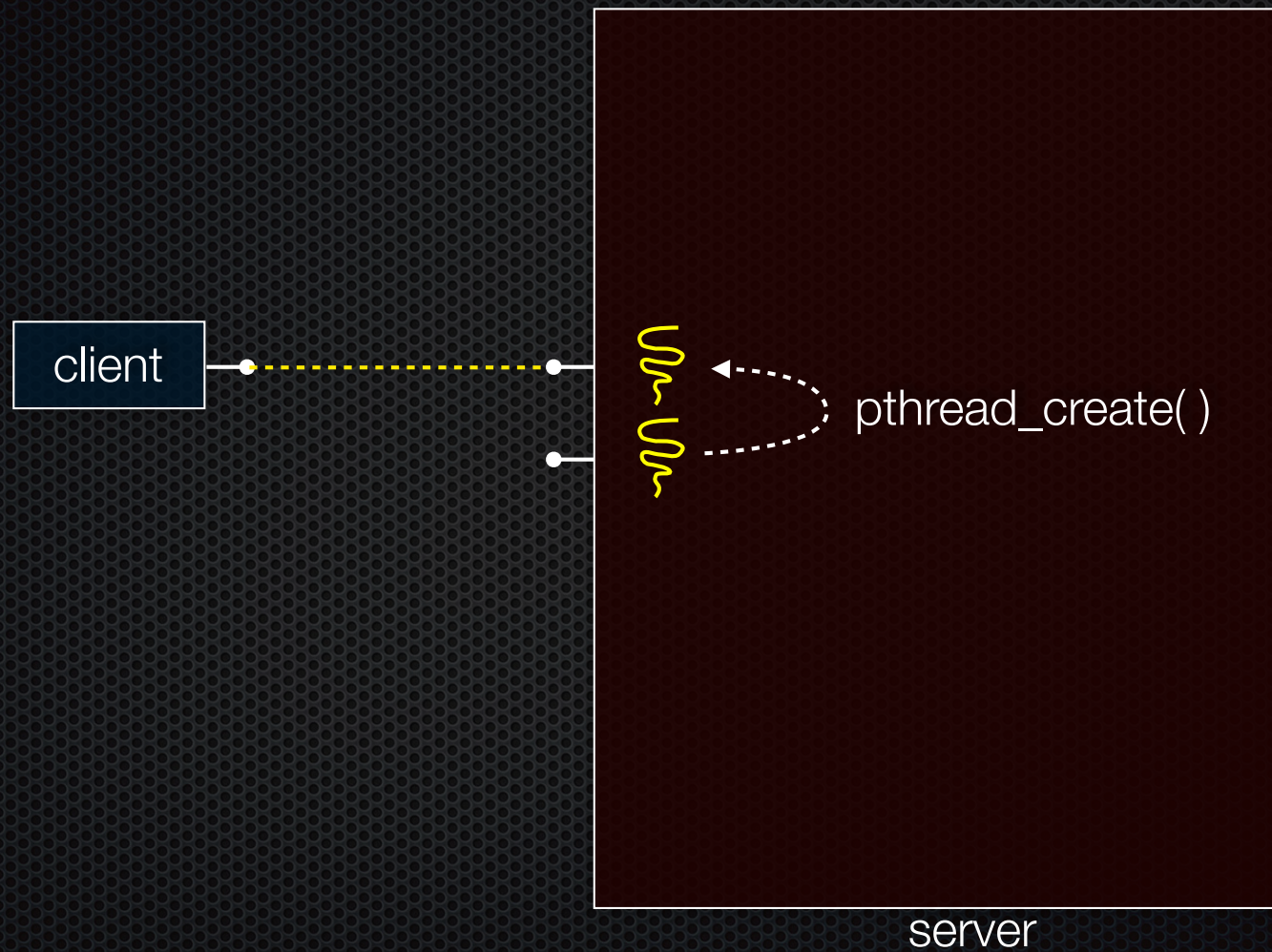

Graphically

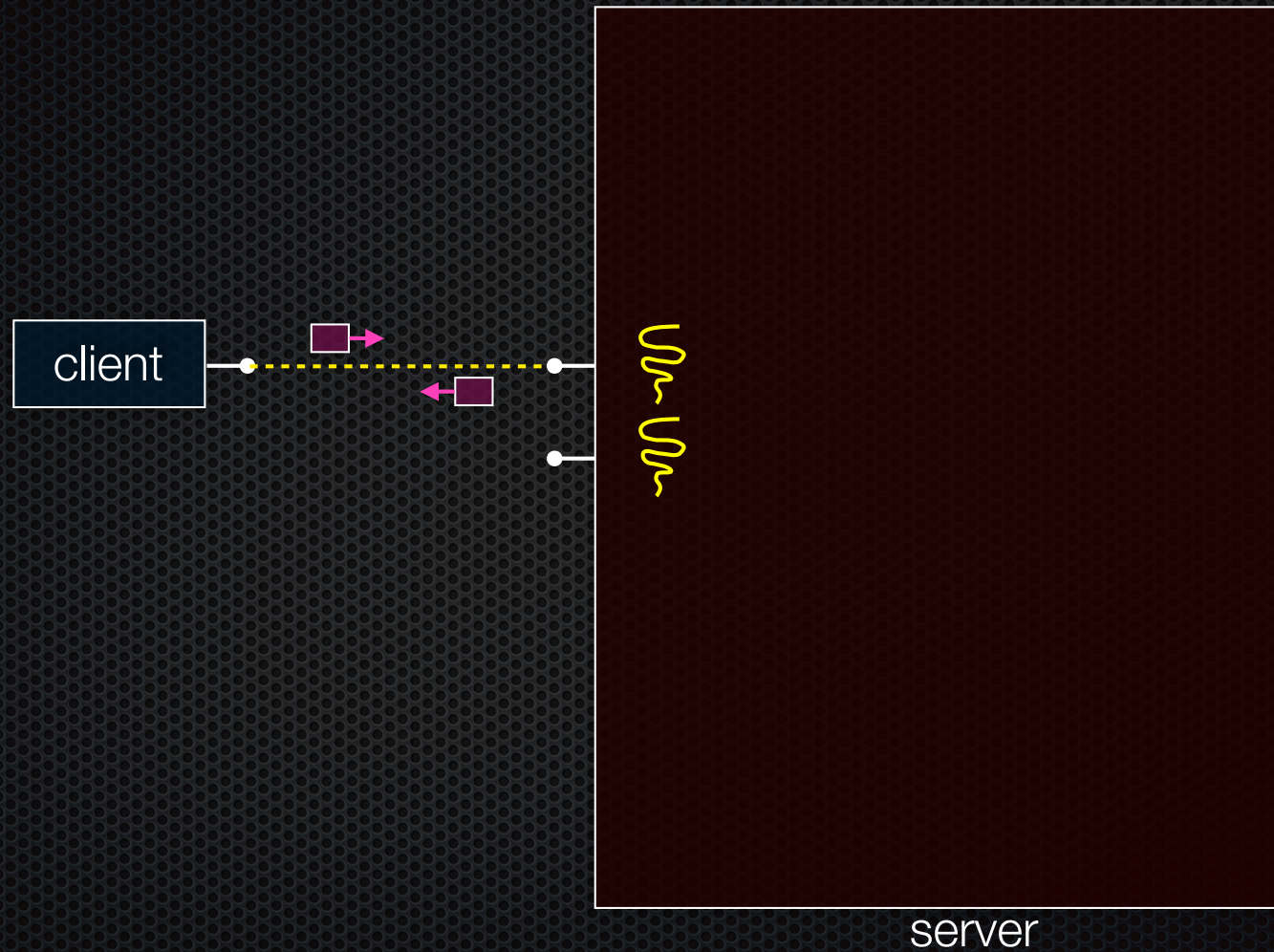

Graphically

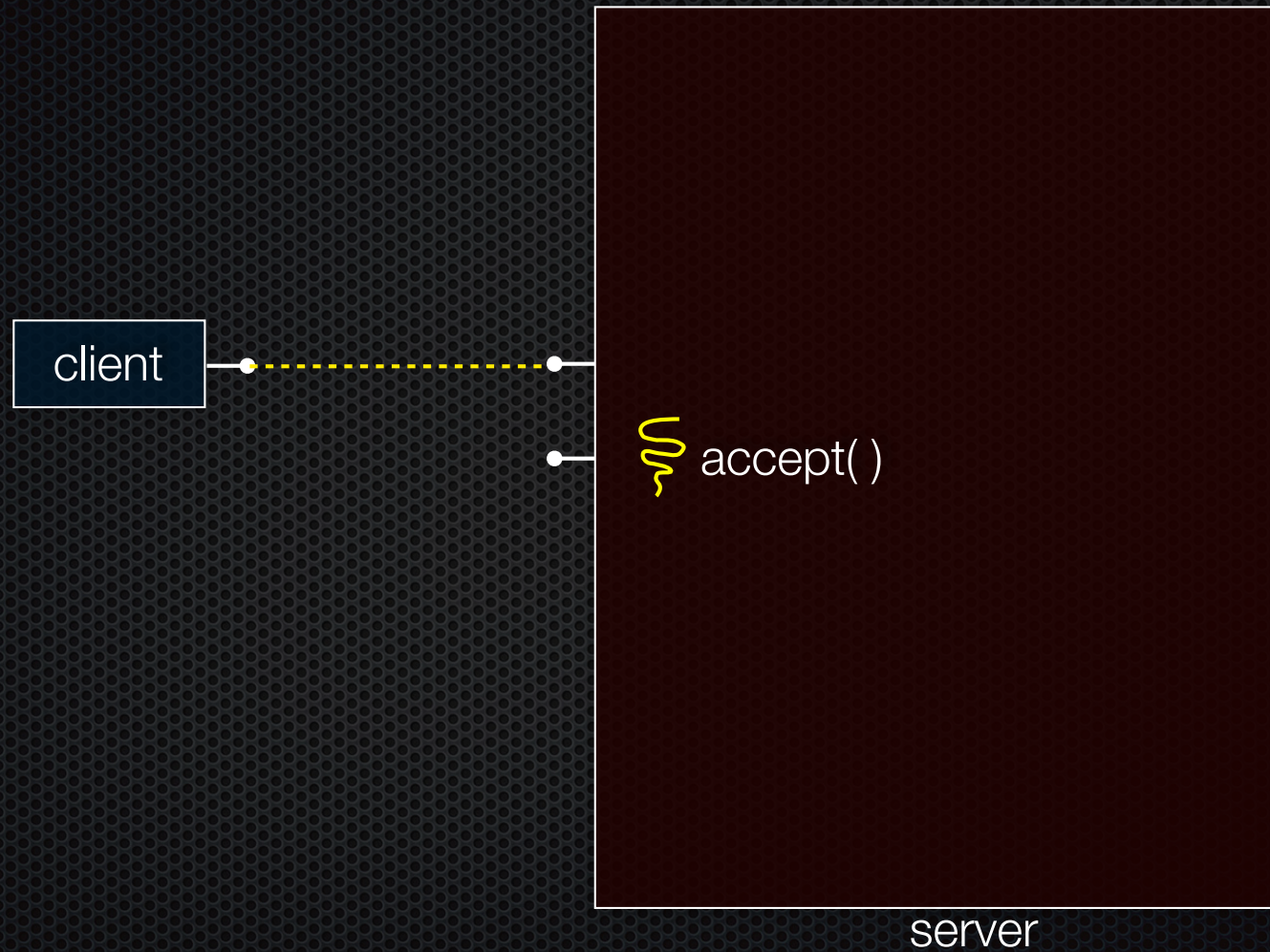

Graphically

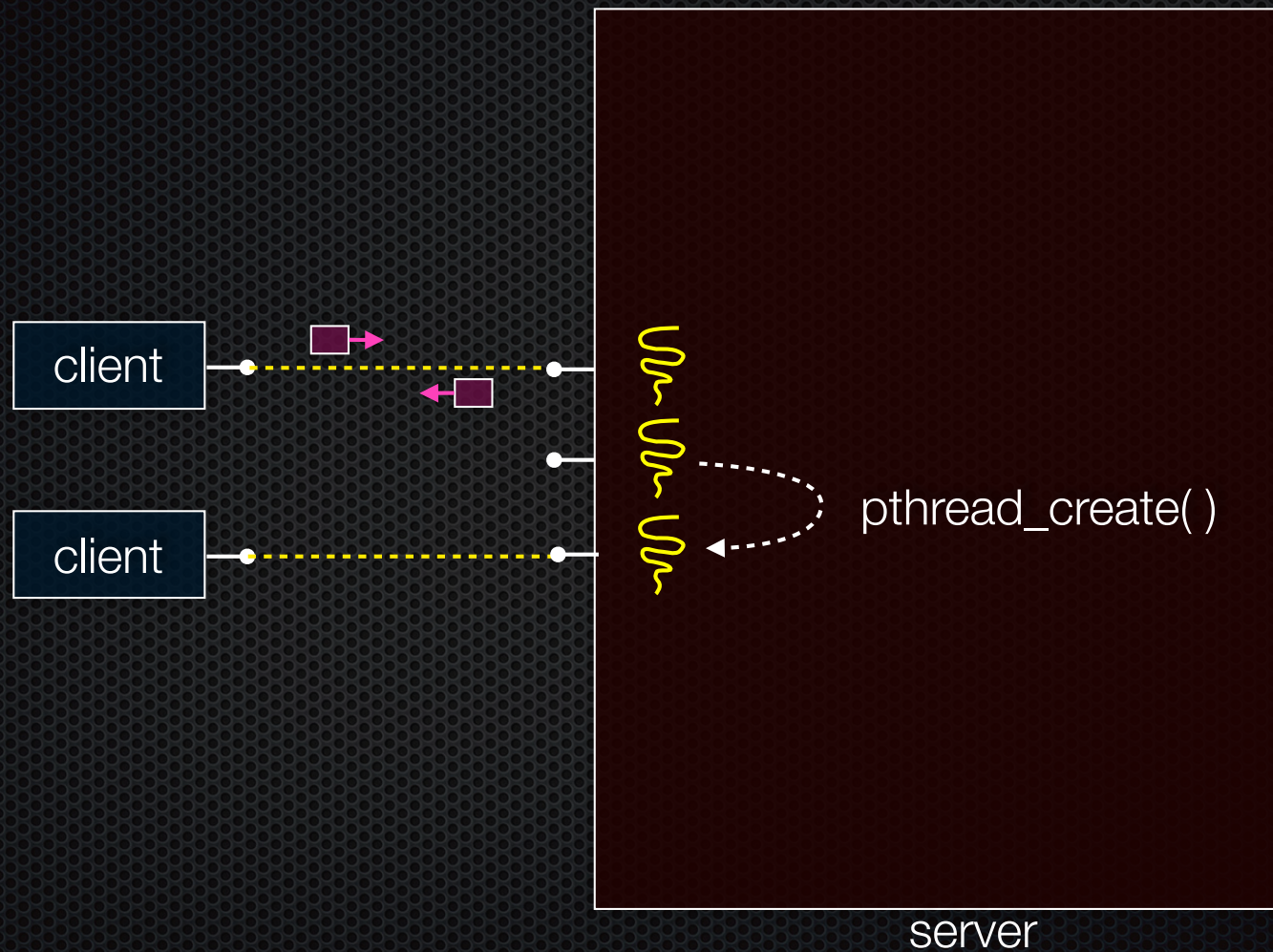

Graphically

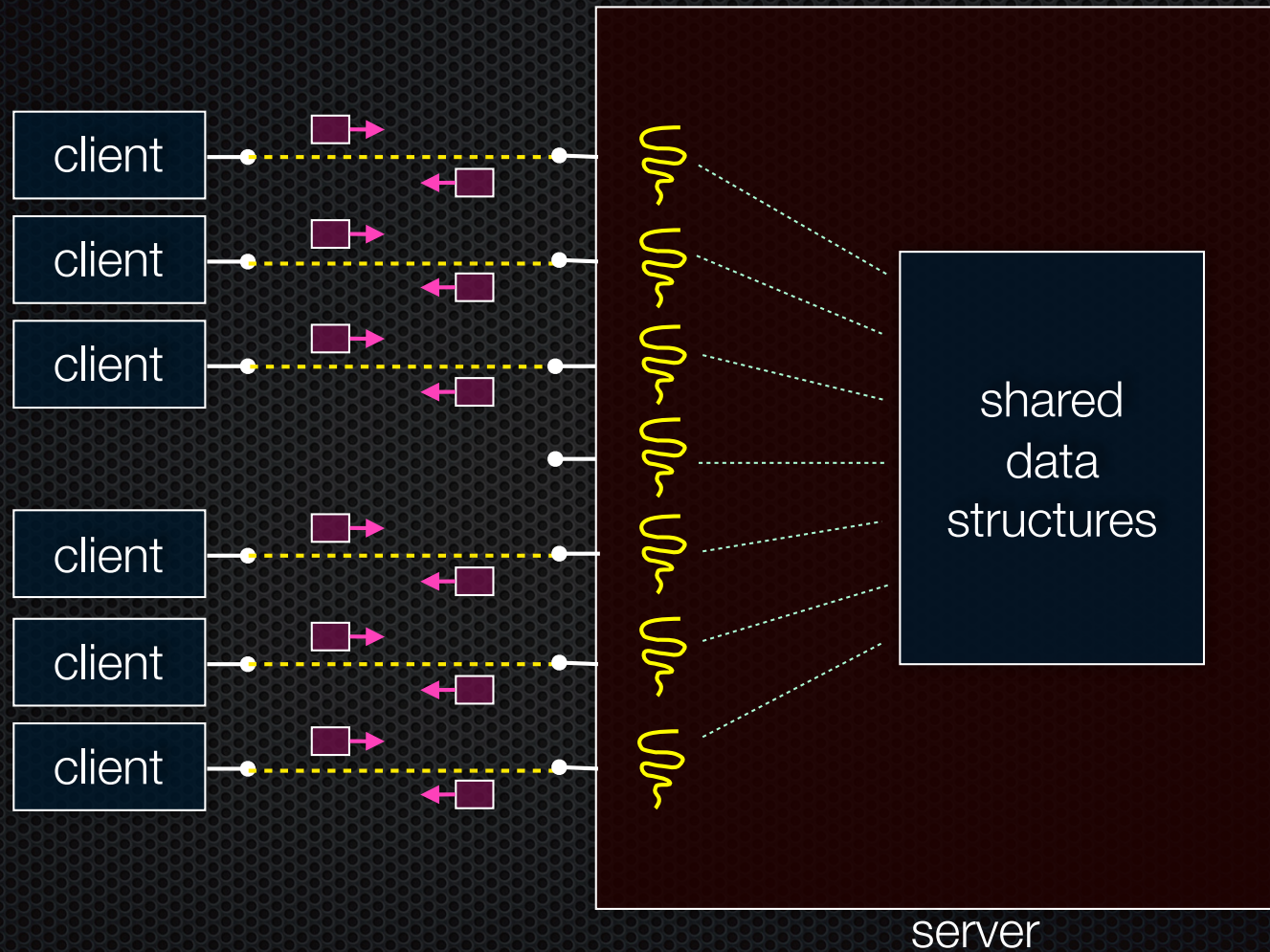

Concurrent with threads

*look at **searchserver_threads/***

Whither concurrent threads?

Benefits

- straight-line code
 - ▶ still the case that much of the code is identical to sequential!
- parallel execution; good CPU, network utilization
 - ▶ lower overhead than processes
- shared-memory communication is possible

Disadvantages

- **synchronization** is complicated
- shared fate within a process; one rogue thread can hurt you badly

How fast is `pthread_create`?

*run **threadlatency.cc***

Implications?

0.036 ms per thread create; ~10x faster than process forking

- maximum of $(1000 / 0.018) = \sim 60,000$ connections per second
- ~10 billion connections per day per core
 - ▶ much better

But, writing safe multithreaded code can be serious voodoo

Thread Pools

In real servers we'd like to avoid overhead needed to create a new thread or process for every request

Idea: thread pools

- Create a set of worker threads or processes on server startup, put them in a queue
- When a request arrives, remove the first worker thread from the queue and assign it to handle the request
- When a worker is done it places itself back on the queue and then sleeps until dequeued and handed a new request

Threads and races

What happens if two threads try to mutate the same data structure?

- they might interfere in painful, non-obvious ways, depending on the specifics of the data structure
 - ▶ imagine if two threads try to push an item onto the head of the linked list at the same time
 - ▶ depending on how the threads interleave, you might end up with a correct answer, or you might break the data structure altogether

Simple “race” example

If no milk, buy some more

- liveness: if out, somebody buys
- safety: at most one person buys

What happens with multiple threads?

```
if (!milk) {  
    buy milk  
}
```

Simple “race” example

Does this fix the problem?

```
if (!note) {  
    if (!milk) {  
        leave note  
        buy milk  
        remove note  
    }  
}
```

Synchronization

Synchronization is the act of preventing two (or more) concurrently running threads from interfering with each other when operating on shared data

- need some mechanism to coordinate the threads
 - ▶ “let me go first, then you go”
- many different coordination mechanisms have been invented
 - ▶ take cse451 for details

Locks

lock acquire

- wait until the lock is free, then take it

lock release

- release the lock
- if other threads are waiting for it
 - ▶ wake up exactly one of them
 - ▶ give it the lock

simplifies concurrent code

- prevents more than one thread from entering a *critical section*

```
... non-critical code ...  
lock.acquire() ;  
    critical section  
lock.release() ;  
... non-critical code ...
```

Simple “race” solution

What is the critical section?

- checking for milk
- buying more milk if out

These two steps must be uninterrupted, i.e., **atomic**

- solution: protect the critical section with a lock

```
milk_lock.lock()

if (!milk) {
    buy milk
}

milk_lock.unlock()
```

pthread and locks

pthread_mutex_init()

- creates a mutex (a.k.a. a lock)

pthread_mutex_lock()

- grabs the lock

pthread_mutex_unlock()

- releases the lock

see ***lock_example.cc***

C++ 11 Threads

C++ 11 added threads and concurrency to the libraries

- `<thread>` - thread objects
- `<mutex>` - locks to handle critical sections
- `<condition_variable>` - used to block objects until notified to resume
- `<atomic>` - indivisible, atomic operations
- `<future>` - asynchronous access to data

Might be built on top of `<pthread.h>`, maybe not

Definitely use in C++ 11 code, but `pthread` will still be around for a long, long time

Exercise 1

Write a simple “proxy” server

- forks a process for each connection
- reads an HTTP request from the client
 - ▶ relays that request to `www.cs.washington.edu`
- reads the response from `www.cs.washington.edu`
 - ▶ relays the response to the client, closes the connection

Try visiting your proxy using a web browser :)

Exercise 2

Write a client program that:

- loops, doing “requests” in a loop. Each request must:
 - ▶ connect to one of the echo servers from the lecture
 - ▶ do a network exchange with the server
 - ▶ close the connection
- keeps track of the latency (time to do a request) distribution
- keeps track of the throughput (requests / s)
- prints these out

See you on Wednesday !