

CSE 333

Lecture 16 -- networks

Hal Perkins

Paul G. Allen School of Computer Science & Engineering

University of Washington

Administrivia

Midterms “returned” via gradescope last week

- Everyone able to get theirs?
- Use gradescope links if you have regrade questions

Check the course gradebook to be sure all grades (including midterm and late days) are correct

HW3 due Thursday night

Today - overview of networking

Then - client-side and server-side TCP sockets

Rest of the quarter

HW4 out Friday; due last Thursday of the quarter (plus late days if you have & need them)

A few more exercises, but nothing due until next Mon.

Final exam in scheduled slot, Wed. Dec. 13, 2:30-4:20

- Should we schedule a review Q&A late Tue. Dec. 12?

Networks from 10,000ft

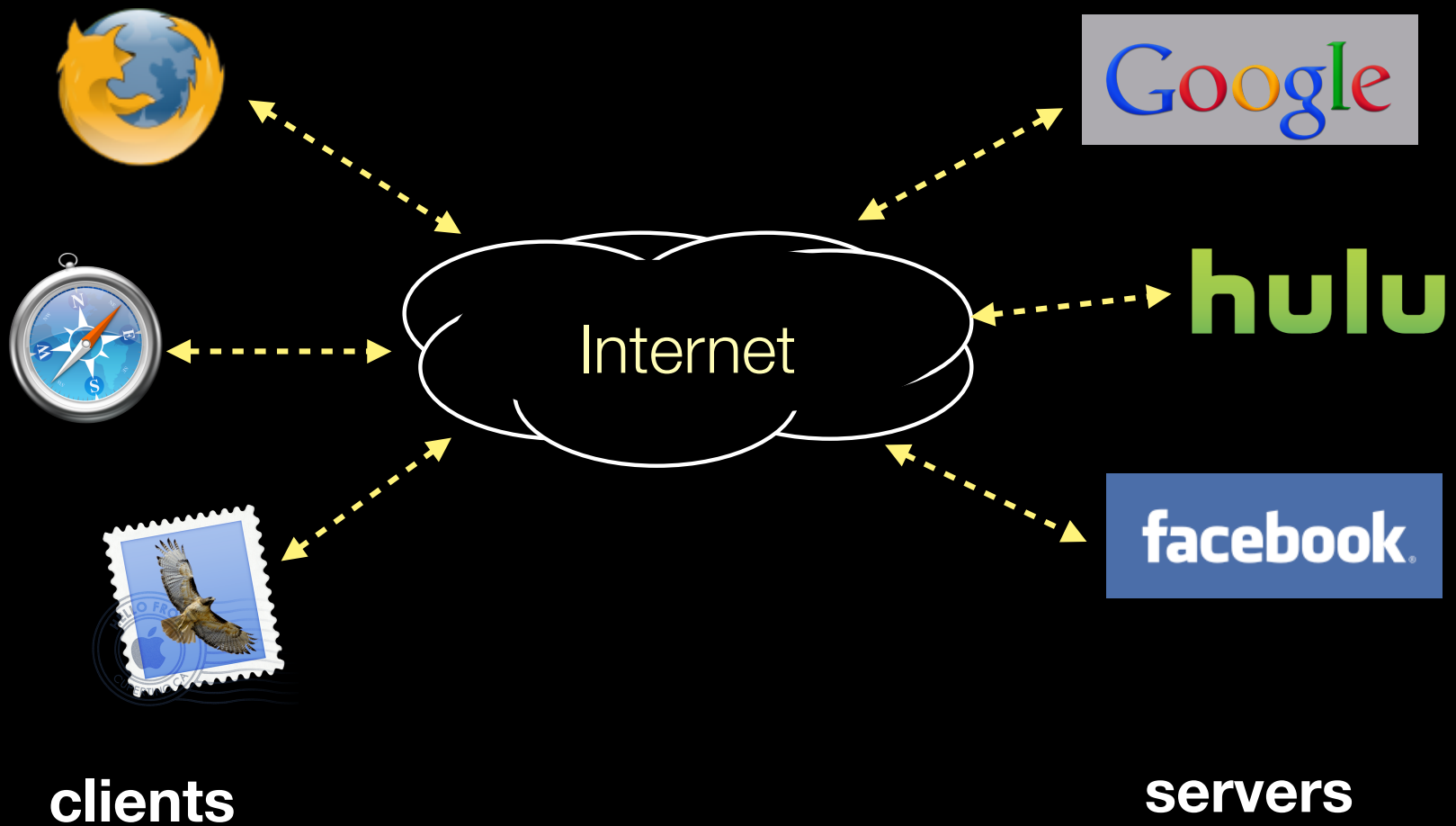

The “physical” layer

Individual bits are modulated onto a wire or transmitted over radio

- ▶ physical layer specifies how bits are encoded at a signal level
- ▶ e.g., a simple spec would encode “1” as +1V, “0” as -1V

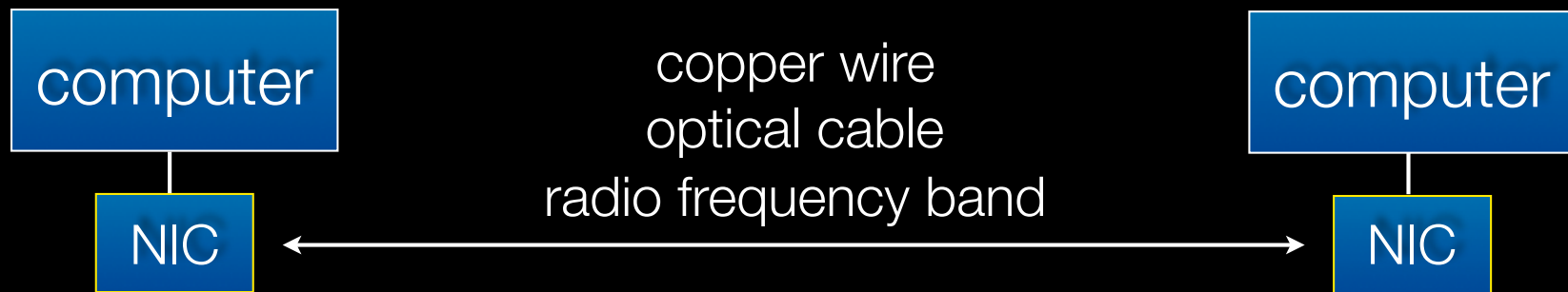
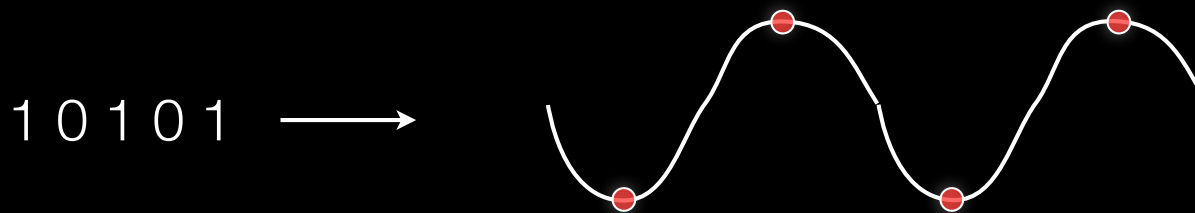

The “data link” layer

Multiple computers on a LAN contend for the network medium

- ▶ media access control (MAC) specifies how computers cooperate
- ▶ link layer also specifies how bits are packetized and NICs are addressed

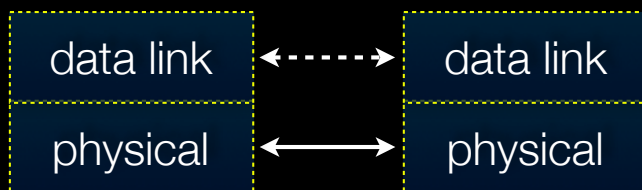
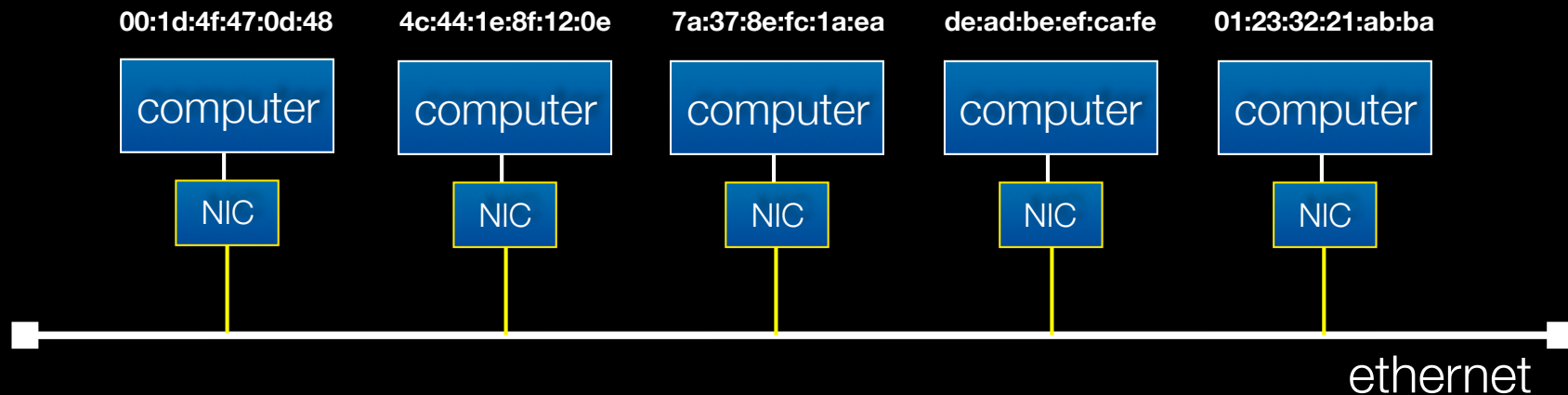

The “network” layer (IP)

The Internet Protocol (IP) routes packets across multiple networks

- ▶ every computer has a unique Internet address (IP address)
- ▶ individual networks are connected by routers that span networks

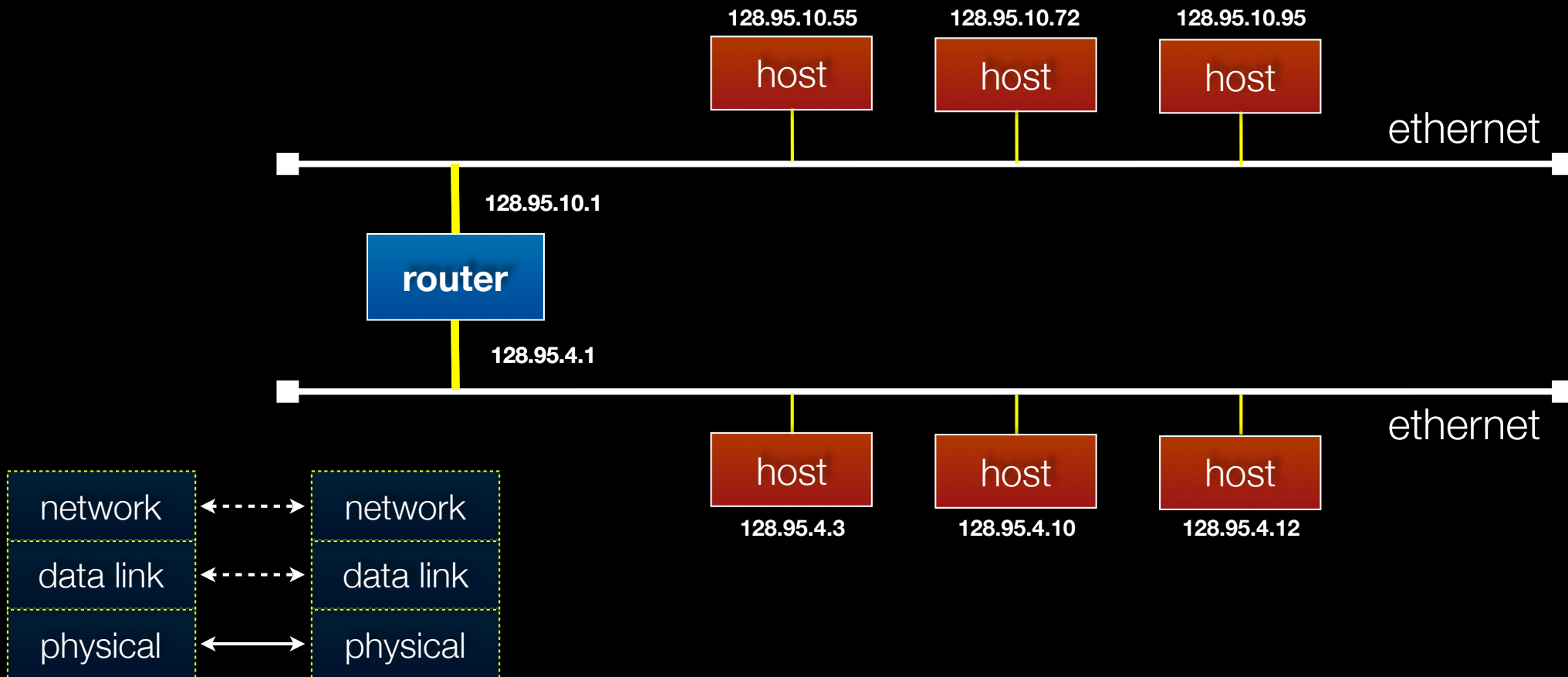

The “network” layer (IP)

Protocols to:

- ▶ let a host find the MAC address of an IP address on the same network
- ▶ let a router learn about other routers and figure out how to get IP packets one step closer to their destination

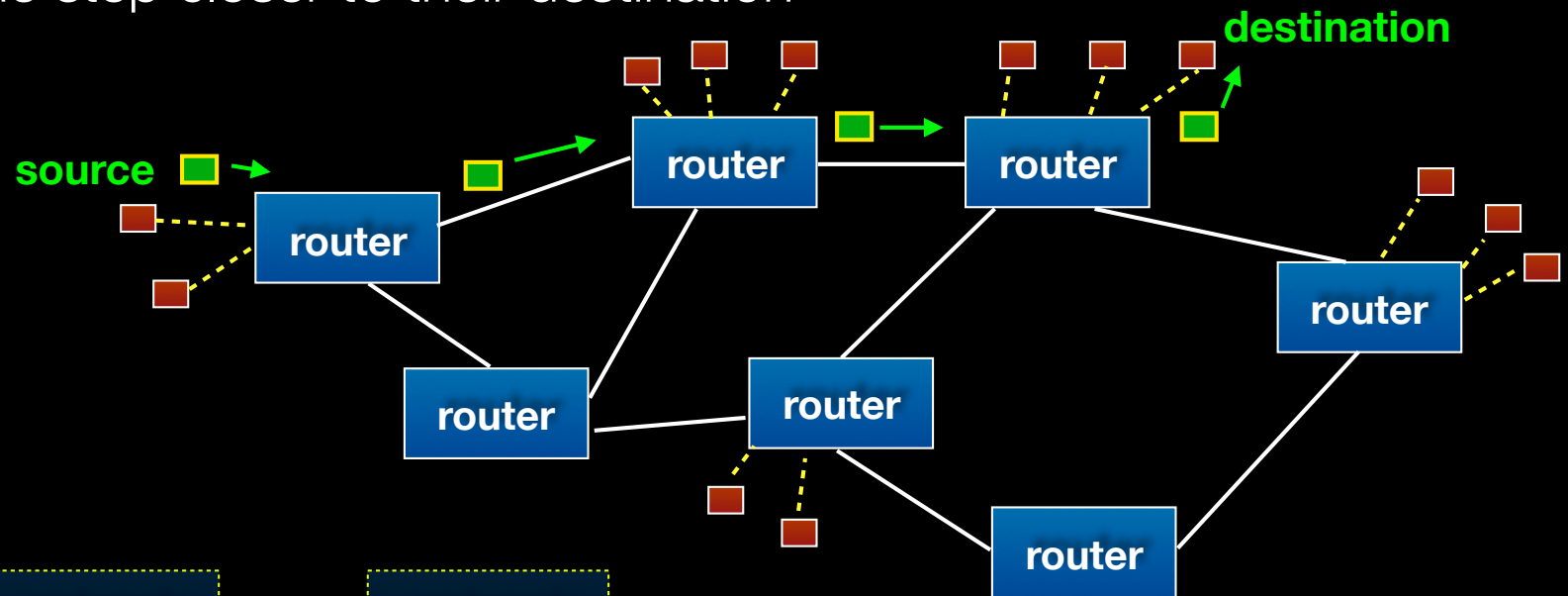

The “network” layer (IP)

Packet encapsulation

- ▶ an IP packet is encapsulated as the payload of an Ethernet frame
- ▶ as IP packets traverse networks, routers pull out the IP packet from an ethernet frame and plunk it into a new one on the next network

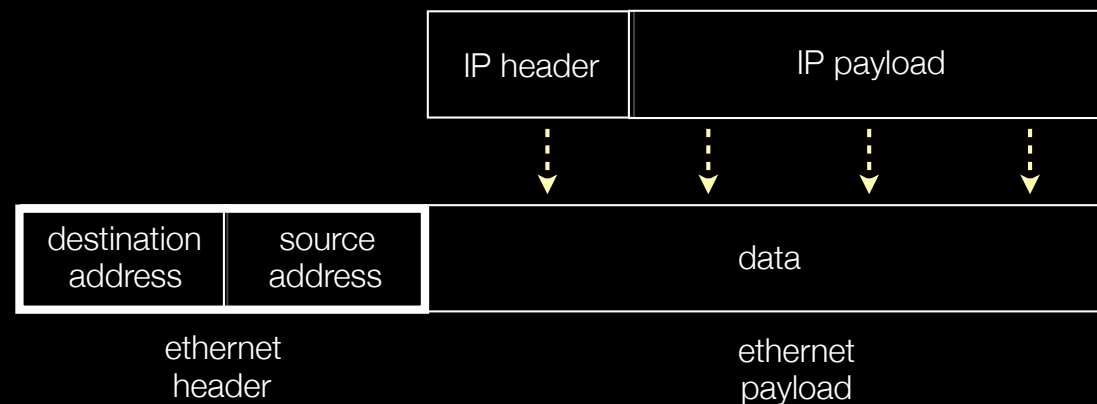

The “transport” layer (TCP, UDP)

TCP

- the “transmission control protocol”
- provides apps with reliable, ordered, congestion-controlled byte streams
- fabricates them by sending multiple IP packets, using sequence numbers to detect missing packets, and retransmitting them
- a single host (IP address) can have up to 65,535 “ports”
 - kind of like an apartment number at a postal address

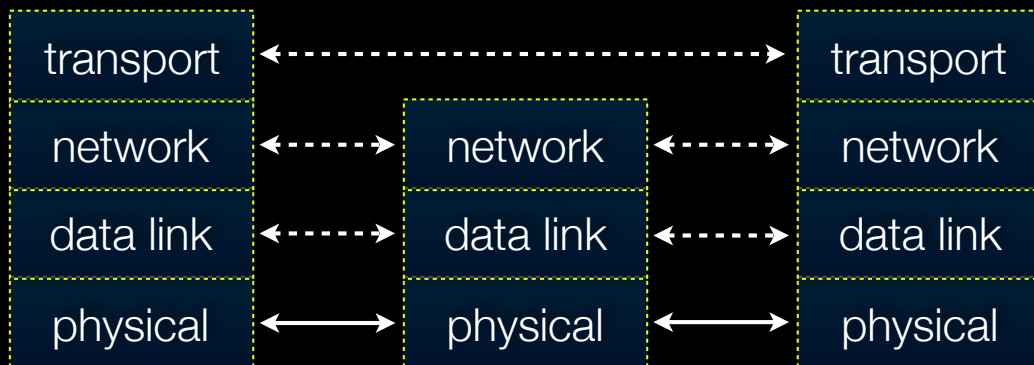

The “transport” layer (TCP, UDP)

TCP

- ▶ useful analogy: how would you send a book by mail via postcards?
- ▶ split the book into multiple postcards, send each one by one, including sequence numbers that indicate the assembly order
- ▶ receiver sends back postcards to acknowledge receipt and indicate which got lost in the mail

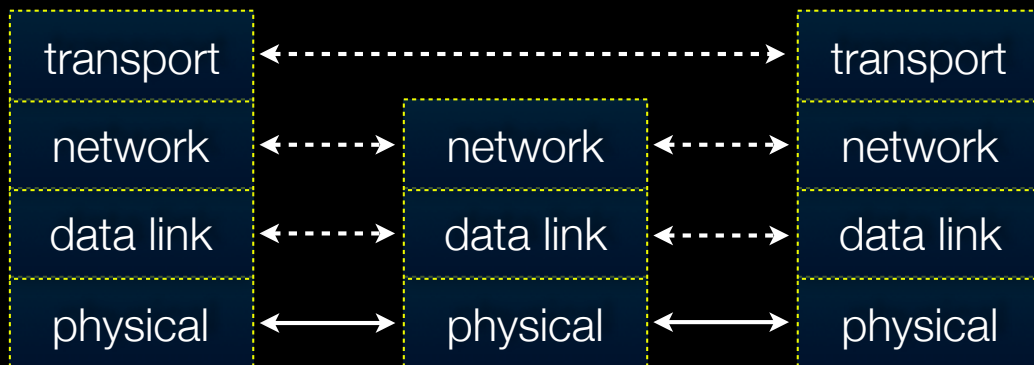

The “transport” layer (TCP)

Packet encapsulation -- same as before!

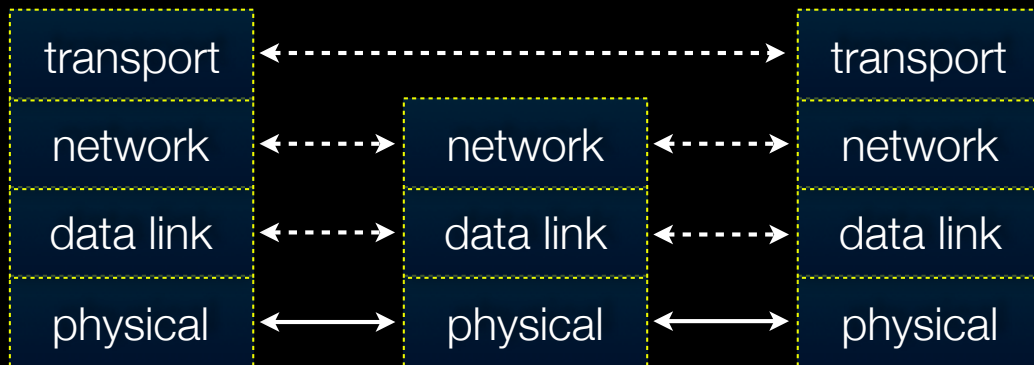
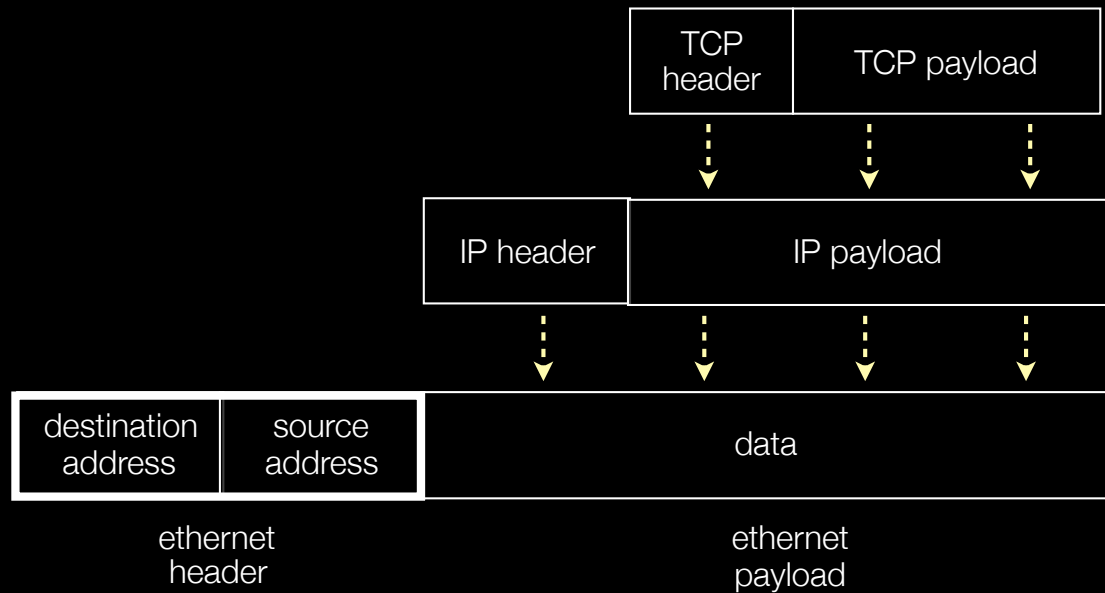

The “transport” layer (TCP)

Applications use OS services to establish TCP streams

- ▶ the “Berkeley sockets” API -- a set of OS system calls
- ▶ clients **connect()** to a server IP address + application port number
- ▶ servers **listen()** for and **accept()** client connections
- ▶ clients, servers **read()** and **write()** data to each other

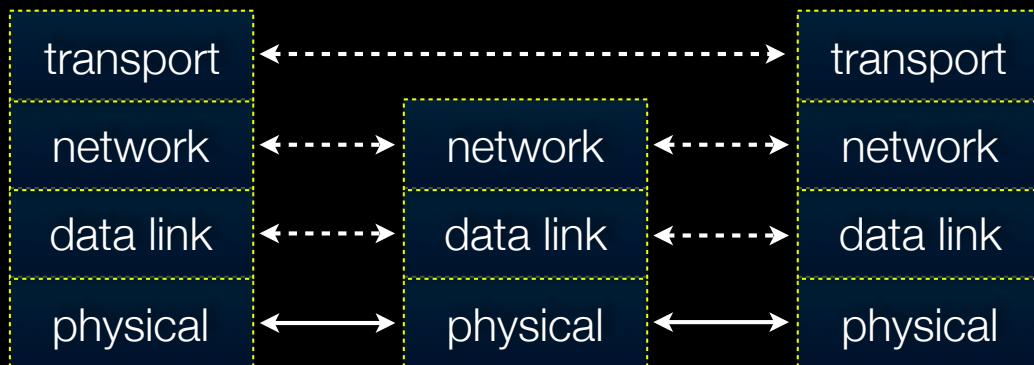

The “transport” layer (UDP)

UDP

- the “user datagram protocol”
- provides apps with unreliable packet delivery
- UDP datagrams are fragmented into multiple IP packets
 - UDP is a really thin, simple layer on top of IP

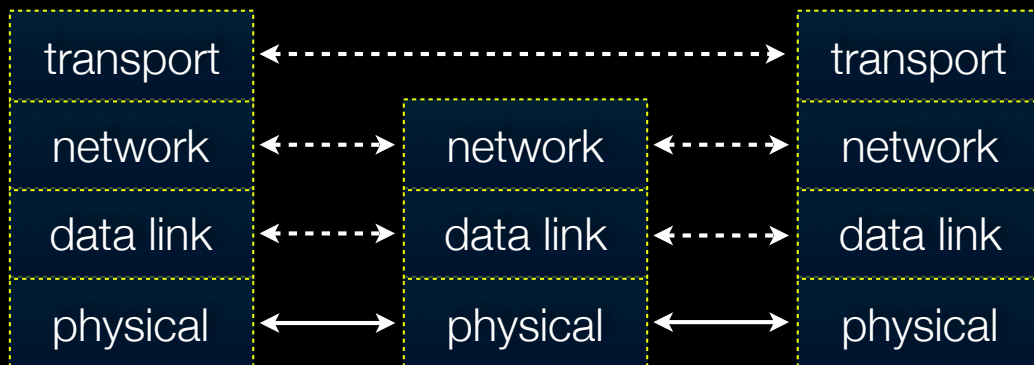

The (mostly missing) layers 5,6

Layer 5: session layer

- ▶ supposedly handles establishing, terminating application sessions
- ▶ RPC kind of fits in here

Layer 6: presentation layer

- ▶ supposedly maps application-specific data units into a more network-neutral representation
- ▶ encryption (SSL) kind of fits in here

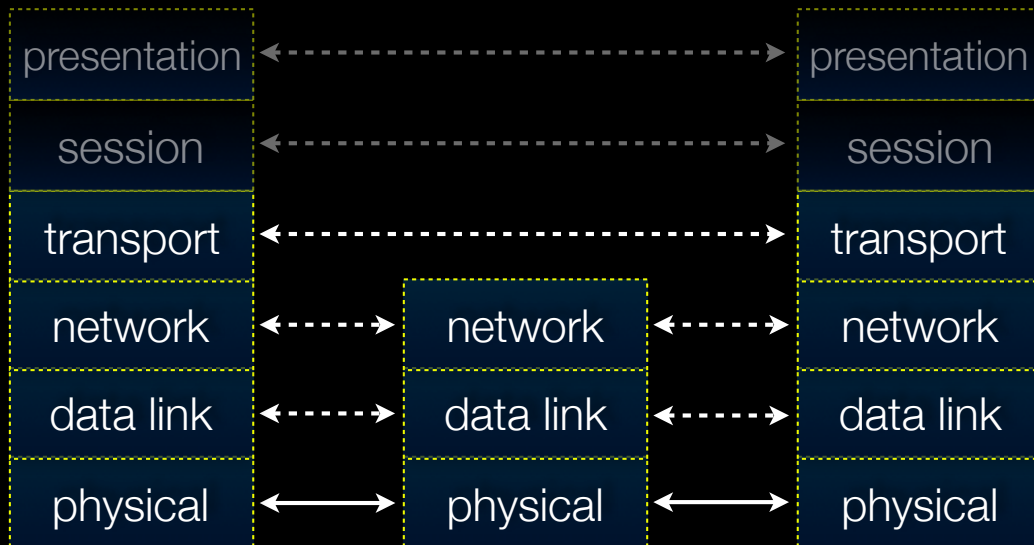

The “application” layer

Application protocols

- the format and meaning of messages between application entities
- e.g., HTTP is an application level protocol that dictates how web browsers and web servers communicate
 - ▶ HTTP is implemented on top of TCP streams

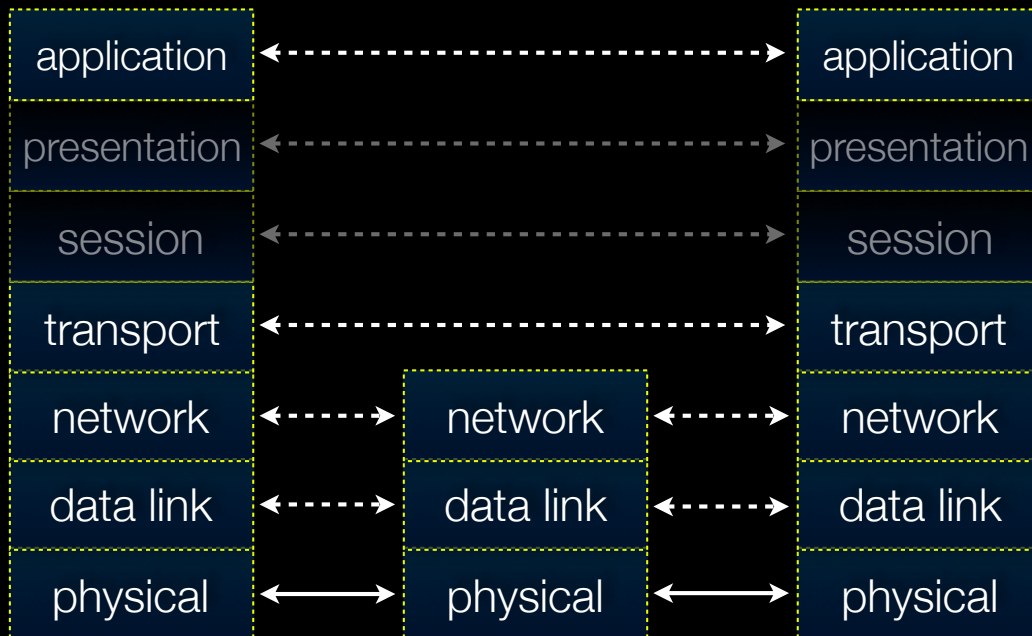

The “application” layer

Packet encapsulation -- same as before!

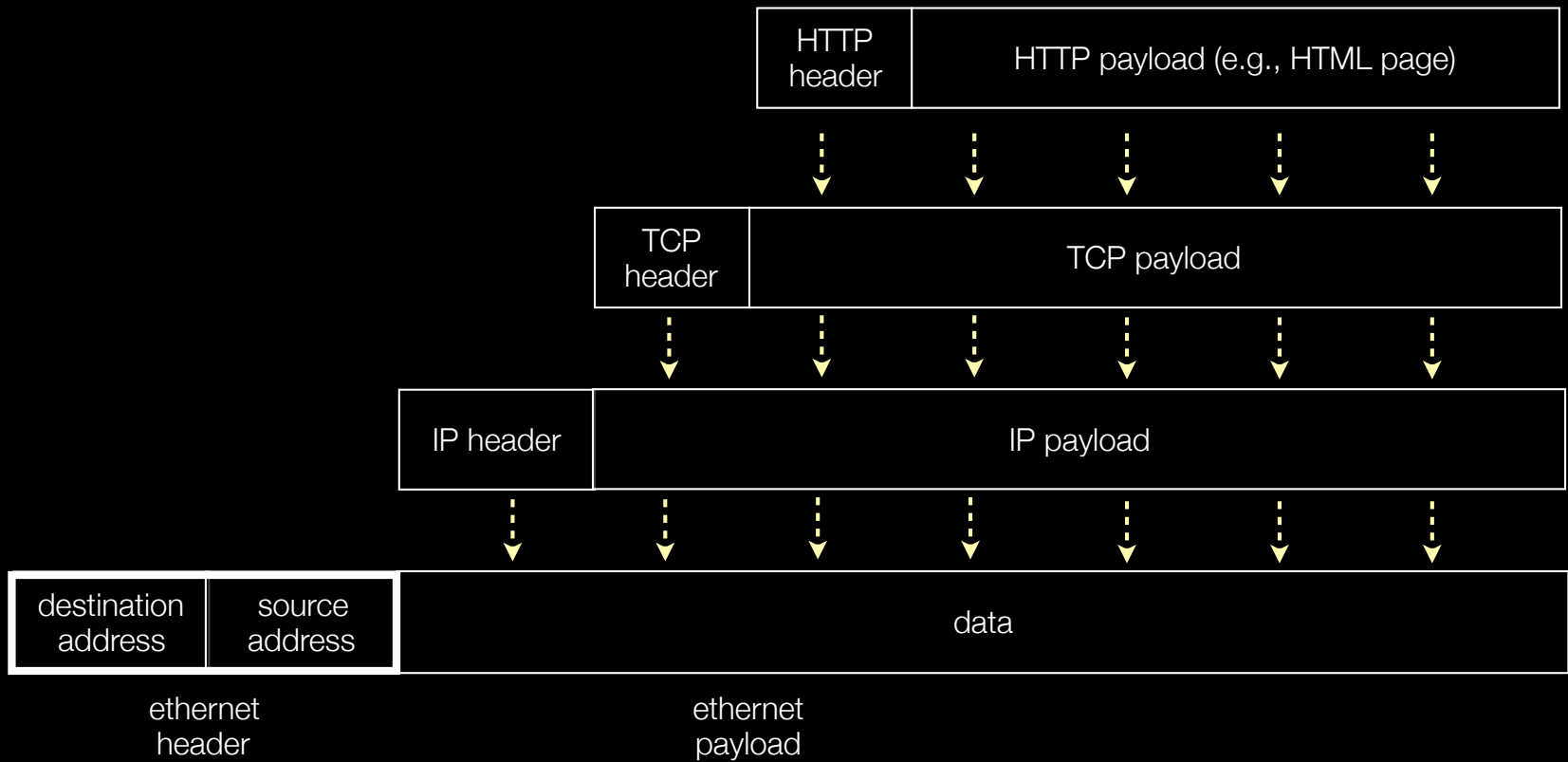

The “application” layer

Packet encapsulation -- same as before!

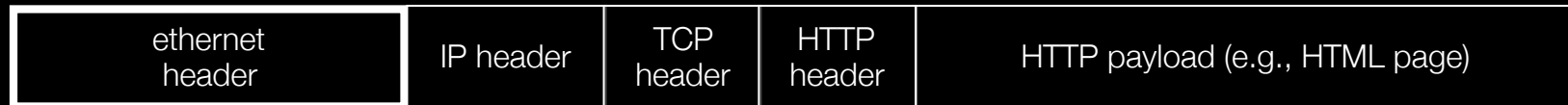

The “application” layer

Popular application-level protocols:

- **DNS**: translates a DNS name (**www.google.com**) into one or more IP addresses (74.125.155.105, 74.125.155.106, ...)
 - ▶ a hierarchy of DNS servers cooperate to do this
- **HTTP**: web protocols
- **SMTP, IMAP, POP**: mail delivery and access protocols
- **ssh**: remote login protocol
- **bittorrent**: peer-to-peer, swarming file sharing protocol

See you on Wednesday!