

Intro to File I/O, System Calls

CSE 333 Winter 2019

Instructor: Hal Perkins

Teaching Assistants:

Alexey Beall

Renshu Gu

Harshita Neti

David Porter

Forrest Timour

Soumya Vasisht

Yifan Xu

Sujie Zhou

Administrivia

- ❖ I/O and System Calls
 - Essential material for next part of the project (hw2)
 - Exercise 6 out today, due Wednesday morning 1/23

- ❖ No class Monday – MLK day
 - Exercise 5 due Wed. instead of Mon.

- ❖ Homework 1 due Thursday (1/24) at 11 pm
 - Submit via *GitLab* (i.e., commit/push changes, then push tag)
 - No exercise due Friday 1/25! Exercise 7 will be released on Thursday, due following Monday

Exercise Grading

- ❖ Problem: how to preserve basic 0,1,2,3 scoring but give more detailed feedback
- ❖ Imperfect solution (that we're using)
 - Overall score is given by a -0, -1, -2, -3 ... item (exceptional=3, fine=2, serious problems=1, hmmm....=0)
 - Specific notes/reasons are additional items with -0 score attached
- ❖ Regrades / questions
 - Probably best to use Gradescope's regrade button, although questions to staff email list are sometimes more appropriate

Lecture Outline

- ❖ **File I/O with the C standard library**
- ❖ System Calls

Remember This Picture?

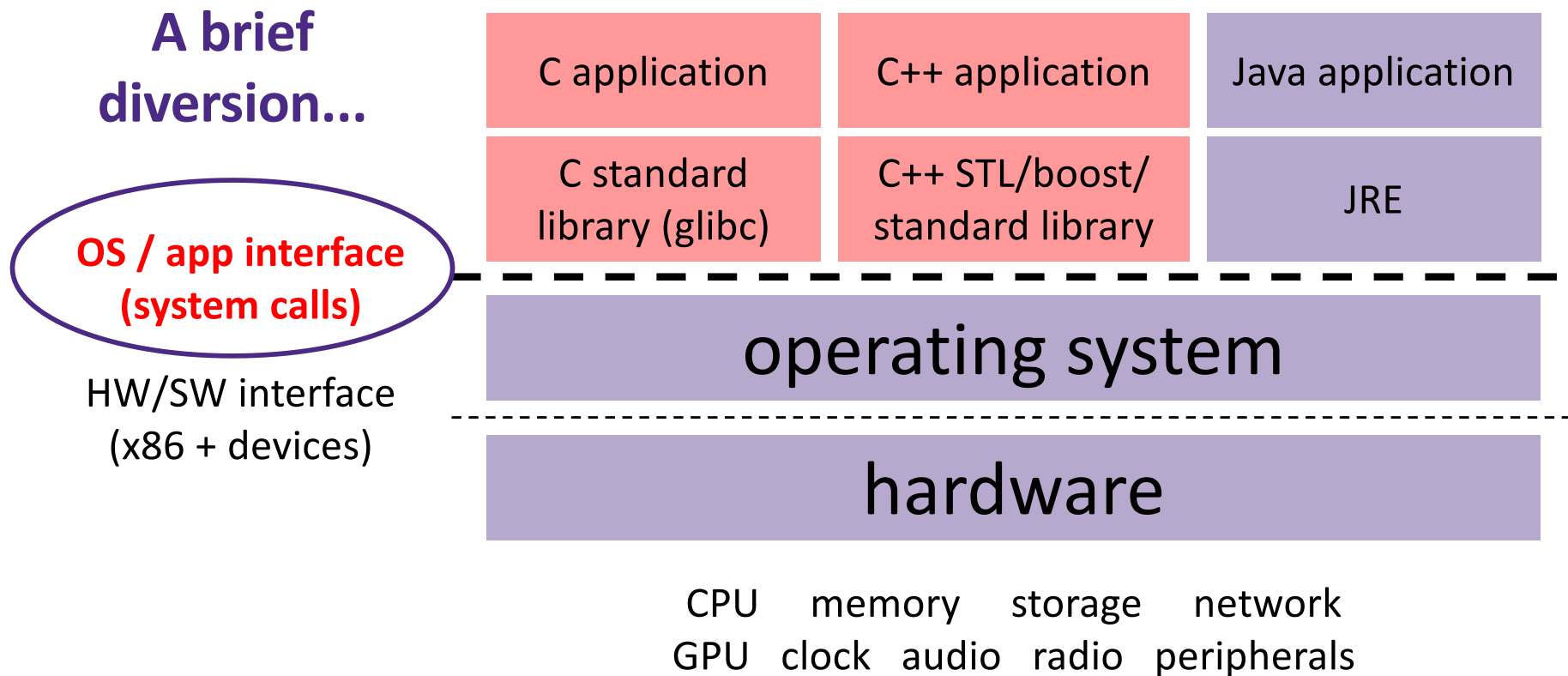

File I/O

- ❖ We'll start by using C's standard library
 - These functions are part of `glibc` on Linux
 - They are implemented using Linux system calls
- ❖ C's `stdio` defines the notion of a **stream**
 - A way of reading or writing a sequence of characters to and from a device
 - Can be either *text* or *binary*; Linux does not distinguish
 - Is *buffered* by default; `libc` reads ahead of your program
 - Three streams provided by default: `stdin`, `stdout`, `stderr`
 - You can open additional streams to read and write to files
 - C streams are manipulated with a `FILE*` pointer, which is defined in `stdio.h`

C Stream Functions

❖ Some stream functions (complete list in `stdio.h`):

■ `FILE* fopen(filename, mode);`

- Opens a stream to the specified file in specified file access mode

■ `int fclose(stream);`

- Closes the specified stream (and file)

■ `int fprintf(stream, format, ...);`

- Writes a formatted C string
 - `printf(...);` is equivalent to `fprintf(stdout, ...);`

■ `int fscanf(stream, format, ...);`

- Reads data and stores data matching the format string

C Stream Functions

❖ Some stream functions (complete list in `stdio.h`):

■ `FILE* fopen(filename, mode);`

- Opens a stream to the specified file in specified file access mode

■ `int fclose(stream);`

- Closes the specified stream (and file)

■ `size_t fwrite(ptr, size, count, stream);`

- Writes an array of *count* elements of *size* bytes from *ptr* to *stream*

■ `size_t fread(ptr, size, count, stream);`

- Reads an array of *count* elements of *size* bytes from *stream* to *ptr*

Error Checking/Handling

❖ Some error functions (complete list in `stdio.h`):

■ `void perror(message);`

- Prints message and error message related to `errno` to `stderr`

■ `int ferror(stream);`

- Checks if the error indicator associated with the specified stream is set

■ `int clearerr(stream);`

- Resets error and eof indicators for the specified stream

C Streams Example

cp_example.c

```
#include <stdio.h>
#include <stdlib.h>
#include <errno.h>
#define READBUFSIZE 128

int main(int argc, char** argv) {
    FILE *fin, *fout;
    char readbuf[READBUFSIZE];
    size_t readlen;

    if (argc != 3) {
        fprintf(stderr, "usage: ./cp_example infile outfile\n");
        return EXIT_FAILURE;        // defined in stdlib.h
    }

    // Open the input file
    fin = fopen(argv[1], "rb"); // "rb" -> read, binary mode
    if (fin == NULL) {
        fprintf(stderr, "%s -- ", argv[1]);
        perror("fopen for read failed");
        return EXIT_FAILURE;
    }
    ...
}
```

C Streams Example

cp_example.c

```
int main(int argc, char** argv) {  
  
    ...    // previous slide's code  
  
    // Open the output file  
    fout = fopen(argv[2], "wb"); // "wb" -> write, binary mode  
    if (fout == NULL) {  
        fprintf(stderr, "%s -- ", argv[2]);  
        perror("fopen for write failed");  
        return EXIT_FAILURE;  
    }  
  
    // Read from the file, write to fout  
    while ((readlen = fread(readbuf, 1, READBUFSIZE, fin)) > 0) {  
        if (fwrite(readbuf, 1, readlen, fout) < readlen) {  
            perror("fwrite failed");  
            return EXIT_FAILURE;  
        }  
    }  
  
    ...    // next slide's code  
  
}
```

C Streams Example

cp_example.c

```
int main(int argc, char** argv) {  
  
    ...    // Slide 7's code  
  
    ...    // Slide 8's code  
  
    // Test to see if we encountered an error while reading  
    if (ferror(fin)) {  
        perror("fread failed");  
        return EXIT_FAILURE;  
    }  
  
    fclose(fin);  
    fclose(fout);  
  
    return EXIT_SUCCESS;  
}
```

Buffering

- ❖ By default, `stdio` uses **buffering** for streams:
 - Data written by **`fwrite()`** is copied into a buffer allocated by `stdio` inside your process' address space
 - As some point, the buffer will be “drained” into the destination:
 - When you explicitly call **`fflush()`** on the stream
 - When the buffer size is exceeded (often 1024 or 4096 bytes)
 - For `stdout` to console, when a newline is written (“*line buffered*”) or when some other function tries to read from the console
 - When you call **`fclose()`** on the stream
 - When your process exits gracefully (**`exit()`** or `return` from **`main()`**)

Buffering Issues

- ❖ What happens if...
 - Your computer loses power before the buffer is flushed?
 - Your program assumes data is written to a file and signals another program to read it?

- ❖ Performance implications:
 - Data is *copied* into the stdio buffer
 - Consumes CPU cycles and memory bandwidth
 - Can potentially slow down high-performance applications, like a web server or database (“*zero-copy*”)

Buffering Issue Solutions

- ❖ Turn off buffering with `setbuf (stream, NULL)`
 - Unfortunately, this may also cause performance problems
 - e.g. if your program does many small `fwrite ()`s, each one will now trigger a system call into the Linux kernel
- ❖ Use a different set of system calls
 - POSIX (OS layer) provides `open ()`, `read ()`, `write ()`, `close ()`, etc.
 - No buffering is done at the user level
- ❖ But... what about the layers below?
 - The OS caches disk reads and writes in the FS *buffer* cache
 - Disk controllers have caches too!

Lecture Outline

- ❖ File I/O with the C standard library
- ❖ **System Calls**

What's an OS?

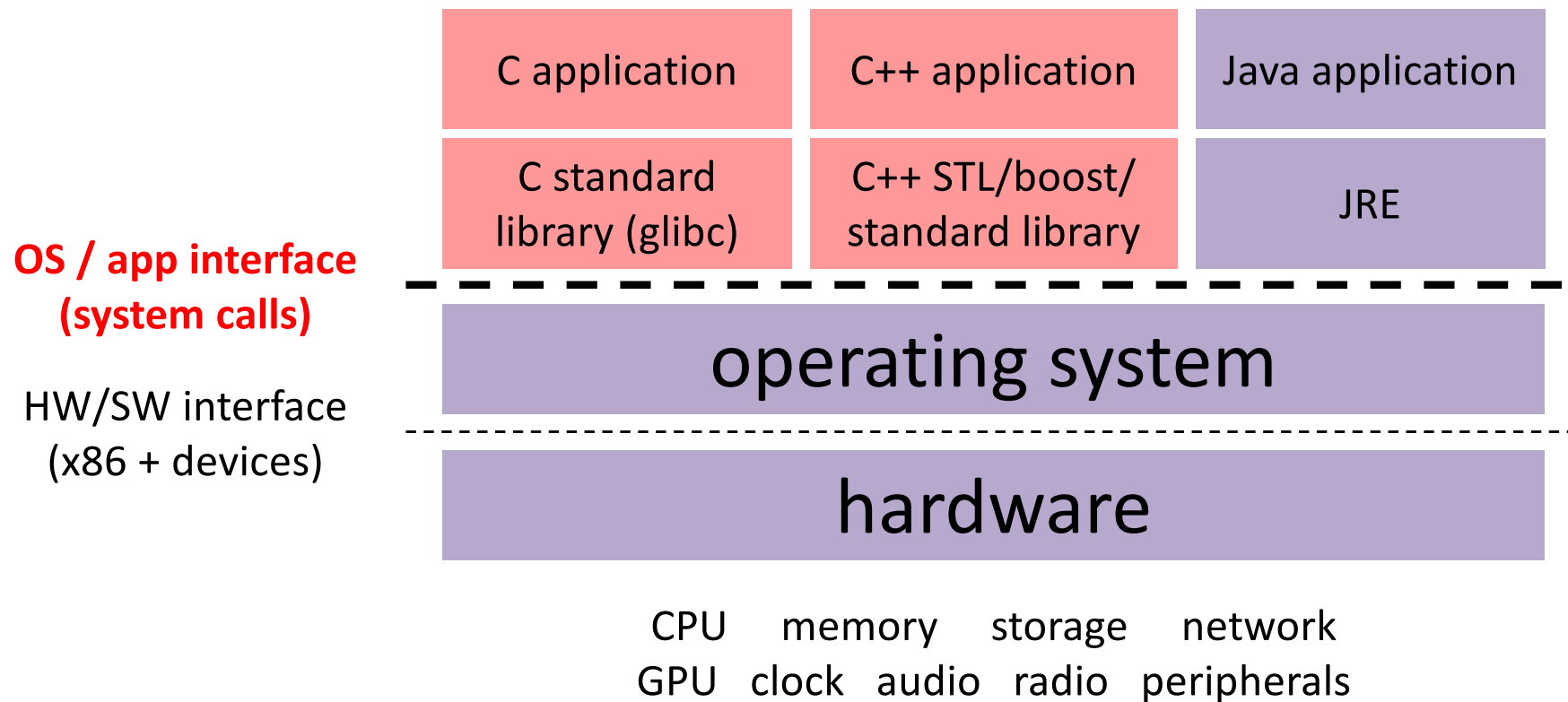

What's an OS?

❖ Software that:

- Directly interacts with the hardware
 - OS is trusted to do so; user-level programs are not
 - OS must be ported to new hardware; user-level programs are portable
- Manages (allocates, schedules, protects) hardware resources
 - Decides which programs can access which files, memory locations, pixels on the screen, etc. and when
- Abstracts away messy hardware devices
 - Provides high-level, convenient, portable abstractions (*e.g.* files, disk blocks)

OS: Abstraction Provider

- ❖ The OS is the “layer below”
 - A module that your program can call (with **system calls**)
 - Provides a powerful OS API – POSIX, Windows, etc.

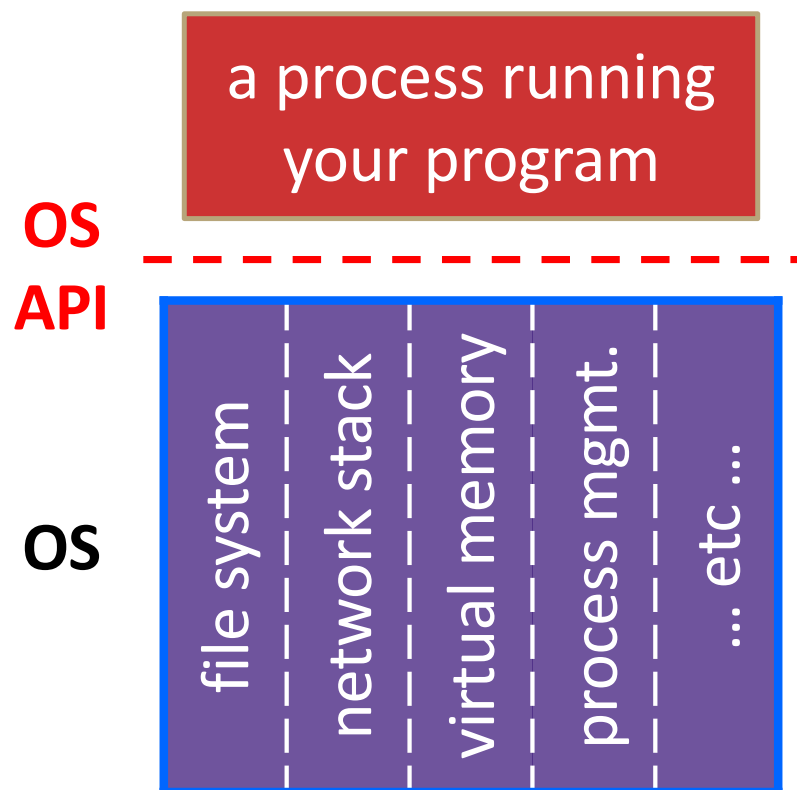

File System

- `open()`, `read()`, `write()`, `close()`, ...

Network Stack

- `connect()`, `listen()`, `read()`, `write()`, ...

Virtual Memory

- `brk()`, `shm_open()`, ...

Process Management

- `fork()`, `wait()`, `nice()`, ...

OS: Protection System

- ❖ OS isolates process from each other
 - But permits controlled sharing between them
 - Through shared name spaces (*e.g.* file names)
- ❖ OS isolates itself from processes
 - Must prevent processes from accessing the hardware directly
- ❖ OS is allowed to access the hardware
 - User-level processes run with the CPU (processor) in **unprivileged mode**
 - The OS runs with the CPU in **privileged mode**
 - User-level processes invoke system calls to safely enter the OS

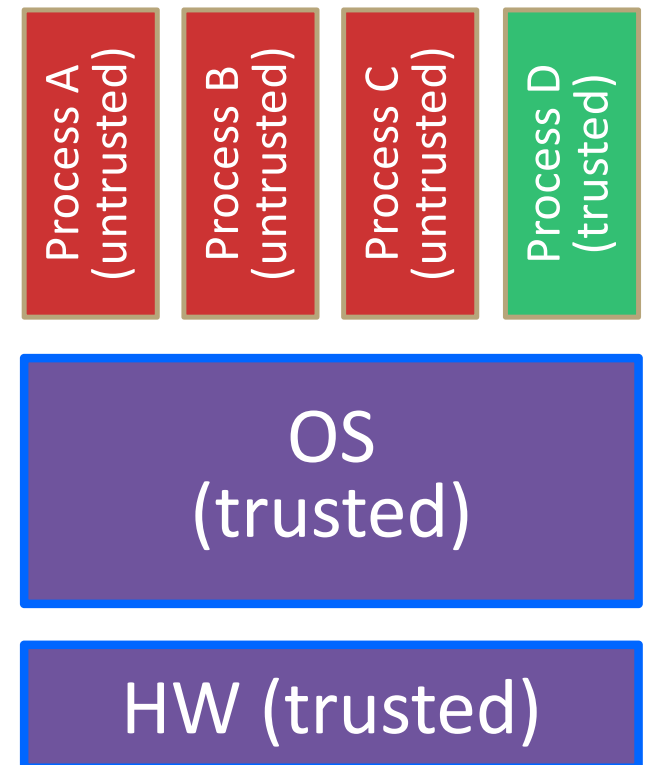

System Call Trace

A CPU (thread of execution) is running user-level code in Process A; the CPU is set to *unprivileged mode*.

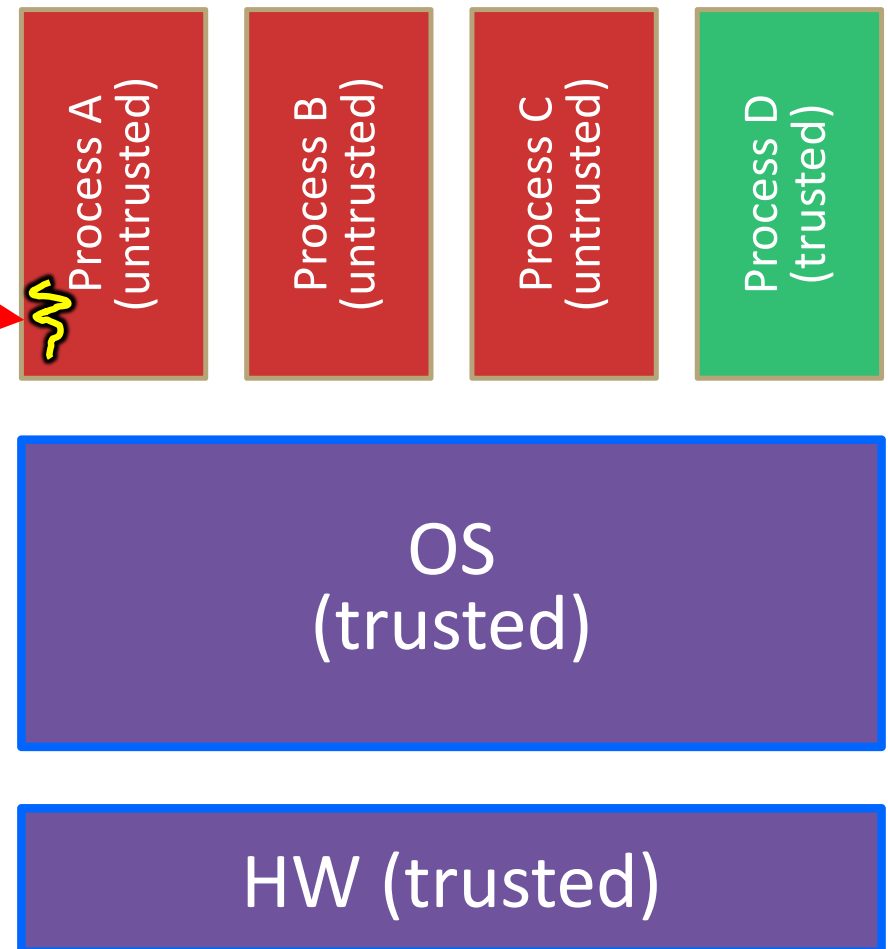

System Call Trace

Code in Process A invokes a system call; the hardware then sets the CPU to *privileged mode* and traps into the OS, which invokes the appropriate system call handler.

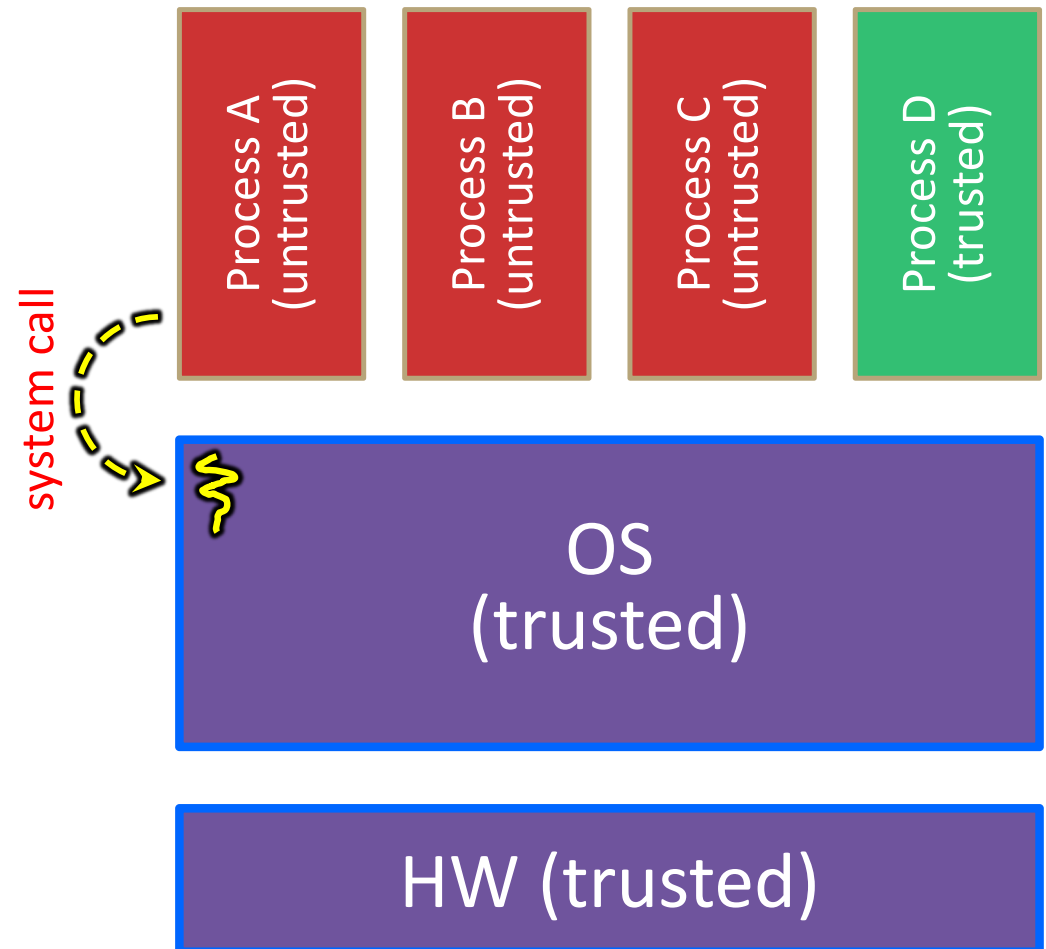

System Call Trace

Because the CPU executing the thread that's in the OS is in privileged mode, it is able to use *privileged instructions* that interact directly with hardware devices like disks.

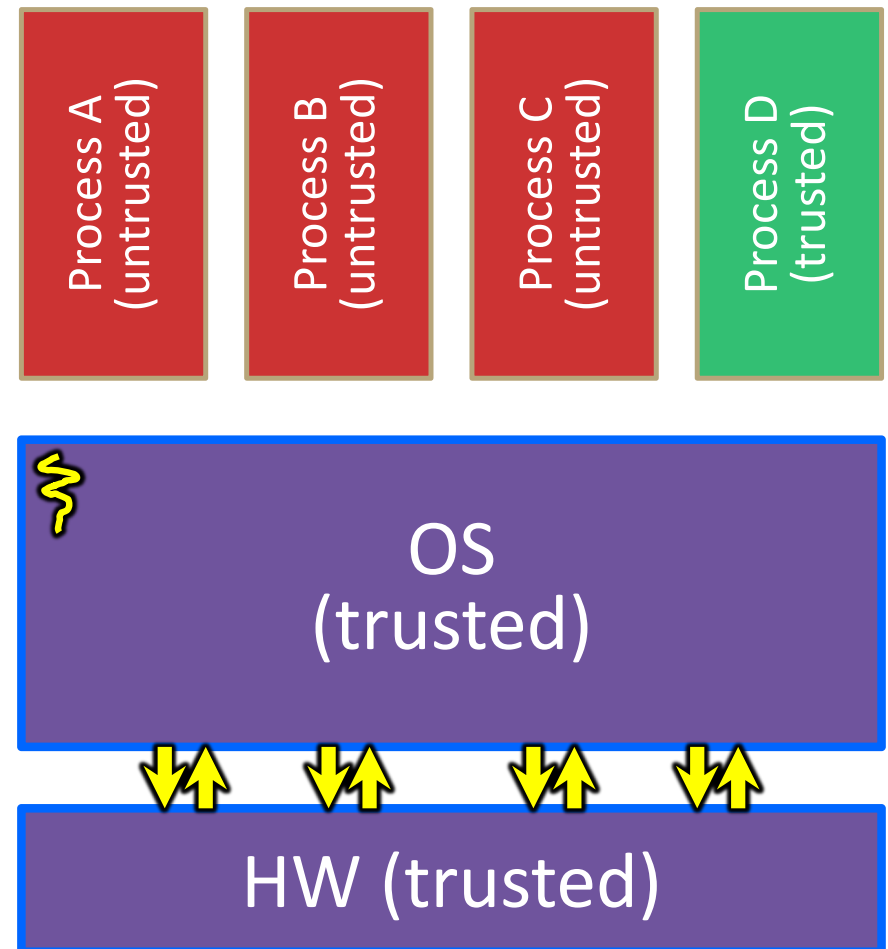

System Call Trace

Once the OS has finished servicing the system call, which might involve long waits as it interacts with HW, it:

- (1) Sets the CPU back to unprivileged mode and
- (2) Returns out of the system call back to the user-level code in Process A.

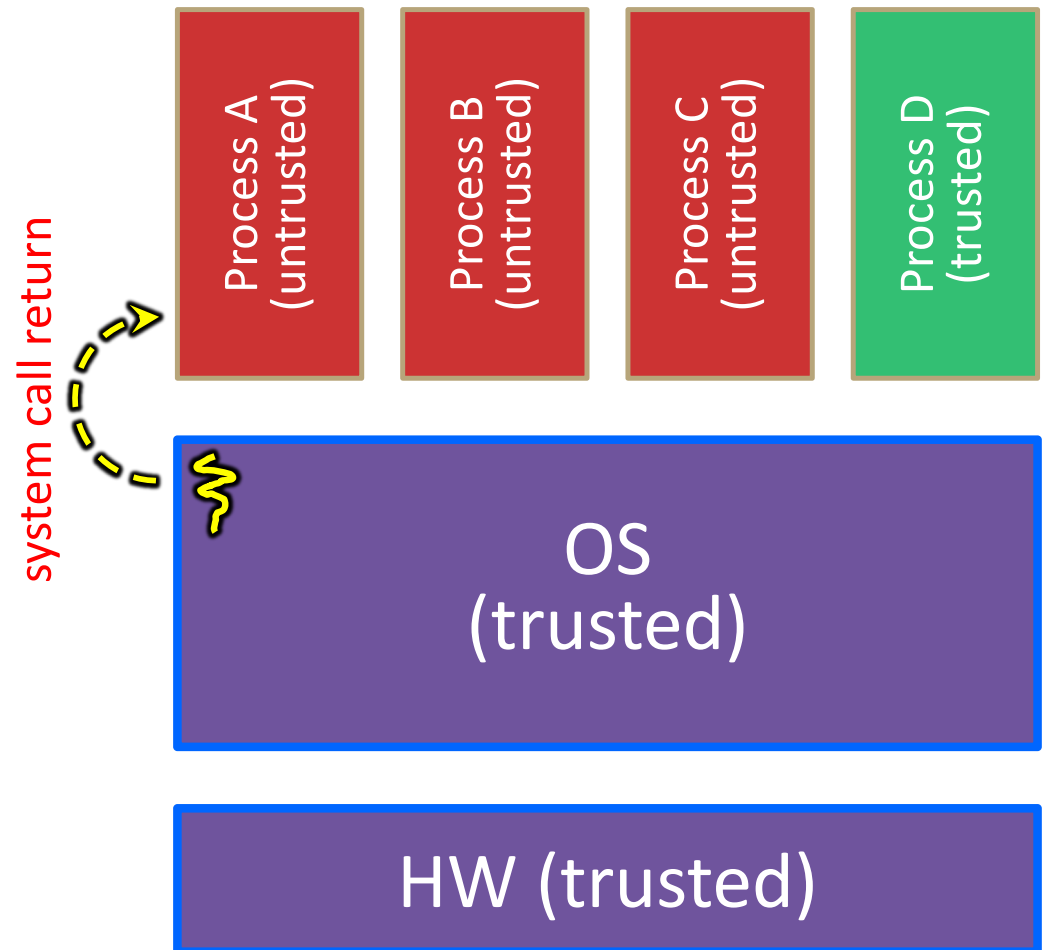

System Call Trace

The process continues executing whatever code is next after the system call invocation.

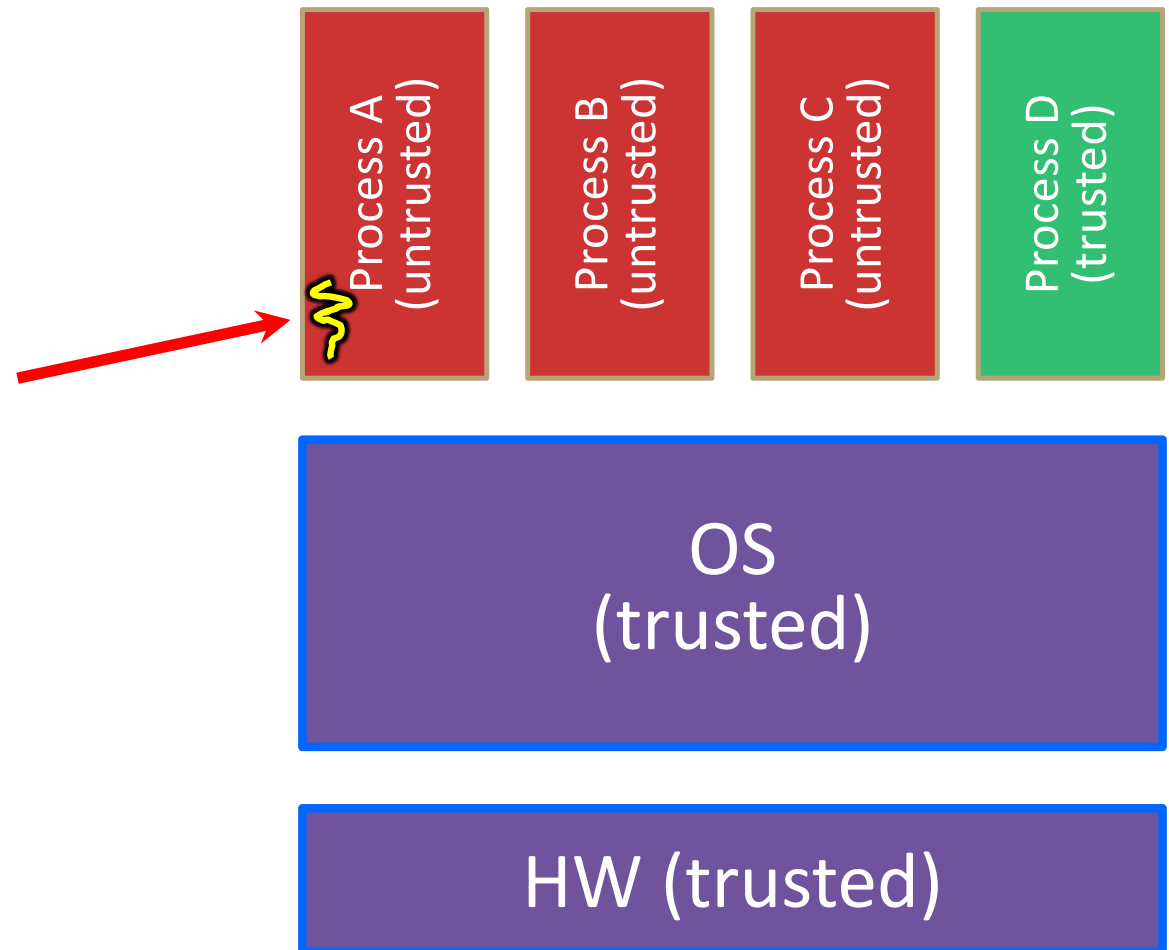

Useful reference:
CSPP § 8.1–8.3
(the 351 book)

Details on x86/Linux

- ❖ A more accurate picture:
 - Consider a typical Linux process
 - Its thread of execution can be in one of several places:
 - In your program's code
 - In `glibc`, a shared library containing the C standard library, POSIX, support, and more
 - In the Linux architecture-independent code
 - In Linux x86-64 code

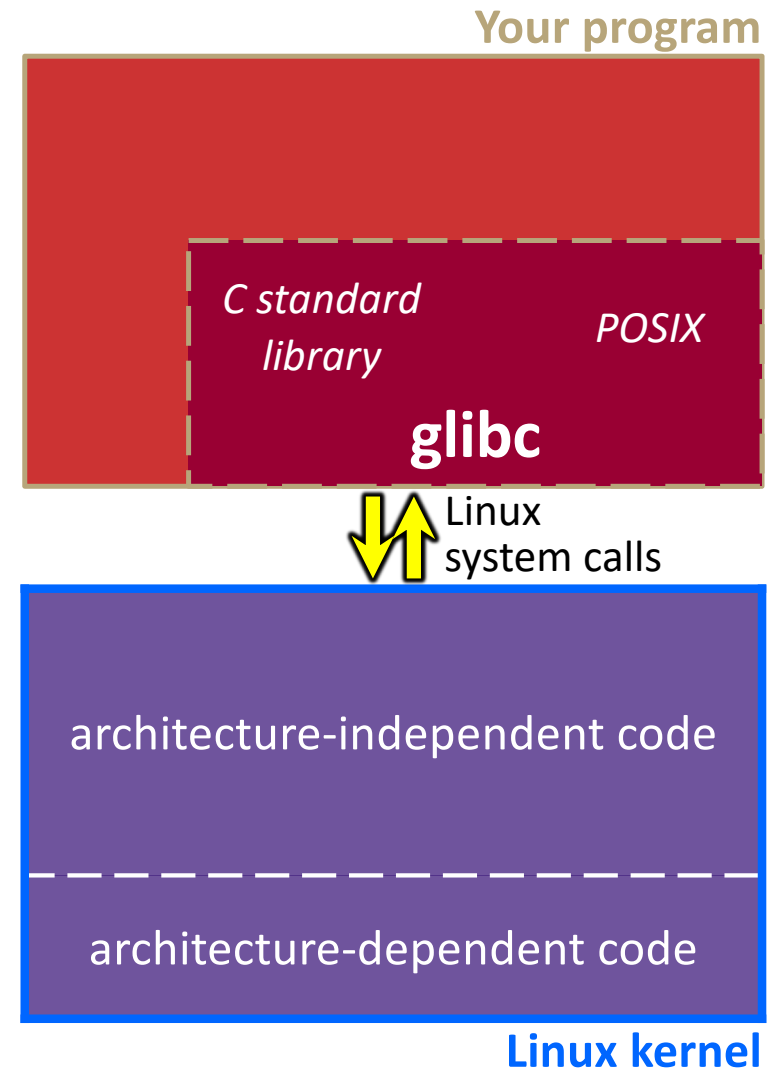

Details on x86/Linux

- ❖ Some routines your program invokes may be entirely handled by `glibc` without involving the kernel
 - *e.g.* `strcmp()` from `stdio.h`
 - There is some initial overhead when invoking functions in dynamically linked libraries (during loading)
 - But after symbols are resolved, invoking `glibc` routines is basically as fast as a function call within your program itself!

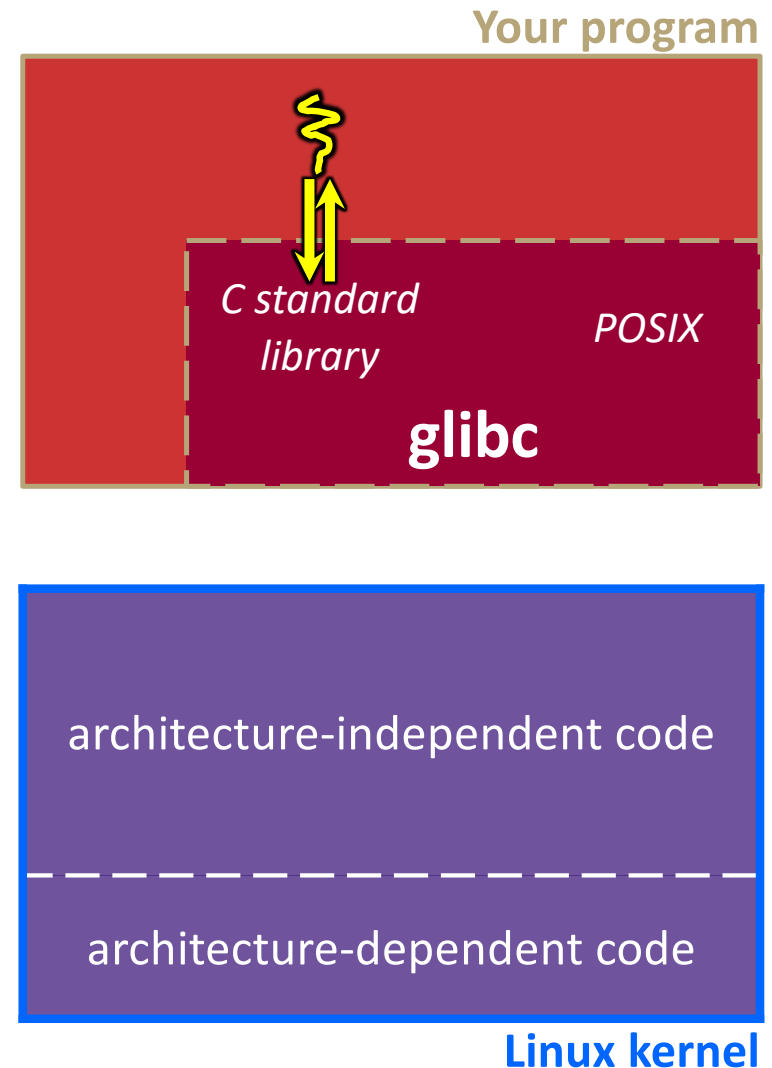

Details on x86/Linux

- ❖ Some routines may be handled by `glibc`, but they in turn invoke Linux system calls
 - *e.g.* POSIX wrappers around Linux `syscalls`
 - POSIX `readdir()` invokes the underlying Linux `readdir()`
 - *e.g.* C `stdio` functions that read and write from files
 - `fopen()`, `fclose()`, `fprintf()` invoke underlying Linux `open()`, `close()`, `write()`, etc.

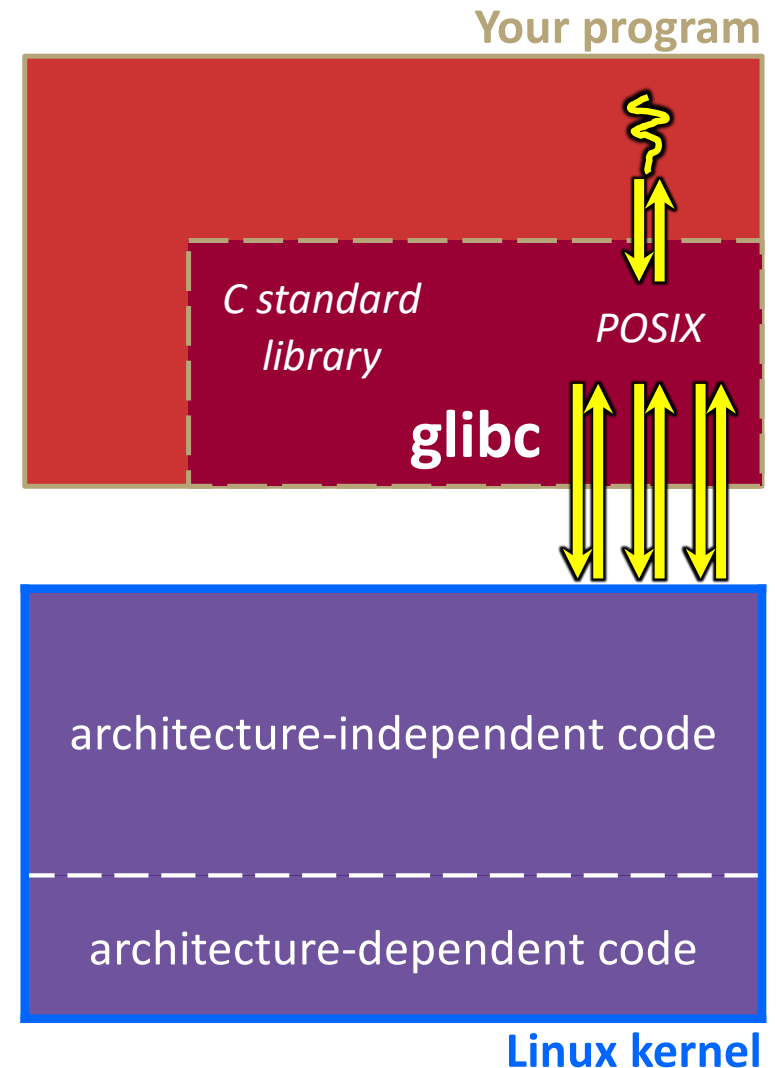

Details on x86/Linux

- ❖ Your program can choose to directly invoke Linux system calls as well
 - Nothing is forcing you to link with `glibc` and use it
 - But relying on directly-invoked Linux system calls may make your program less portable across UNIX varieties

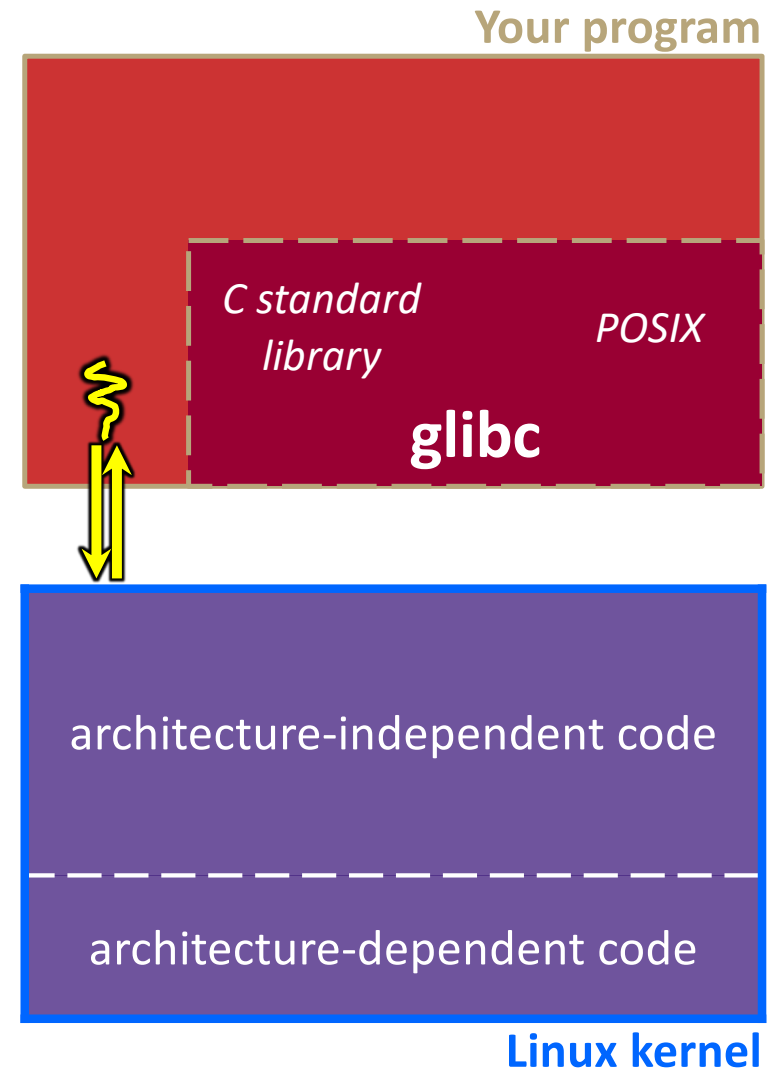

Details on x86/Linux

- ❖ Let's walk through how a Linux system call actually works
 - We'll assume *32-bit x86* using the modern `SYSENTER / SYSEXIT` x86 instructions
 - x86-64 code is similar, though details always change over time, so take this as an example – not a debugging guide

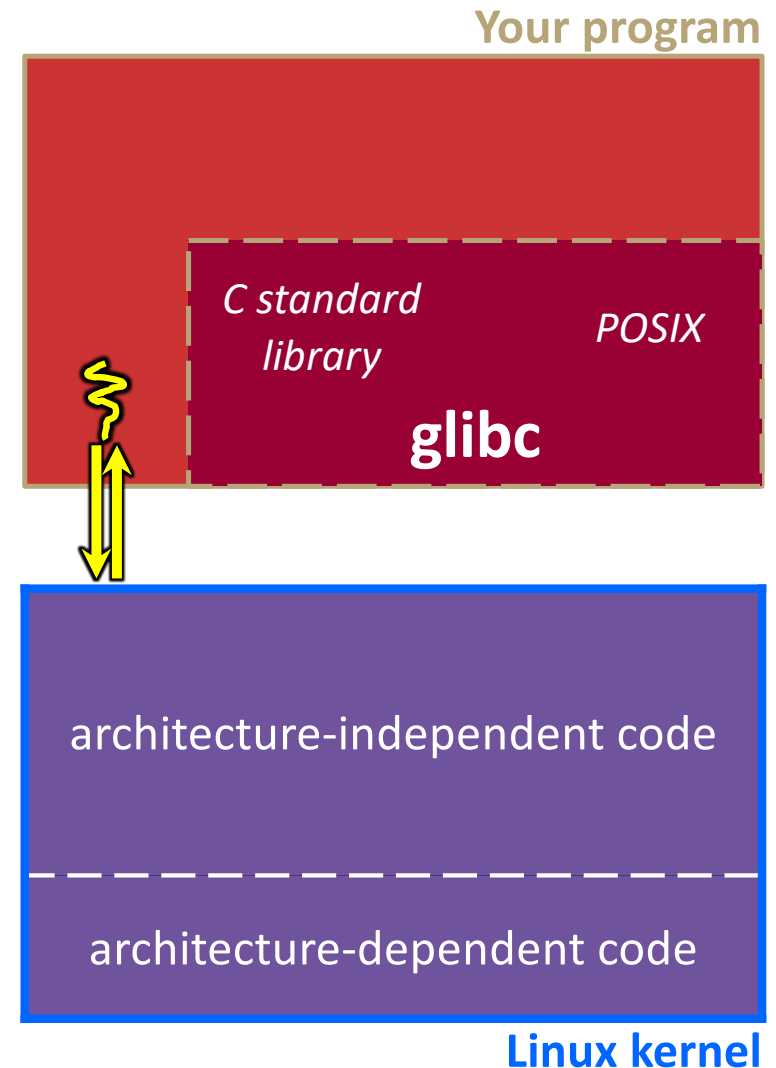

Details on x86/Linux

Remember our process address space picture?

- Let's add some details:

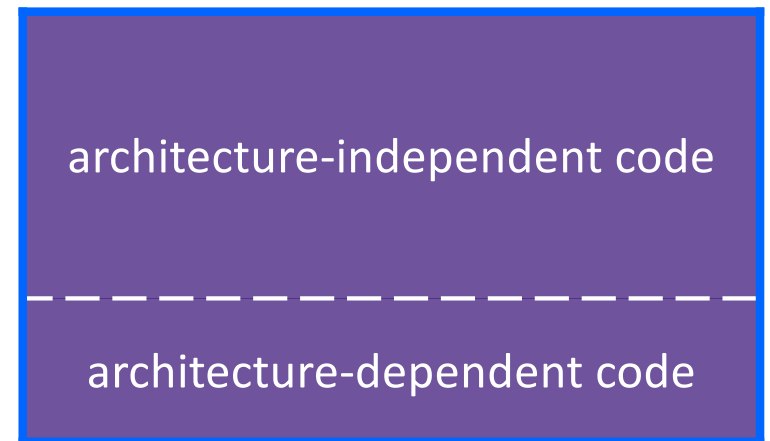
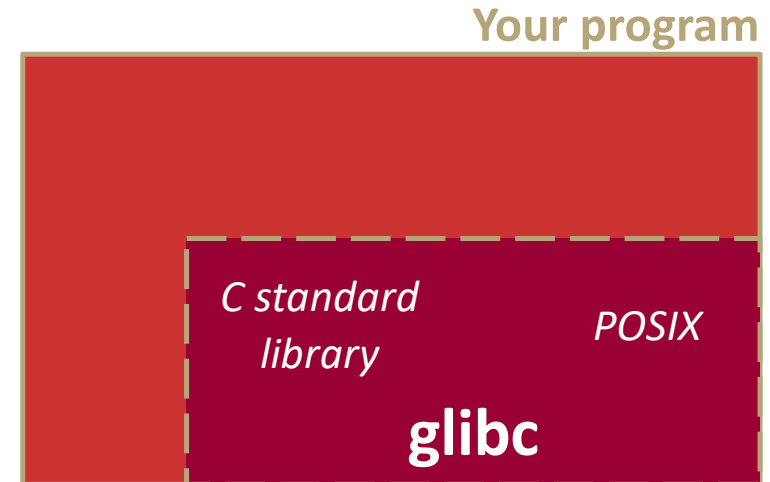
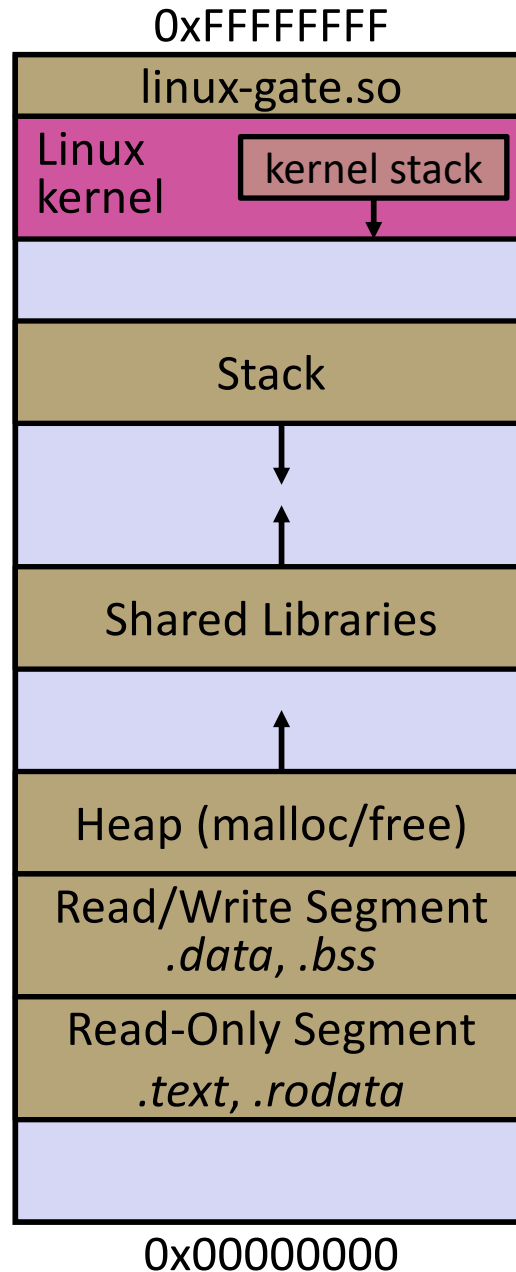

Linux kernel



Details on x86/Linux

Process is executing your program code

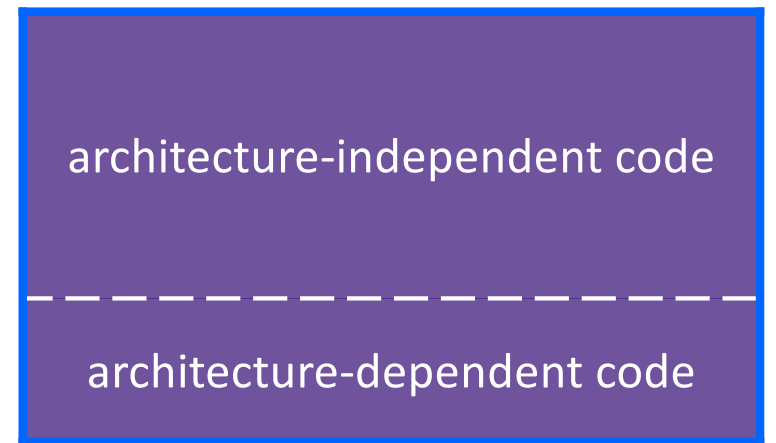
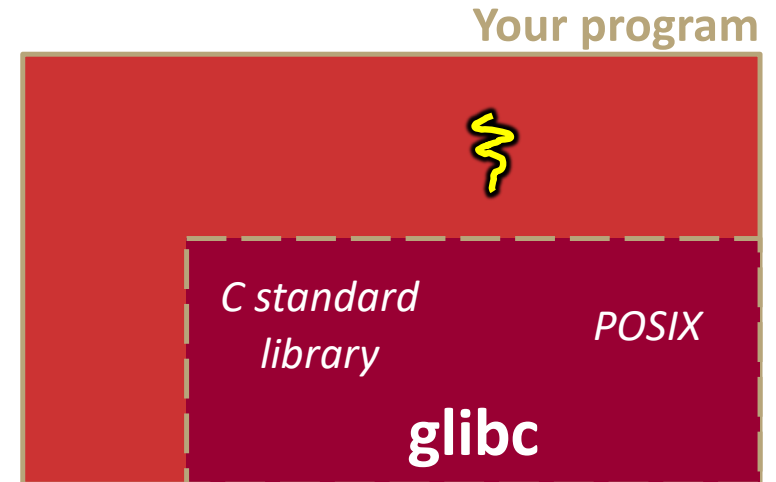
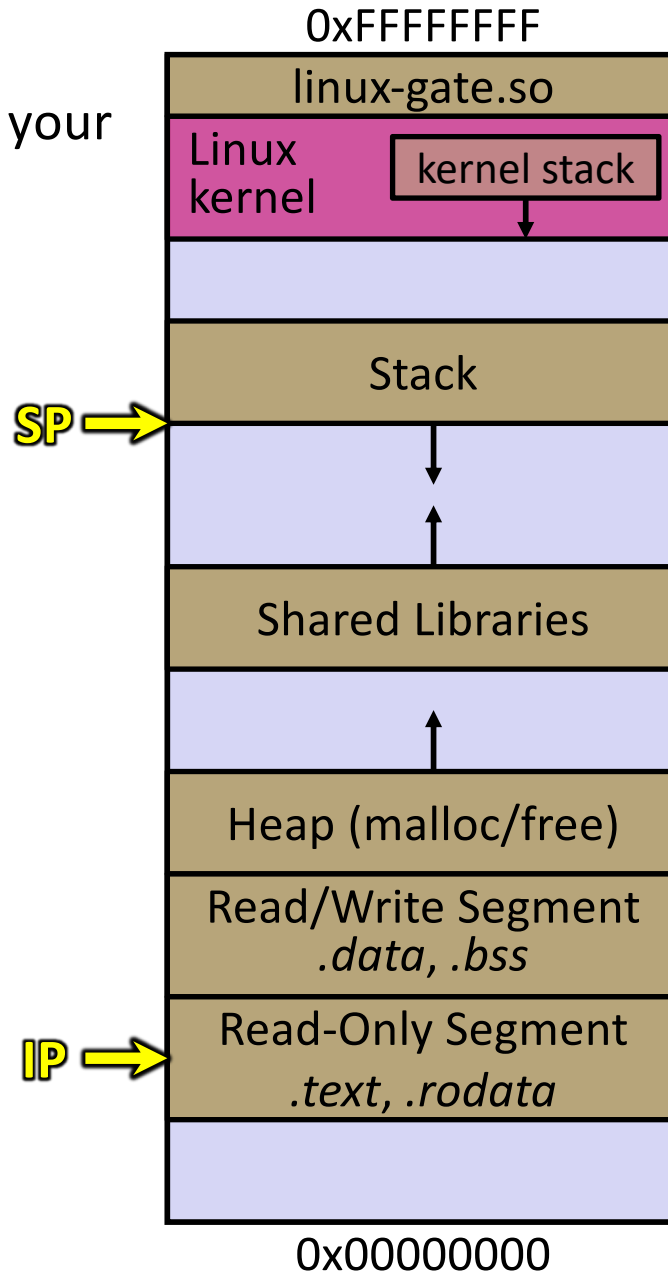

Details on x86/Linux

Process calls into a `glibc` function

- *e.g.* `fopen()`
- We'll ignore the messy details of loading/linking shared libraries

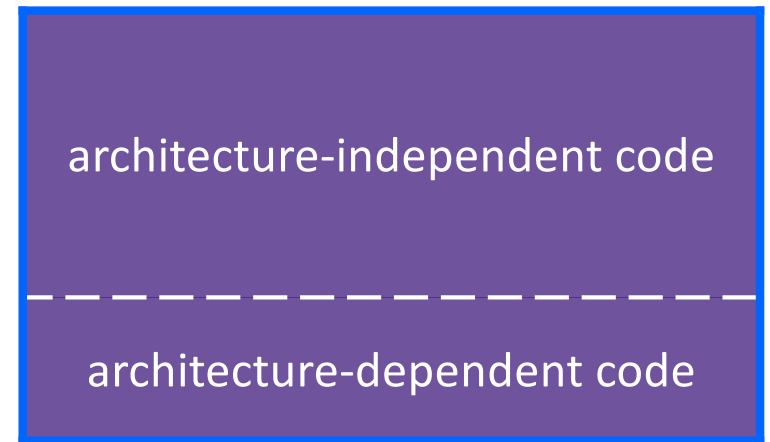
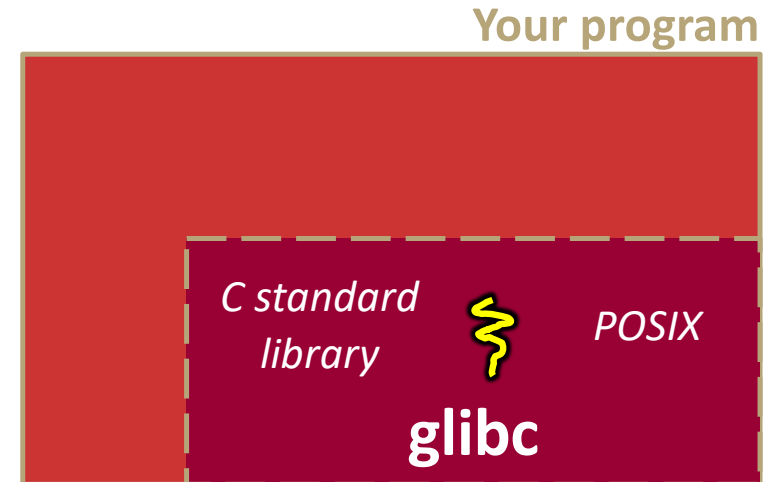
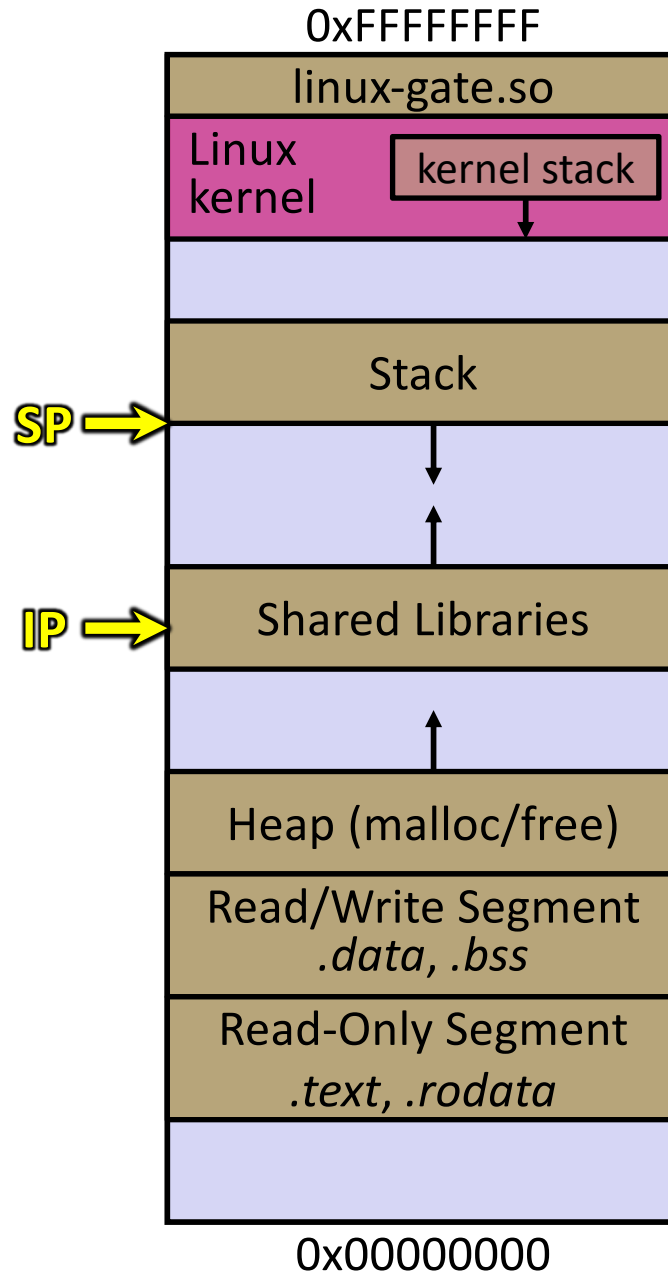

Linux kernel



Details on x86/Linux

`glibc` begins the process of invoking a Linux system call

- `glibc`'s `fopen()` likely invokes Linux's `open()` system call
- Puts the system call # and arguments into registers
- Uses the `call` x86 instruction to call into the routine `__kernel_vsyscall` located in `linux-gate.so`

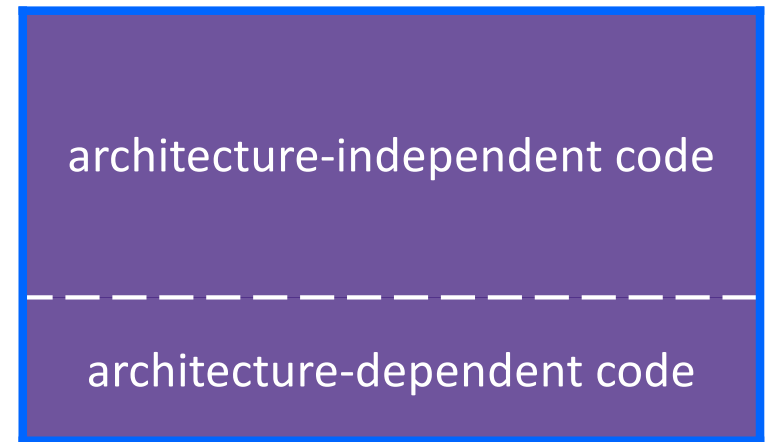
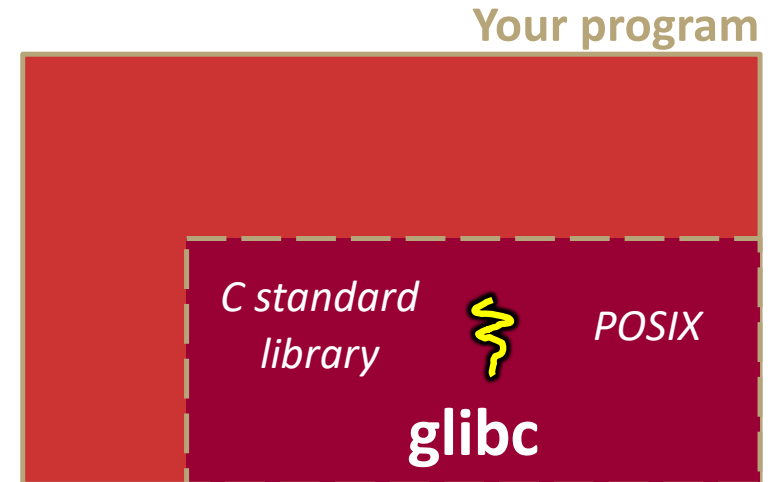
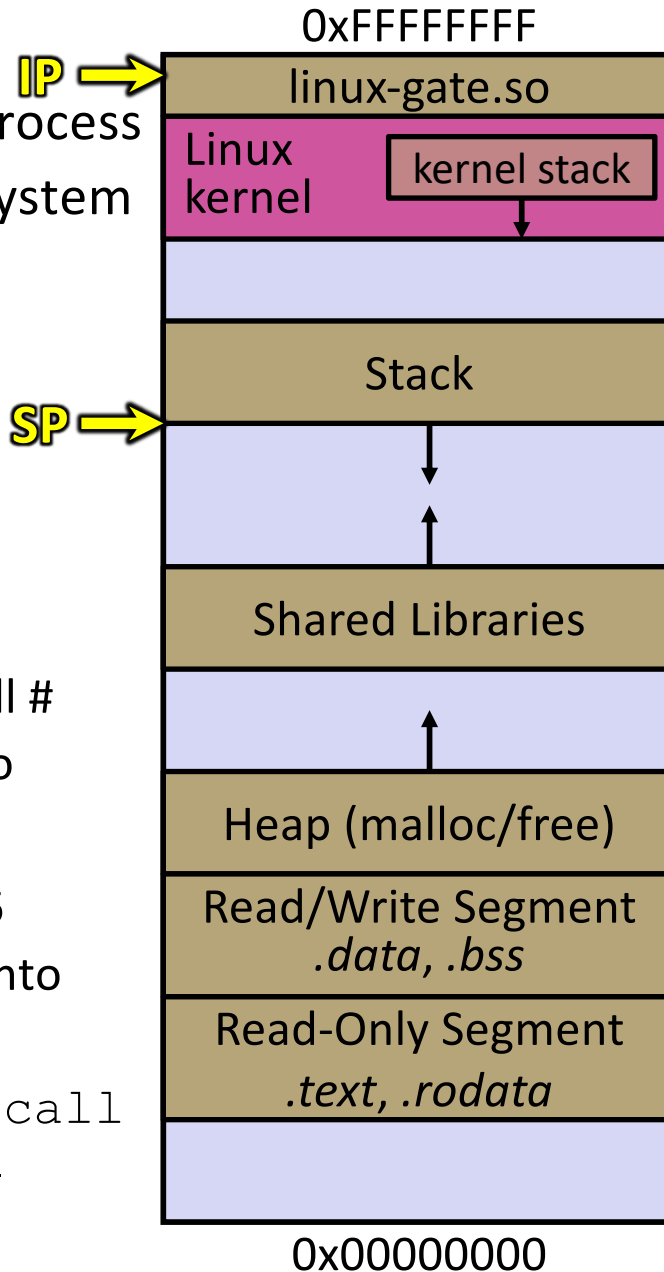

Linux kernel



Details on x86/Linux

linux-gate.so is a **vdso**

- A virtual dynamically-linked shared object
- Is a kernel-provided shared library that is plunked into a process' address space
- Provides the intricate machine code needed to trigger a system call

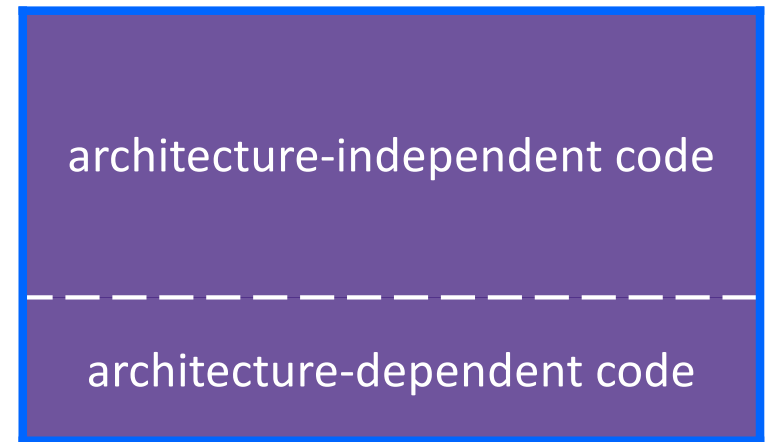
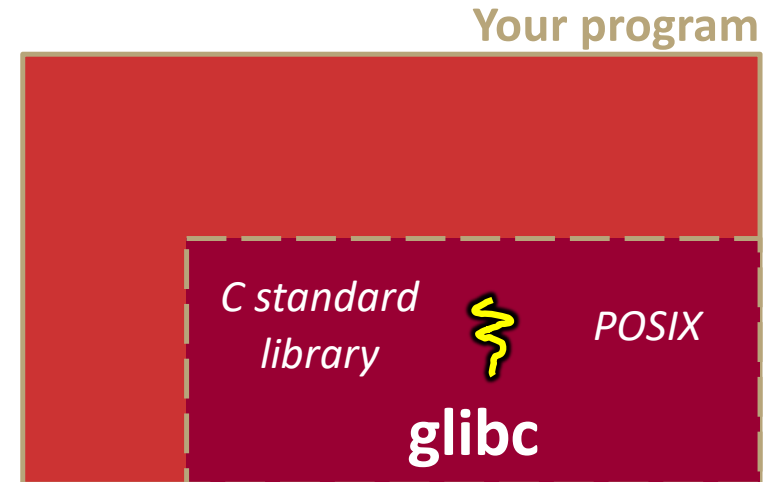
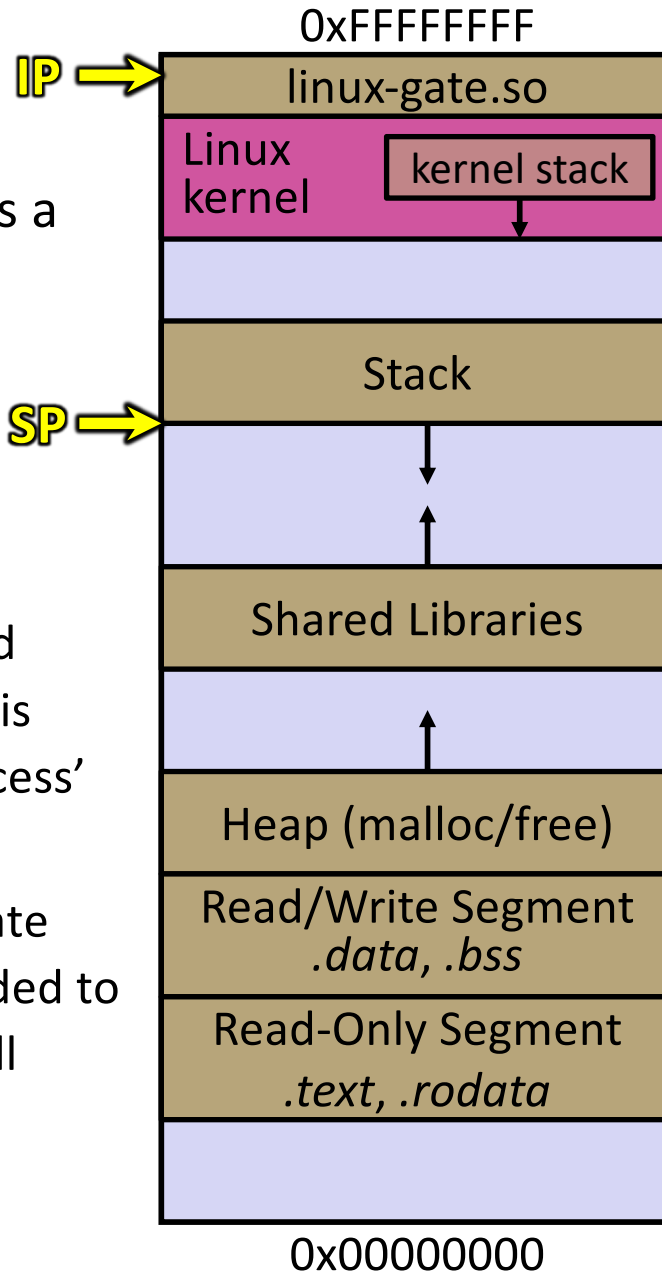

Details on x86/Linux

linux-gate.so eventually invokes the SYSENTER x86 instruction

- SYSENTER is x86's "fast system call" instruction
 - Causes the CPU to raise its privilege level
 - Traps into the Linux kernel by changing the SP, IP to a previously-determined location
 - Changes some segmentation-related registers (see CSE451)

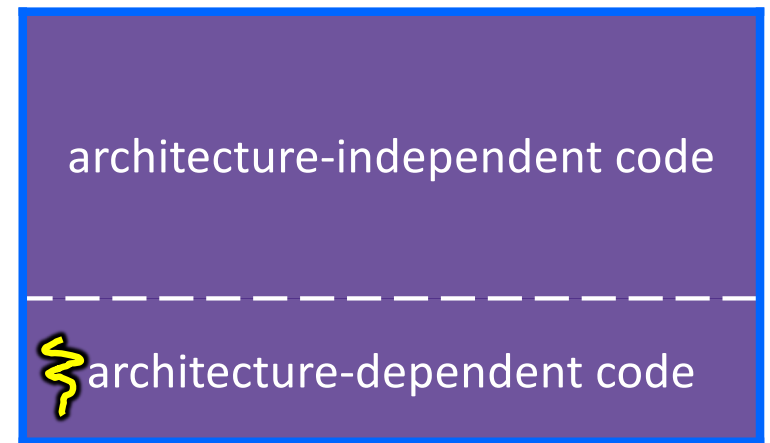
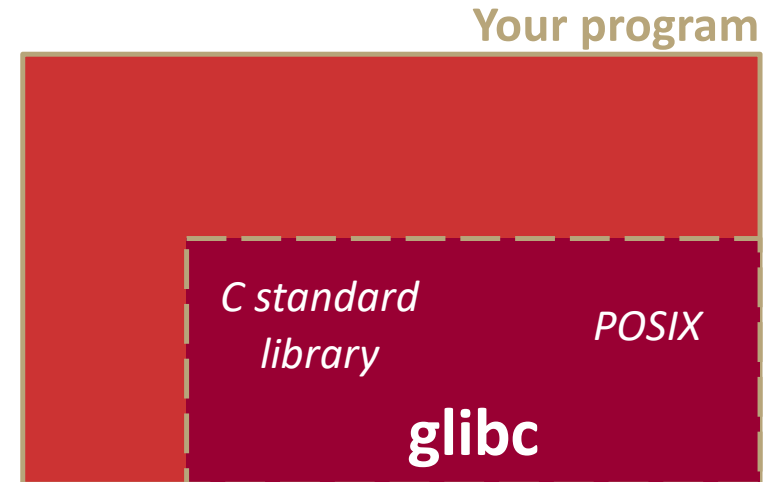
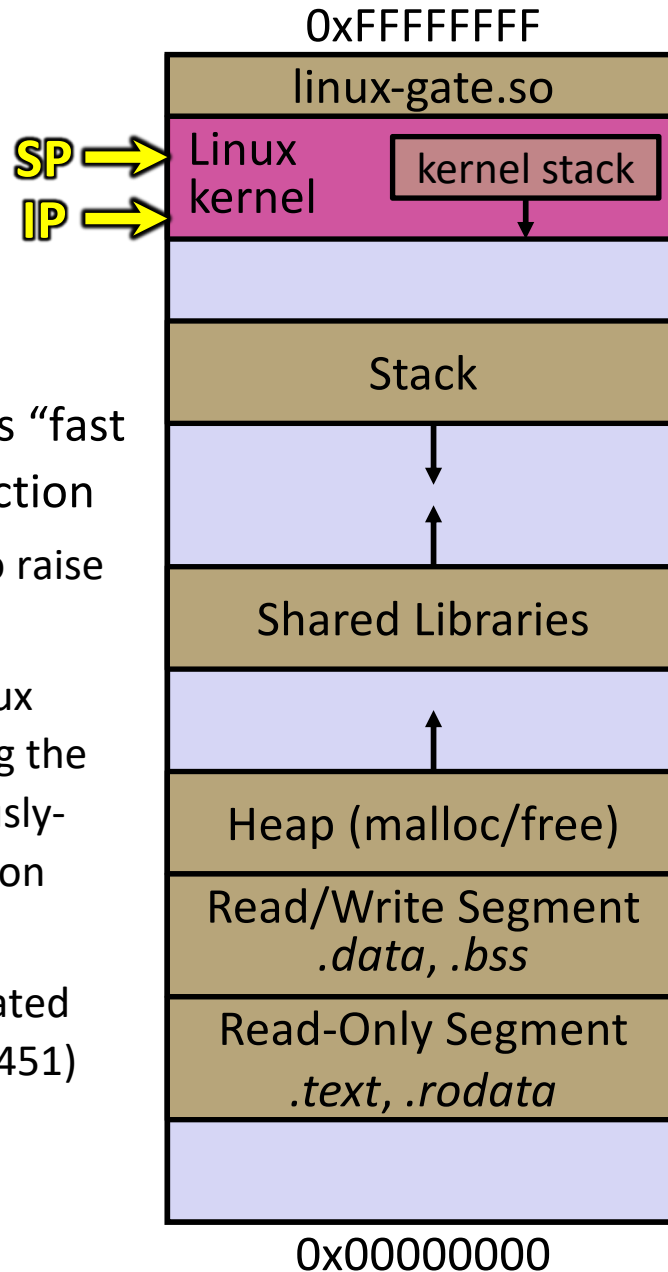

Details on x86/Linux

The kernel begins executing code at the `SYSENTER` entry point

- Is in the architecture-dependent part of Linux
- It's job is to:
 - Look up the system call number in a system call dispatch table
 - Call into the address stored in that table entry; this is Linux's system call handler
 - For `open()`, the handler is named `sys_open`, and is system call #5

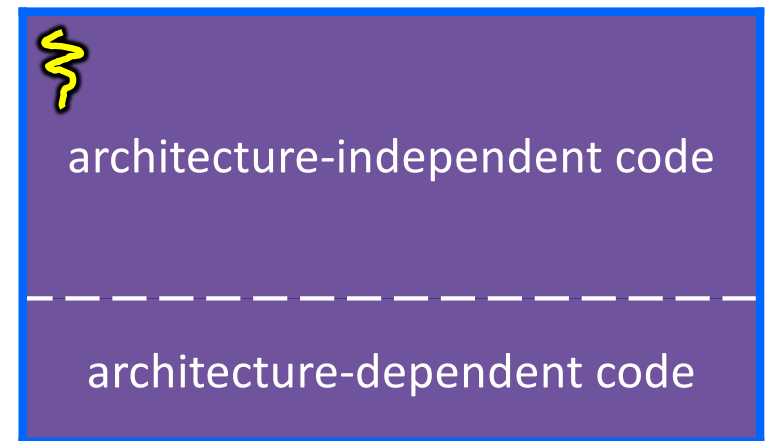
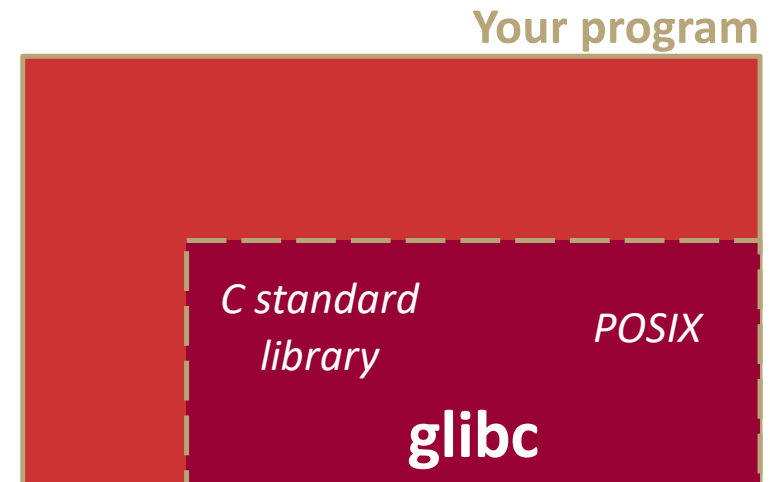
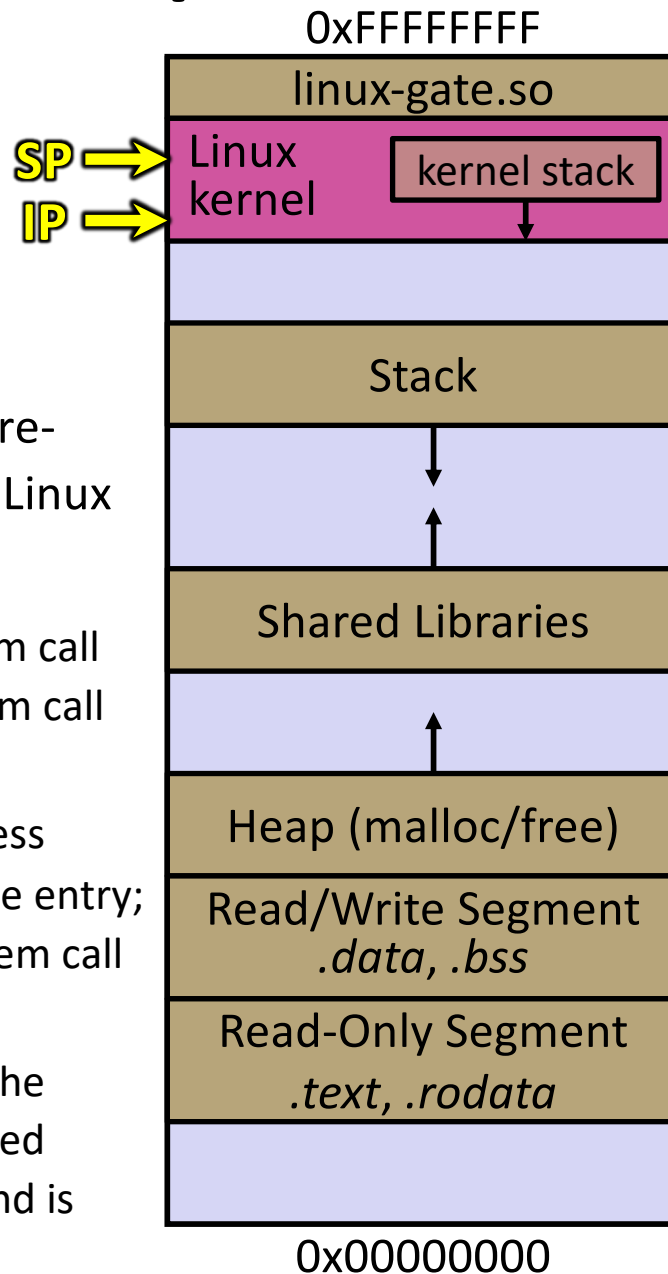

Linux kernel



Details on x86/Linux

The system call handler executes

- What it does is system-call specific
- It may take a long time to execute, especially if it has to interact with hardware
 - Linux may choose to context switch the CPU to a different runnable process

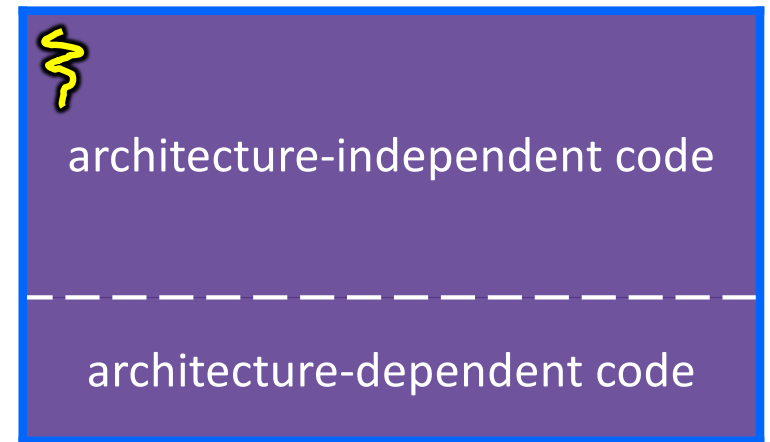
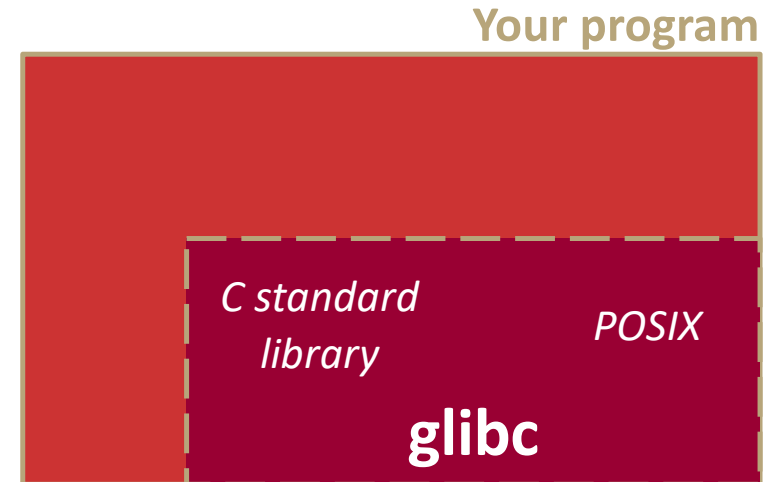
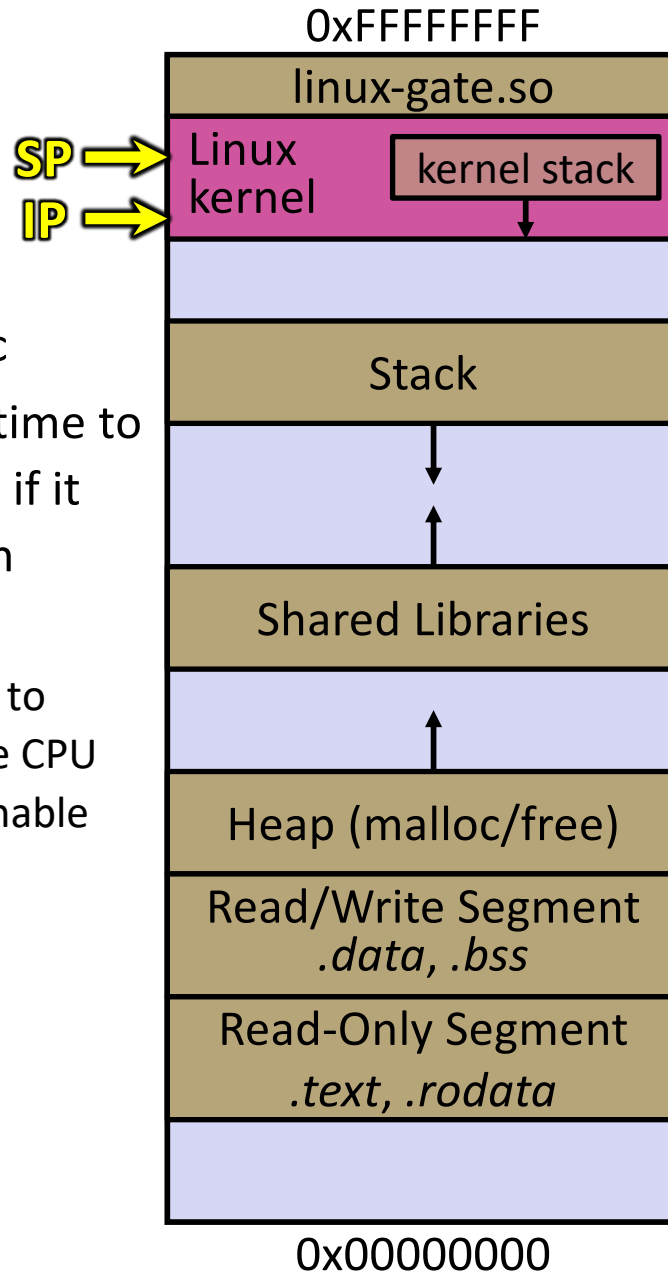

Linux kernel



Details on x86/Linux

Eventually, the system call handler finishes

- Returns back to the system call entry point
 - Places the system call's return value in the appropriate register
 - Calls `SYSEXIT` to return to the user-level code

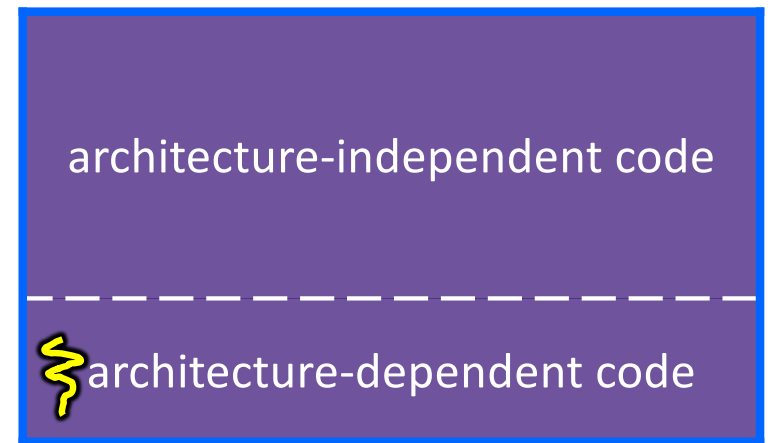
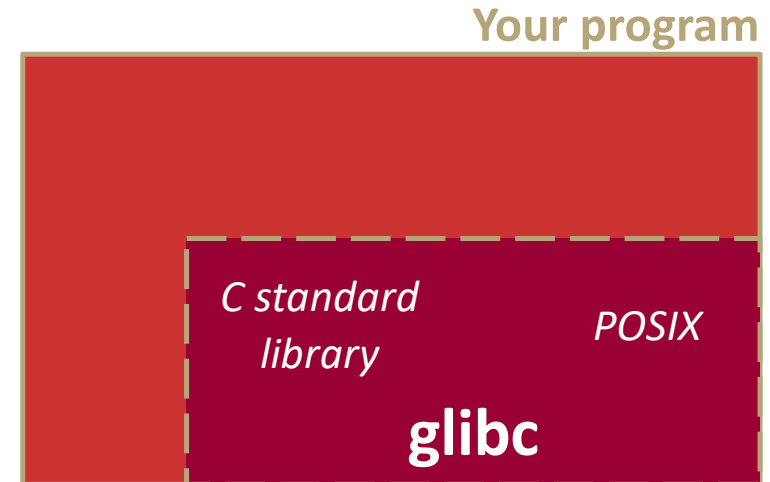
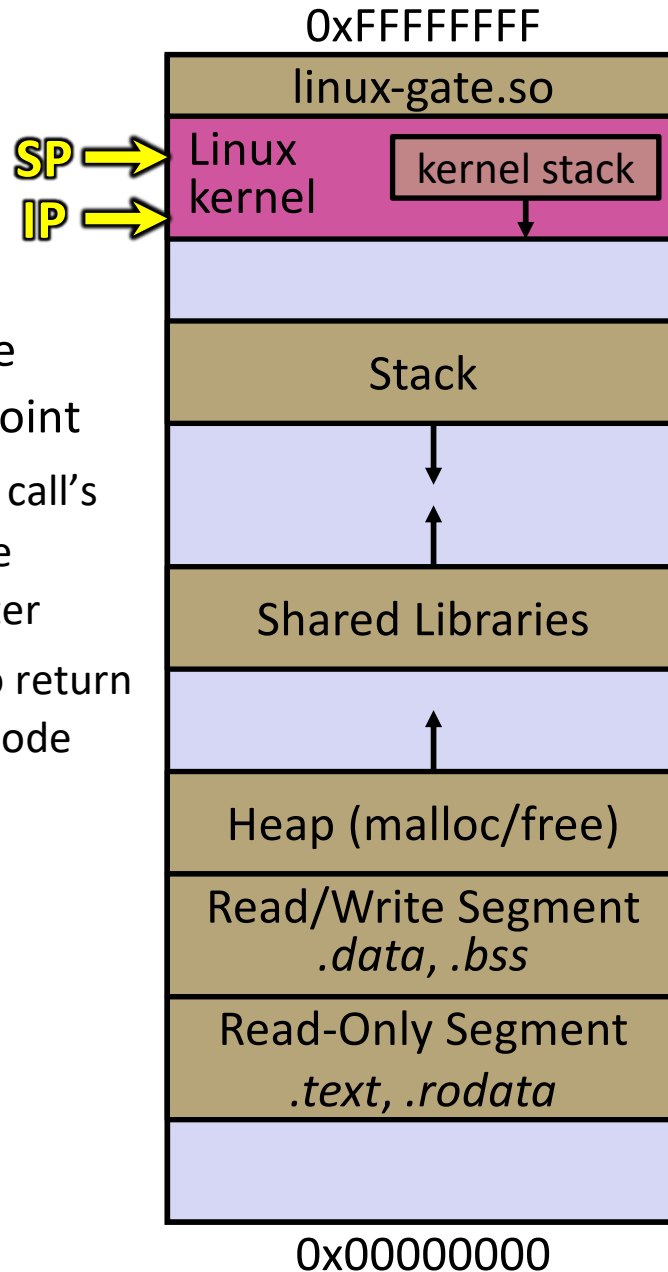

Details on x86/Linux

SYSEXIT transitions the processor back to user-mode code

- Restores the IP, SP to user-land values
- Sets the CPU back to unprivileged mode
- Changes some segmentation-related registers (see CSE451)
- Returns the processor back to `glibc`

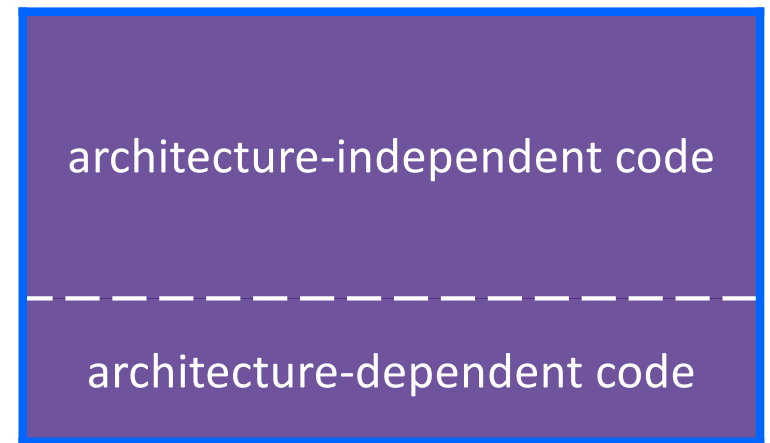
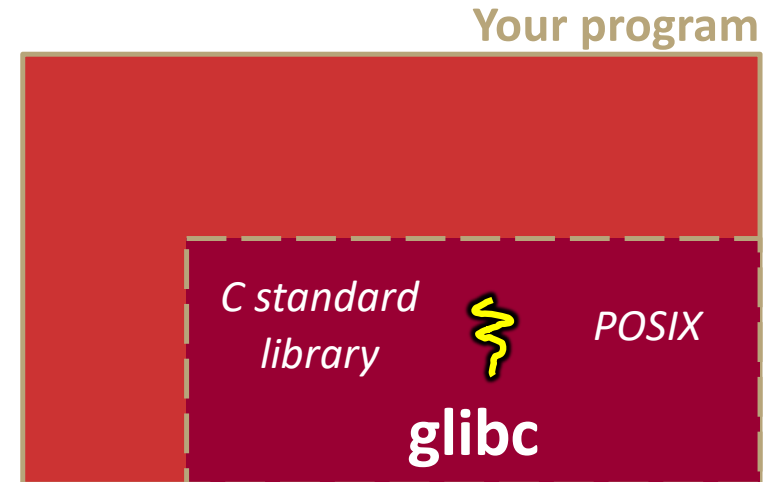
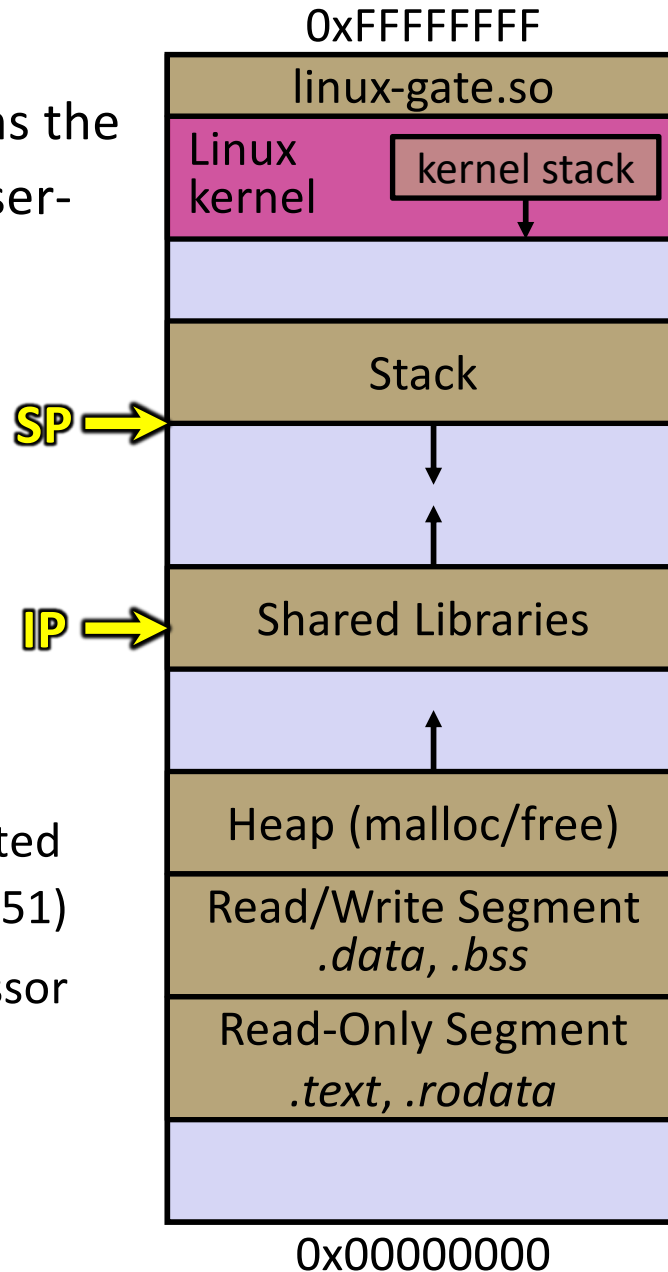

Linux kernel



Details on x86/Linux

glibc continues to execute

- Might execute more system calls
- Eventually returns back to your program code

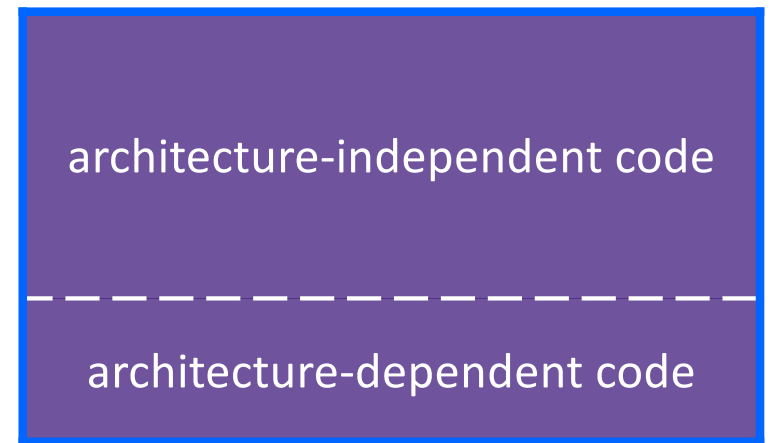
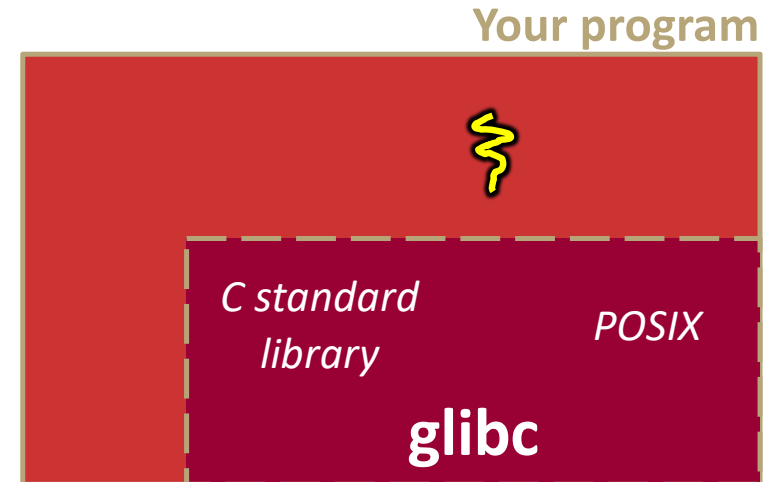
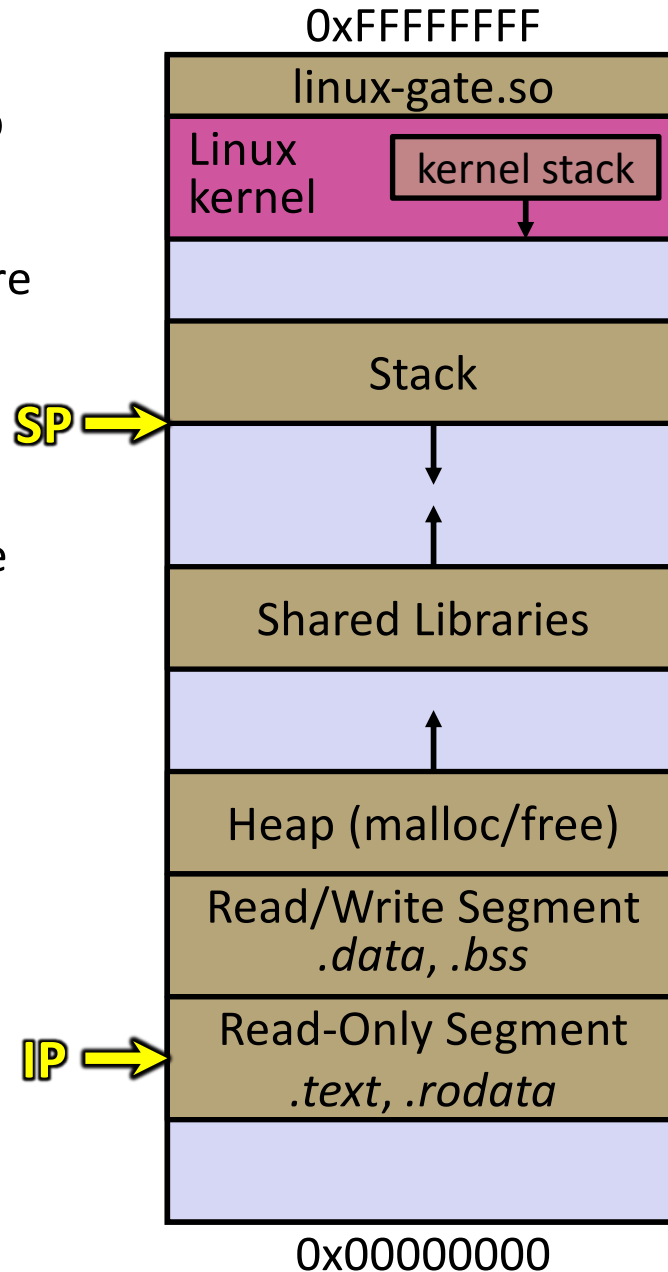

Linux kernel



strace

- ❖ A useful Linux utility that shows the sequence of system calls that a process makes:

```
bash$ strace ls 2>&1 | less
execve("/usr/bin/ls", ["ls"], [/* 41 vars */]) = 0
brk(NULL) = 0x15aa000
mmap(NULL, 4096, PROT_READ|PROT_WRITE, MAP_PRIVATE|MAP_ANONYMOUS, -1, 0) =
    0x7f03bb741000
access("/etc/ld.so.preload", R_OK) = -1 ENOENT (No such file or directory)
open("/etc/ld.so.cache", O_RDONLY|O_CLOEXEC) = 3
fstat(3, {st_mode=S_IFREG|0644, st_size=126570, ...}) = 0
mmap(NULL, 126570, PROT_READ, MAP_PRIVATE, 3, 0) = 0x7f03bb722000
close(3) = 0
open("/lib64/libselinux.so.1", O_RDONLY|O_CLOEXEC) = 3
read(3, "\177ELF\2\1\1\0\0\0\0\0\0\0\0\3\0>\0\1\0\0\0\300j\0\0\0\0\0"...
    832) = 832
fstat(3, {st_mode=S_IFREG|0755, st_size=155744, ...}) = 0
mmap(NULL, 2255216, PROT_READ|PROT_EXEC, MAP_PRIVATE|MAP_DENYWRITE, 3, 0) =
    0x7f03bb2fa000
mprotect(0x7f03bb31e000, 2093056, PROT_NONE) = 0
mmap(0x7f03bb51d000, 8192, PROT_READ|PROT_WRITE,
    MAP_PRIVATE|MAP_FIXED|MAP_DENYWRITE, 3, 0x23000) = 0x7f03bb51d000
... etc ...
```

If You're Curious

- ❖ Download the Linux kernel source code
 - Available from <http://www.kernel.org/>
- ❖ man, section 2: Linux system calls
 - `man 2 intro`
 - `man 2 syscalls`
- ❖ man, section 3: `glibc/libc` library functions
 - `man 3 intro`
- ❖ *The book: [The Linux Programming Interface](#) by Michael Kerrisk (keeper of the Linux man pages)*

Extra Exercise #1

- ❖ Write a program that:
 - Uses `argc/argv` to receive the name of a text file
 - Reads the contents of the file a line at a time
 - Parses each line, converting text into a `uint32_t`
 - Builds an array of the parsed `uint32_t`'s
 - Sorts the array
 - Prints the sorted array to `stdout`
- ❖ Hint: use `man` to read about `getline`, `sscanf`, `realloc`, and `qsort`

```
bash$ cat in.txt
1213
3231
000005
52
bash$ ./extra1 in.txt
5
52
1213
3231
bash$
```

Extra Exercise #2

❖ Write a program that:

■ Loops forever; in each loop:

- Prompt the user to input a filename
- Reads a filename from `stdin`
- Opens and reads the file
- Prints its contents to `stdout` in the format shown:

```
00000000 50 4b 03 04 14 00 00 00 00 00 9c 45 26 3c f1 d5
00000010 68 95 25 1b 00 00 25 1b 00 00 0d 00 00 00 43 53
00000020 45 6c 6f 67 6f 2d 31 2e 70 6e 67 89 50 4e 47 0d
00000030 0a 1a 0a 00 00 00 0d 49 48 44 52 00 00 00 91 00
00000040 00 00 91 08 06 00 00 00 c3 d8 5a 23 00 00 00 09
00000050 70 48 59 73 00 00 0b 13 00 00 0b 13 01 00 9a 9c
00000060 18 00 00 0a 4f 69 43 43 50 50 68 6f 74 6f 73 68
00000070 6f 70 20 49 43 43 20 70 72 6f 66 69 6c 65 00 00
00000080 78 da 9d 53 67 54 53 e9 16 3d f7 de f4 42 4b 88
00000090 80 94 4b 6f 52 15 08 20 52 42 8b 80 14 91 26 2a
000000a0 21 09 10 4a 88 21 a1 d9 15 51 c1 11 45 45 04 1b
... etc ...
```

❖ Hints:

- Use `man` to read about `fgets`
- Or, if you're more courageous, try `man 3 readline` to learn about `libreadline.a` and Google to learn how to link to it