

## Last Time

### ■ Caches

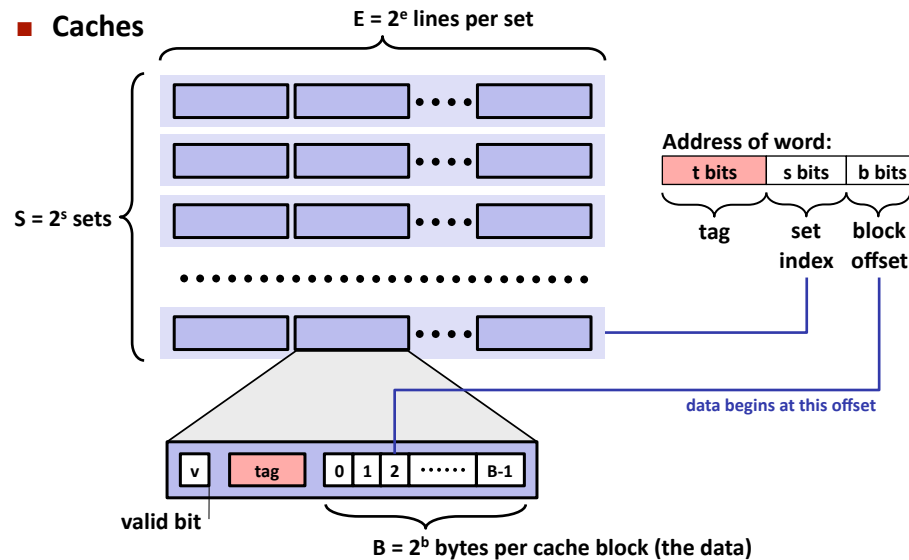

## Strided Access Problem

### ■ Example: L1 cache, Core 2 Duo

- 32 KB, 8-way associative, 64 byte cache block size
- What is S, E, B?  
 $B = 64 = 2^6$        $E = 8 = 2^3$   
 $S = (C/B)/E = (32K/64)/8 = (2^{15}/2^6)/2^3 = 2^6$   
 Tag size =  $m - \log_2 S - \log_2 B = 32 - 6 - 6 = 20$

### ■ Consider an array of ints accessed at stride $2^i$ , $i \geq 0$

- What is the smallest  $i$  such that only one set is used?  
 $i = (\log_2 S + \log_2 B - \log_2 \text{sizeof}(\text{int})) = 6 + 6 - 2 = 10$   
 $i = (\# \text{ bits for set} + \# \text{ bits for int offset in block}) = 6 + 4 = 10$   
*can fit up to 8 strides worth in 1 set ( $E = 8$ )*
- What happens if the stride is  $2^9$ ?  
*2 sets are used*

### ■ Source of two-power strides?

- Example: Column access of 2-D arrays (images!)

## Today

- *Linking* is the process of collecting and *combining* various pieces of code (modules) that make up a *program* (code and data) into a single file that be *loaded* (copied) into memory and *executed*
- Linkers are programs that do the linking

## Why Linkers? (programs that do the linking)

- **Modularity!**
  - Program can be written as a collection of smaller source files, rather than one monolithic mass
  - Can build libraries of common functions (more on this later)
    - e.g., math library, standard C library
- **Efficiency! Time: Separate Compilation**
  - Change one source file, compile, and then relink
  - No need to recompile other source files
- **Efficiency! Space: Libraries**
  - Common functions can be aggregated into a single file
  - Yet executable files and running memory images contain only code for the functions they actually use

## Example C Program

main.c

```
int buf[2] = {1, 2};

int main()
{
    swap();
    return 0;
}
```

swap.c

```
extern int buf[];

static int *bufp0 = &buf[0];
static int *bufp1;

void swap()
{
    int temp;

    bufp1 = &buf[1];
    temp = *bufp0;
    *bufp0 = *bufp1;
    *bufp1 = temp;
}
```

## Static Linking

- Programs are translated and linked using a *compiler driver*:

```
unix> gcc -O2 -g -o p main.c swap.c
unix> ./p
```

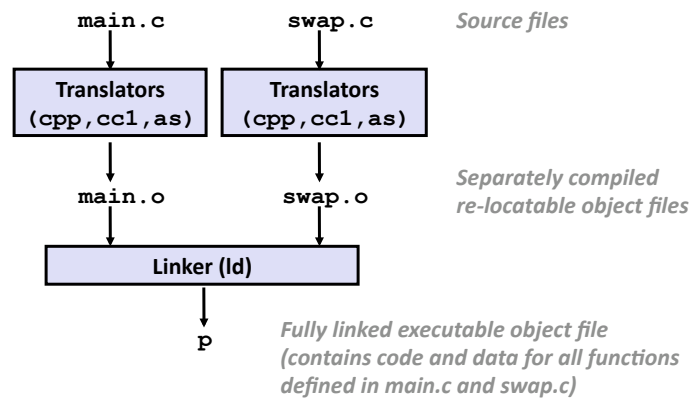

## What Do Linkers Do?

### ■ Step 1: Symbol resolution

- Programs define and reference *symbols* (variables and functions):
  - `void swap() {...} /* define symbol swap */`
  - `swap(); /* reference symbol swap */`
  - `int *xp = &x; /* define xp, reference x */`
- Symbol definitions are stored (by the compiler) in a *symbol table*
  - Symbol table is an array of structs
  - Each entry includes name, type, size, and location of symbol
- Linker associates each symbol reference with exactly one symbol definition

## What Do Linkers Do? (cont.)

### ■ Step 2: Relocation

- Merges separate code and data sections into single sections
- Relocates symbols from their relative locations in the `.o` files to their final absolute memory locations in the executable
- Updates all references to these symbols to reflect their new positions

## Three Kinds of Object Files (Modules)

- **Relocatable object file (.o file)**
  - Contains code and data in a form that can be combined with other relocatable object files to form executable object file (static linking)
  - Each .o file is produced from *exactly one source (.c) file*
- **Executable object file**
  - Contains code and data in a form that can be copied directly into memory and then executed
- **Shared object file (.so file)**
  - Special type of relocatable object file that can be loaded into memory and linked dynamically, at either load-time or run-time
  - Called *Dynamic Link Libraries* (DLLs) by Windows

## Executable and Linkable Format (ELF)

- **Standard binary format for object files**
- **Originally proposed by AT&T System V Unix**
  - Later adopted by BSD Unix variants and Linux
- **One unified format for**
  - Relocatable object files (.o),
  - Executable object files
  - Shared object files (.so)
- **Generic name: ELF binaries**

## ELF Object File Format

- **Elf header**
  - Word size, byte ordering, file type (.o, exec, .so), machine type, etc.
- **Segment header table**
  - Page size, virtual addresses, memory segments (sections), segment sizes
- **.text section**
  - Code
- **.rodata section**
  - Read only data: jump tables, ...
- **.data section**
  - Initialized global variables
- **.bss section**
  - Uninitialized global variables
  - “Block Started by Symbol”, “Better Save Space”
  - Has section header but occupies no space

ELF header
Segment header table (required for executables)
.text section
.rodata section
.data section
.bss section
.symtab section
.rel.text section
.rel.data section
.debug section
Section header table

## ELF Object File Format (cont.)

- **.symtab section**
  - Symbol table
  - Procedure and static variable names
  - Section names and locations
- **.rel.text section**
  - Relocation info for .text section
  - Addresses of instructions that will need to be modified in the executable
  - Instructions for modifying them
- **.rel.data section**
  - Relocation info for .data section
  - Addresses of pointer data that will need to be modified in the merged executable
- **.debug section**
  - Info for symbolic debugging (`gcc -g`)
- **Section header table**
  - Offsets and sizes of each section

ELF header
Segment header table (required for executables)
.text section
.rodata section
.data section
.bss section
.symtab section
.rel.text section
.rel.data section
.debug section
Section header table

## Linker Symbols

- **Global symbols**
  - Symbols defined by module *m* that can be referenced by other modules
  - E.g., non-`static` C functions and non-`static` global variables
- **External symbols**
  - Global symbols that are referenced by module *m* but defined by some other module
- **Local symbols**
  - Symbols that are defined and referenced exclusively by module *m*
  - E.g., C functions and variables defined with the `static` attribute
  - **Local linker symbols are *not* local program variables**

## Resolving Symbols

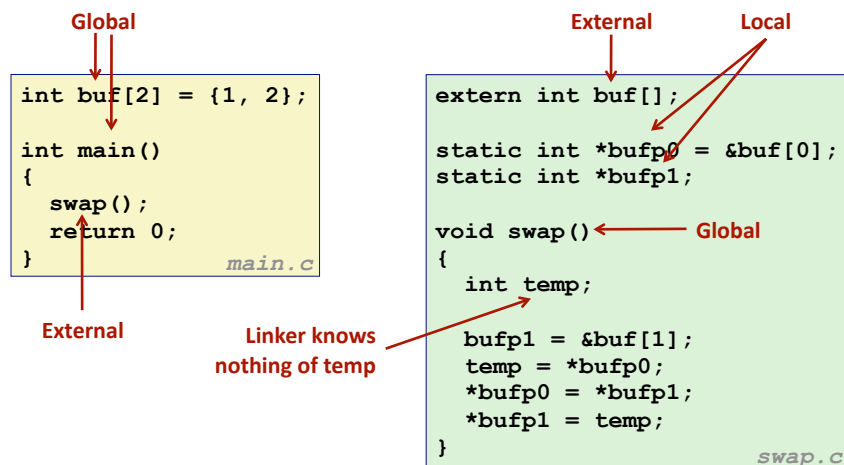

# Relocating Code and Data

## Relocatable Object Files

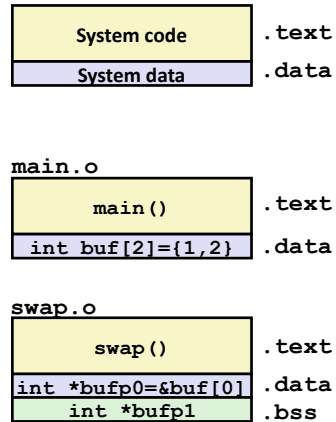

## Executable Object File

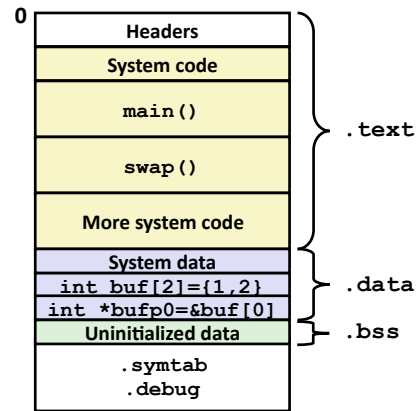

# Relocation Info (main) – before

main.c

```
int buf[2] = {1,2};

int main()
{
    swap();
    return 0;
}
```

main.o

```
00000000 <main>:
0: 55          push   %ebp
1: 89 e5      mov    %esp,%ebp
3: 83 ec 08   sub   $0x8,%esp
6: e8 fc ff ff call  7 <main+0x7>
7: R_386_PC32 swap
b: 31 c0     xor   %eax,%eax
d: 89 ec     mov   %ebp,%esp
f: 5d       pop   %ebp
10: c3       ret
```

Source: objdump

Disassembly of section .data:

```
00000000 <buf>:
0: 01 00 00 00 02 00 00 00
```

relocatable object  
r.offset = 0x7  
r.symbol = swap  
r.type = R\_386\_PC32

ADDR(.text) = 0x804883b4  
ADDR(r.symbol) = ADDR(swap) = 0x80483c8

reffaddr = ADDR(s) + r.offset = 0x804883b4 + 0x7 = 0x80483bb  
\*refptr = ADDR(r.symbol) + \*refptr - reffaddr = 0x80483c8 + (-4) - 0x80483bb = 0x9



## Relocation Info (main) – after

main.c

```
int buf[2] = {1,2};

int main()
{
    swap();
    return 0;
}
```

main.o

```
080483b4 <main>:
80483b4: 55                push   %ebp
80483b5: 89 e5             mov    %esp,%ebp
80483b7: 83 ec 08         sub   $0x8,%esp
80483ba: e8 09 00 00 00   call  80483c8 <swap>
80483bf: 31 c0             xor   %eax,%eax
80483c1: 89 ec             mov   %ebp,%esp
80483c3: 5d                pop   %ebp
80483c4: c3                ret
```

Source: objdump

Disassembly of section .data:

```
00000000 <buf>:
0: 01 00 00 00 02 00 00 00
```

ADDR(.text) = 0x804883b4

ADDR(r.symbol) = ADDR(swap) = 0x80483c8

$$\text{refaddr} = \text{ADDR}(s) + \text{r.offset} = 0x804883b4 + 0x7 = 0x80483bb$$

$$*\text{refptr} = \text{ADDR}(r.\text{symbol}) + *\text{refptr} - \text{refaddr} = 0x80483c8 + (-4) - 0x80483bb = 0x9$$

## Relocation Info (swap, .text)

swap.c

```
extern int buf[];

static int *bufp0 =
    &buf[0];
static int *bufp1;

void swap()
{
    int temp;

    bufp1 = &buf[1];
    temp = *bufp0;
    *bufp0 = *bufp1;
    *bufp1 = temp;
}
```

swap.o

Disassembly of section .text:

```
00000000 <swap>:
0: 55                push  %ebp
1: 8b 15 00 00 00 00 mov  0x0,%edx // %edx = *bufp0
3: R_386_32 bufp0
7: a1 04 00 00 00 00 mov  0x4,%eax // %eax = buf[1]
8: R_386_32 buf
c: 89 e5             mov  %esp,%ebp
e: c7 05 00 00 00 00 movl $0x4,0x0 // bufp1 = &buf[1]
14: 04 00 00 00
10: R_386_32 bufp1
14: R_386_32 buf
18: 89 ec             mov  %ebp,%esp
1a: 8b 0a             mov  (%edx),%ecx // temp = *bufp0
1c: 89 02             mov  %eax,(%edx) // *bufp0 = buf[1]
1e: a1 00 00 00 00 00 mov  0x0,%eax // %eax = *bufp1
1f: R_386_32 bufp1
23: 89 08             mov  %ecx,(%eax) // *bufp1 = temp
25: 5d                pop  %ebp
26: c3                ret
```

## Relocation Info (swap, .data)

swap.c

```
extern int buf[];

static int *bufp0 =
    &buf[0];
static int *bufp1;

void swap()
{
    int temp;

    bufp1 = &buf[1];
    temp = *bufp0;
    *bufp0 = *bufp1;
    *bufp1 = temp;
}
```

Disassembly of section .data:

```
00000000 <bufp0>:
    0:  00 00 00 00

    0:  R_386_32 buf
```

## Executable After Relocation (.text)

```
080483b4 <main>:
80483b4:  55                push   %ebp
80483b5:  89 e5             mov    %esp,%ebp
80483b7:  83 ec 08         sub   $0x8,%esp
80483ba:  e8 09 00 00 00   call  80483c8 <swap>
80483bf:  31 c0            xor   %eax,%eax
80483c1:  89 ec            mov   %ebp,%esp
80483c3:  5d                pop   %ebp
80483c4:  c3                ret

080483c8 <swap>:
80483c8:  55                push   %ebp
80483c9:  8b 15 5c 94 04 08 mov   0x804945c,%edx
80483cf:  a1 58 94 04 08   mov   0x8049458,%eax
80483d4:  89 e5             mov   %esp,%ebp
80483d6:  c7 05 48 95 04 08 movl  $0x8049458,0x8049548
80483dc:  58 94 04 08      mov   %edx,%eax
80483e0:  89 ec            mov   %ebp,%esp
80483e2:  8b 0a             mov   (%edx),%ecx
80483e4:  89 02             mov   %eax,(%edx)
80483e6:  a1 48 95 04 08   mov   0x8049548,%eax
80483eb:  89 08             mov   %ecx,(%eax)
80483ed:  5d                pop   %ebp
80483ee:  c3                ret
```

## Executable After Relocation (.data)

Disassembly of section .data:

```
08049454 <buf>:
8049454:    01 00 00 00 02 00 00 00

0804945c <bufp0>:
804945c:    54 94 04 08
```

In another file, where bufp1 resides:

```
08049548 <bufp1>:
8049548:    58 94 04 08
```

## Strong and Weak Symbols

- Program symbols are either strong or weak
  - **Strong**: procedures and initialized globals
  - **Weak**: uninitialized globals

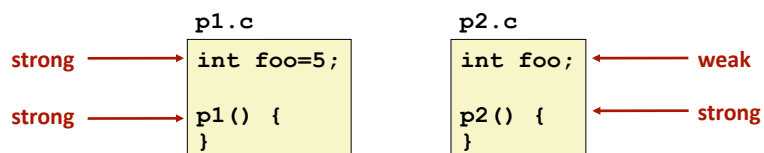

## Linker's Symbol Rules

- **Rule 1: Multiple strong symbols are not allowed**
  - Each item can be defined only once
  - Otherwise: Linker error
  
- **Rule 2: Given a strong symbol and multiple weak symbol, choose the strong symbol**
  - References to the weak symbol resolve to the strong symbol
  
- **Rule 3: If there are multiple weak symbols, pick an arbitrary one**
  - Can override this with `gcc -fno-common`

## Linker Puzzles

```
int x;
p1() {}
```

```
p1() {}
```

Link time error: two strong symbols (**p1**)

```
int x;
p1() {}
```

```
int x;
p2() {}
```

References to **x** will refer to the same uninitialized int. Is this what you really want?

```
int x;
int y;
p1() {}
```

```
double x;
p2() {}
```

Writes to **x** in **p2** might overwrite **y**!  
Evil!

```
int x=7;
int y=5;
p1() {}
```

```
double x;
p2() {}
```

Writes to **x** in **p2** will overwrite **y**!  
Nasty!

```
int x=7;
p1() {}
```

```
int x;
p2() {}
```

References to **x** will refer to the same initialized variable

**Nightmare scenario: two identical weak structs, compiled by different compilers with different alignment rules**

## Global Variables

- **Avoid if you can**
  
- **Otherwise**
  - Use `static` if you can
  - Initialize if you define a global variable
  - Use `extern` if you use external global variable

## Packaging Commonly Used Functions

- **How to package functions commonly used by programmers?**
  - Math, I/O, memory management, string manipulation, etc.
  
- **Awkward, given the linker framework so far:**
  - **Option 1:** Put all functions into a single source file
    - Programmers link big object file into their programs
    - Space and time inefficient
  - **Option 2:** Put each function in a separate source file
    - Programmers explicitly link appropriate binaries into their programs
    - More efficient, but burdensome on the programmer

## Solution: Static Libraries

### ■ Static libraries (.a archive files)

- Concatenate related relocatable object files into a single file with an index (called an *archive*)
- Enhance linker so that it tries to resolve unresolved external references by looking for the symbols in one or more archives
- If an archive member file resolves reference, link into executable

## Creating Static Libraries

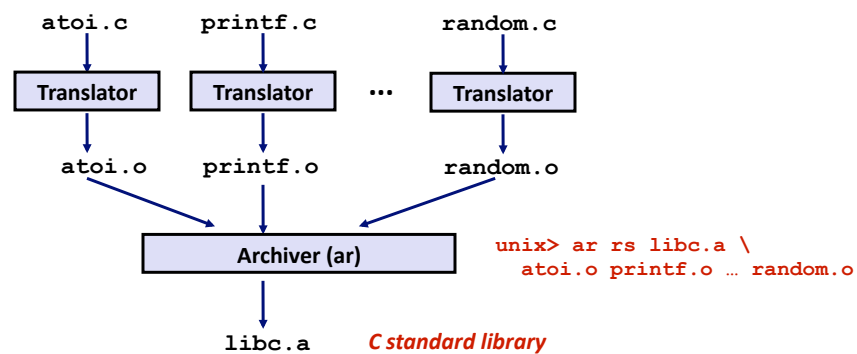

- Archiver allows incremental updates
- Recompile function that changes and replaces .o file in archive

## Commonly Used Libraries

### libc.a (the C standard library)

- 8 MB archive of 900 object files
- I/O, memory allocation, signal handling, string handling, data and time, random numbers, integer math

### libm.a (the C math library)

- 1 MB archive of 226 object files
- floating point math (sin, cos, tan, log, exp, sqrt, ...)

```
% ar -t /usr/lib/libc.a | sort
...
fork.o
...
fprintf.o
fpu_control.o
fputc.o
freopen.o
fscanf.o
fseek.o
fstab.o
...
```

```
% ar -t /usr/lib/libm.a | sort
...
e_acos.o
e_acosf.o
e_acosh.o
e_acoshf.o
e_acoshl.o
e_acosl.o
e_asin.o
e_asinf.o
e_asinl.o
...
```

## Linking with Static Libraries

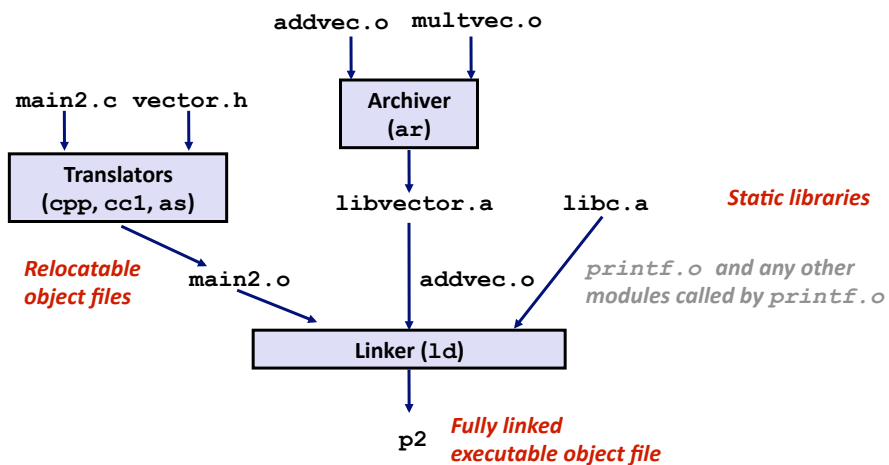

## Using Static Libraries

- **Linker's algorithm for resolving external references:**
  - Scan `.o` files and `.a` files in the command line order
  - During the scan, keep a list of the current unresolved references
  - As each new `.o` or `.a` file, *obj*, is encountered, try to resolve each unresolved reference in the list against the symbols defined in *obj*
  - If any entries in the unresolved list at end of scan, then error
  
- **Problem:**
  - Command line order matters!
  - Moral: put libraries at the end of the command line

```
unix> gcc -L. libtest.o -lmine
unix> gcc -L. -lmine libtest.o
libtest.o: In function `main':
libtest.o(.text+0x4): undefined reference to `libfun'
```

## Loading Executable Object Files

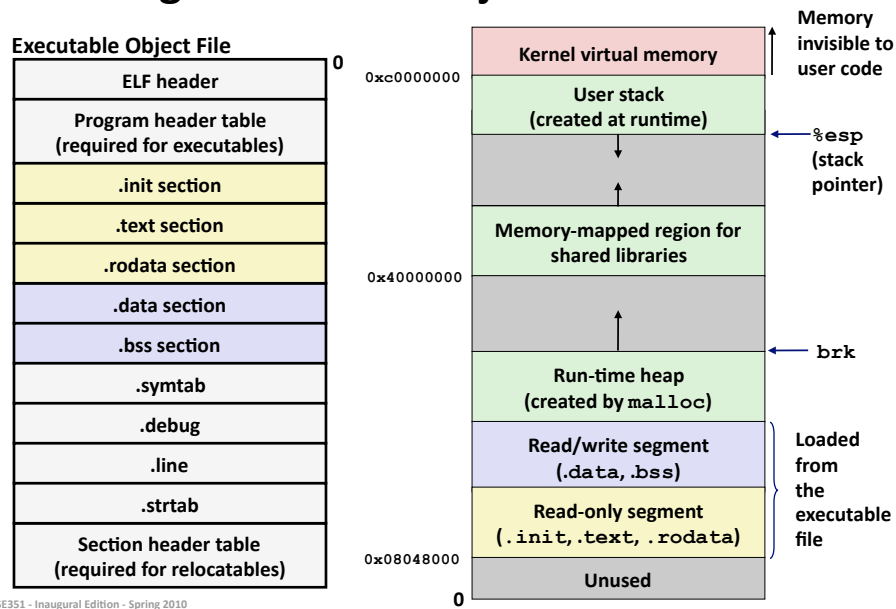



## Shared Libraries

- **Static libraries have the following disadvantages:**
  - Duplication in the stored executables (every function need std libc)
  - Duplication in the running executables
  - Minor bug fixes of system libraries require each application to explicitly relink
  
- **Modern Solution: Shared Libraries**
  - Object files that contain code and data that are loaded and linked into an application *dynamically*, at either *load-time* or *run-time*
  - Also called: dynamic link libraries, DLLs, .so files

## Dynamic Linking at Load-time

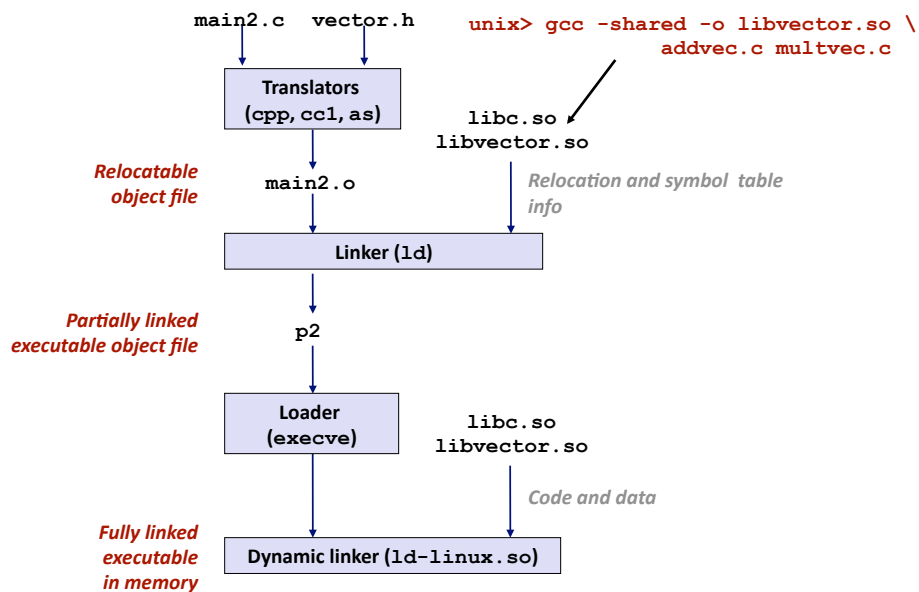

## Shared Libraries (cont.)

- **Dynamic linking can occur when executable is first loaded and run (load-time linking)**
  - Common case for Linux, handled automatically by the dynamic linker (`ld-linux.so`)
  - Standard C library (`libc.so`) usually dynamically linked
- **Dynamic linking can also occur after program has begun (run-time linking – *outside the scope of this course*)**
  - In Unix, this is done by calls to the `dlopen()` interface
    - High-performance web servers
    - Runtime library interpositioning
- **Shared library routines can be shared by multiple processes**
  - More on this when we learn about virtual memory