

Lectures 17-18

- Today:
 - More caches

1

How will execution time grow with SIZE?

```
int array[SIZE];
int A = 0;

for (int i = 0 ; i < 200000 ; ++ i) {
    for (int j = 0 ; j < SIZE ; ++ j) {
        A += array[j];
    }
}
```

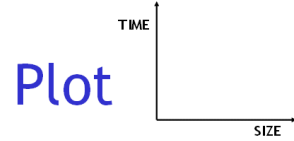

2

Actual Data

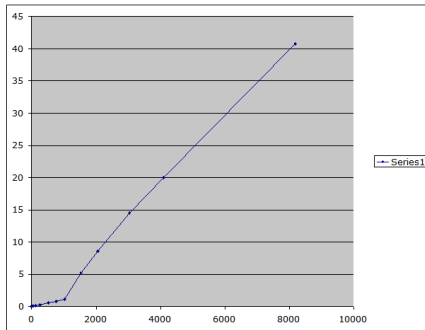

3

How can we find data in the cache?

- The second question was how to determine whether or not the data we're interested in is already stored in the cache.
- If we want to read memory address i , we can use the mod trick to determine which cache block would contain i .
- But other addresses might also map to the same cache block. How can we distinguish between them?
- For instance, cache block 2 could contain data from addresses 2, 6, 10 or 14.

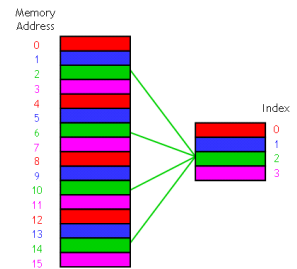

4

Adding tags

- We need to add **tags** to the cache, which supply the rest of the address bits to let us distinguish between different memory locations that map to the same cache block.

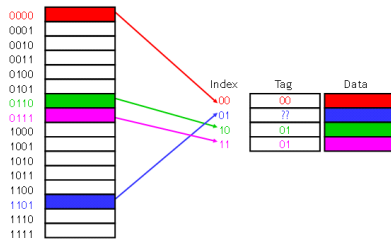

5

One more detail: the valid bit

- When started, the cache is empty and does not contain valid data.
- We should account for this by adding a **valid bit** for each cache block.
 - When the system is initialized, all the valid bits are set to 0.
 - When data is loaded into a particular cache block, the corresponding valid bit is set to 1.

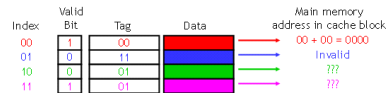

- So the cache contains more than just copies of the data in memory; it also has bits to help us find data within the cache and verify its validity.

6

What happens on a cache hit

- When the CPU tries to read from memory, the address will be sent to a **cache controller**.
 - The lowest k bits of the address will index a block in the cache.
 - If the block is valid and the tag matches the upper $(m - k)$ bits of the m -bit address, then that data will be sent to the CPU.
- Here is a diagram of a 32-bit memory address and a 2^{10} -byte cache.

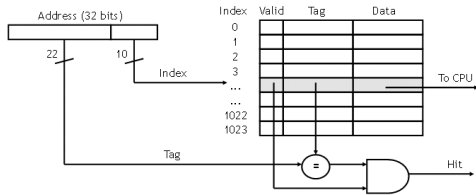

7

Loading a block into the cache

- After data is read from main memory, putting a copy of that data into the cache is straightforward.
 - The lowest k bits of the address specify a cache block.
 - The upper $(m - k)$ address bits are stored in the block's tag field.
 - The data from main memory is stored in the block's data field.
 - The valid bit is set to 1.

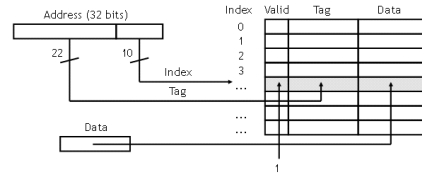

8

What if the cache fills up?

- Our third question was what to do if we run out of space in our cache, or if we need to reuse a block for a different memory address.
- We answered this question implicitly on the last page!
 - A miss causes a new block to be loaded into the cache, automatically overwriting any previously stored data.
 - This is a **least recently used** replacement policy, which assumes that older data is less likely to be requested than newer data.
- We'll see a few other policies next.

9

How big is the cache?

Suppose we have a byte-addressable machine with 16-bit addresses with a cache with the following characteristics:

- It is **direct-mapped**
- Each block holds **one byte**
- The cache index is the **four** least significant bits

Two questions:

- How many blocks does the cache hold?
- How many bits of storage are required to build the cache (e.g., for the data array, tags, etc.)?

10

How big is the cache?

For a byte-addressable machine with 16-bit addresses with a cache with the following characteristics:

- It is **direct-mapped** (as discussed last time)
- Each block holds **one byte**
- The cache index is the **four** least significant bits

Two questions:

- How many blocks does the cache hold?

4-bit index $\rightarrow 2^4 = 16$ blocks

- How many bits of storage are required to build the cache (e.g., for the data array, tags, etc.)?

**tag size = 12 bits (16 bit address - 4 bit index)
(12 tag bits + 1 valid bit = 8 data bits) \times 16 blocks = 21 bits \times 16 = 336 bits**

11

More cache organizations



Now we'll explore some alternate cache organizations.

- How can we take advantage of spatial locality too?
- How can we reduce the number of potential conflicts?
- We'll first motivate it with a brief discussion about cache performance.

12

Memory System Performance

- To examine the performance of a memory system, we need to focus on a couple of important factors.
 - How long does it take to send data from the cache to the CPU?
 - How long does it take to copy data from memory into the cache?
 - How often do we have to access main memory?
- There are names for all of these variables.
 - The **hit time** is how long it takes data to be sent from the cache to the processor. This is usually fast, on the order of 1-3 clock cycles.
 - The **miss penalty** is the time to copy data from main memory to the cache. This often requires dozens of clock cycles (at least).
 - The **miss rate** is the percentage of misses.

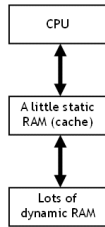

13

Average memory access time

- The **average memory access time**, or **AMAT**, can then be computed.

$$\text{AMAT} = \text{Hit time} + (\text{Miss rate} \times \text{Miss penalty})$$

This is just averaging the amount of time for cache hits and the amount of time for cache misses.

- How can we improve the average memory access time of a system?
 - Obviously, a lower AMAT is better.
 - Miss penalties are usually much greater than hit times, so the best way to lower AMAT is to reduce the **miss penalty** or the **miss rate**.
- However, AMAT should only be used as a general guideline. Remember that **execution time** is still the best performance metric.

14

Performance example

- Assume that 33% of the instructions in a program are data accesses. The cache hit ratio is 97% and the hit time is one cycle, but the miss penalty is 20 cycles.

$$\begin{aligned} \text{AMAT} &= \text{Hit time} + (\text{Miss rate} \times \text{Miss penalty}) \\ &= \\ &= \end{aligned}$$

- How can we reduce miss rate?

15

Performance example

- Assume data accesses only. The cache hit ratio is 97% and the hit time is one cycle, but the miss penalty is 20 cycles.

$$\begin{aligned} \text{AMAT} &= \text{Hit time} + (\text{Miss rate} \times \text{Miss penalty}) \\ &= 1 \text{ cycle} + (3\% \times 20 \text{ cycles}) \\ &= 1.6 \text{ cycles} \end{aligned}$$

- If the cache was perfect and never missed, the AMAT would be one cycle. But even with just a 3% miss rate, the AMAT here increases 1.6 times!
- How can we reduce miss rate?

16

Spatial locality

- One-byte cache blocks don't take advantage of **spatial locality**, which predicts that an access to one address will be followed by an access to a nearby address.
- What can we do?

17

Spatial locality

- What we can do is make the cache block size **larger than one byte**.

- Here we use two-byte blocks, so we can load the cache with two bytes at a time.
- If we read from address 12, the data in addresses 12 and 13 would both be copied to cache block 2.

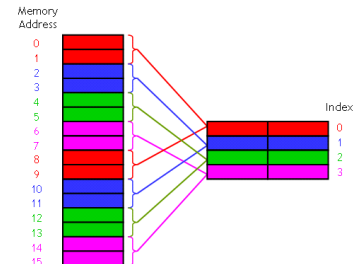

18

Block addresses

- Now how can we figure out where data should be placed in the cache?
- It's time for **block addresses!** If the cache block size is 2^n bytes, we can conceptually split the main memory into 2^n -byte chunks too.
- To determine the block address of a byte address i , you can do the integer division $i / 2^n$
- Our example has two-byte cache blocks, so we can think of a 16-byte main memory as an "8-block" main memory instead.
- For instance, memory addresses 12 and 13 both correspond to block address 6, since $12 / 2 = 6$ and $13 / 2 = 6$.

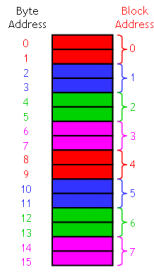

19

Cache mapping

- Once you know the block address, you can map it to the cache as before: find the remainder when the block address is divided by the number of cache blocks.
- In our example, memory block 6 belongs in cache block 2, since $6 \bmod 4 = 2$.
- This corresponds to placing data from memory byte addresses 12 and 13 into cache block 2.

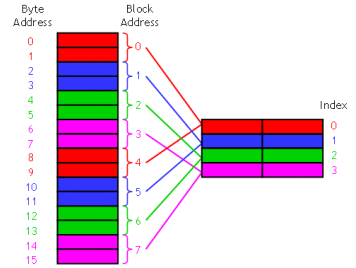

20

Data placement within a block

- When we access one byte of data in memory, we'll copy its entire *block* into the cache, to hopefully take advantage of spatial locality.
- In our example, if a program reads from byte address 12 we'll load all of memory block 6 (both addresses 12 and 13) into cache block 2.
- Note byte address 13 corresponds to the same memory block address! So a read from address 13 will also cause memory block 6 (addresses 12 and 13) to be loaded into cache block 2.
- To make things simpler, byte i of a memory block is always stored in byte i of the corresponding cache block.

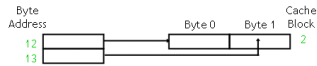

21

Locating data in the cache

- Let's say we have a cache with 2^k blocks, each containing 2^n bytes.
- We can determine where a byte of data belongs in this cache by looking at its address in main memory.
 - k bits of the address will select one of the 2^k cache blocks.
 - The lowest n bits are now a **block offset** that decides which of the 2^n bytes in the cache block will store the data.

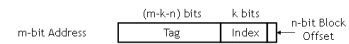

- Our example used a 2^2 -block cache with 2^1 bytes per block. Thus, memory address 13 (101) would be stored in byte 1 of cache block 2.

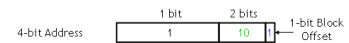

22

A picture

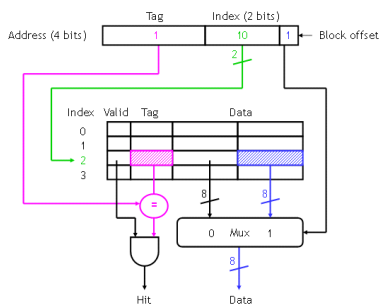

23

An exercise

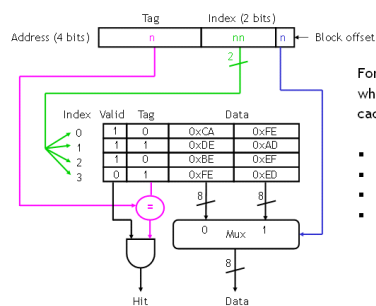

For the addresses below, what byte is read from the cache (or is there a miss)?

- 1010
- 1110
- 0001
- 1101

24

An exercise

Index	Valid	Tag	Data
0	1	0	0xCA 0xFE
1	1	1	0xDE 0xAD
2	1	0	0xEE 0xEF
3	0	1	0xFE 0xED

For the addresses below, what byte is read from the cache (or is there a miss)?

- 1010 (0xDE)
- 1110 (miss, invalid)
- 0001 (0xFE)
- 1101 (miss, bad tag)

25

A diagram of a larger example cache

- Here is a cache with 1,024 blocks of 4 bytes each, and 32-bit memory addresses.

26

A larger example cache mapping

- Where would the byte from memory address 6146 be stored in this direct-mapped 2¹⁰-block cache with 2²-byte blocks?
- We can determine this with the binary force.
 - 6146 in binary is 00...01 1000 0000 00 10.
 - The lowest 2 bits, 10, mean this is the second byte in its block.
 - The next 10 bits, 1000000000, are the block number itself (512).
- Equivalently, you could use arithmetic instead.
 - The block offset is 6146 mod 4, which equals 2.
 - The block address is 6146/4 = 1536, so the index is 1536 mod 1024, or 512.

27

Lecture 18

- What is cache block (or line)?
- What is an index?
- What about offset?

- Today:
 - More cache organizations
- Later:
 - Dealing with writes
 - Virtual memory

28

A larger diagram of a larger example cache mapping

29

What goes in the rest of that cache block?

- The other three bytes of that cache block come from the same memory block, whose addresses must all have the same index (1000000000) and the same tag (00...01).

30

The rest of that cache block

- Again, byte i of a memory block is stored into byte i of the corresponding cache block.
 - In our example, memory block 1536 consists of byte addresses 6144 to 6147. So bytes 0-3 of the cache block would contain data from address 6144, 6145, 6146 and 6147 respectively.
 - You can also look at the lowest 2 bits of the memory address to find the block offsets.

Block offset	Memory address	Decimal
00	00..01 1000000000 00	6144
01	00..01 1000000000 01	6145
10	00..01 1000000000 10	6146
11	00..01 1000000000 11	6147

31

Disadvantage of direct mapping

- The direct-mapped cache is easy: indices and offsets can be computed with bit operators or simple arithmetic, because each memory address belongs in exactly one block.
- But, what happens if a program uses addresses 2, 6, 2, 6, 2, ...?

32

Disadvantage of direct mapping

- The direct-mapped cache is easy: indices and offsets can be computed with bit operators or simple arithmetic, because each memory address belongs in exactly one block.
- However, this isn't really flexible. If a program uses addresses 2, 6, 2, 6, 2, ..., then each access will result in a cache miss and a load into cache block 2.
- This cache has four blocks, but direct mapping might not let us use all of them.
- This can result in more misses than we might like.

33

A fully associative cache

- A **fully associative cache** permits data to be stored in any cache block, instead of forcing each memory address into one particular block.
 - When data is fetched from memory, it can be placed in any unused block of the cache.
 - This way we'll never have a conflict between two or more memory addresses which map to a single cache block.
- In the previous example, we might put memory address 2 in cache block 2, and address 6 in block 3. Then subsequent repeated accesses to 2 and 6 would all be hits instead of misses.
- If all the blocks are already in use, it's usually best to replace the **least recently used** one, assuming that if it hasn't used it in a while, it won't be needed again anytime soon.

34

CAM

The price of full associativity

- However, a fully associative cache is expensive to implement.
 - Because there is no index field in the address anymore, the *entire* address must be used as the tag, increasing the total cache size.
 - Data could be anywhere in the cache, so we must check the tag of every cache block. That's a lot of comparators!

35

Set associativity

- An intermediate possibility is a **set-associative cache**.
 - The cache is divided into groups of blocks, called **sets**.
 - Each memory address maps to exactly one set in the cache, but data may be placed in any block within that set.
- If each set has 2^x blocks, the cache is an **2^x -way associative cache**.
- Here are several possible organizations of an eight-block cache.

36

Locating a set associative block

- We can determine where a memory address belongs in an associative cache in a similar way as before.
- If a cache has 2^s sets and each block has 2^n bytes, the memory address can be partitioned as follows.

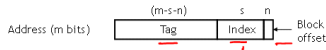

- Our arithmetic computations now compute a **set index**, to select a set within the cache instead of an individual block.

$$\text{Block Offset} = \text{Memory Address} \bmod 2^n$$

$$\text{Block Address} = \text{Memory Address} / 2^n$$

$$\text{Set Index} = \text{Block Address} \bmod 2^s$$

37

Example placement in set-associative caches

- Where would data from memory byte address 6195 be placed, assuming the eight-block cache designs below, with 16 bytes per block?
- 6195 in binary is $00\dots0110000$ **011** 0011.

3 block offset

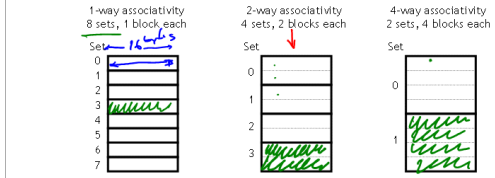

index 011

011 = 3

011 = 1

38

Example placement in set-associative caches

- Where would data from memory byte address 6195 be placed, assuming the eight-block cache designs below, with 16 bytes per block?
- 6195 in binary is $00\dots0110000$ **011** 0011.
- Each block has 16 bytes, so the **lowest 4 bits are the block offset**.
- For the 1-way cache, the next three bits (**011**) are the set index. For the 2-way cache, the next two bits (**11**) are the set index. For the 4-way cache, the next one bit (**1**) is the set index.
- The data may go in **any block**, shown in green, within the correct set.

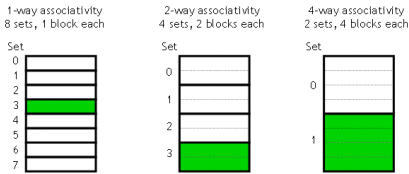

39

Block replacement

- Any empty block in the correct set may be used for storing data.
- If there are no empty blocks, which one should we replace?

miss

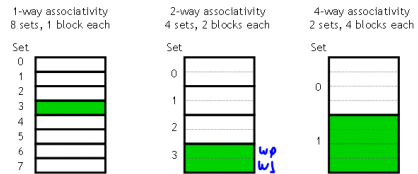

40

Block replacement

- Any empty block in the correct set may be used for storing data.
- If there are no empty blocks, the cache controller will attempt to replace the least recently used block, just like before.
- For highly associative caches, it's expensive to keep track of what's really the least recently used block, so some approximations are used. We won't get into the details.

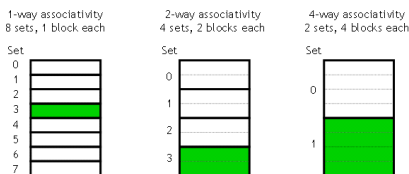

41

LRU example

NMRU

- Assume a fully-associative cache with two blocks, which of the following memory references miss in the cache.
- assume distinct addresses go to distinct blocks

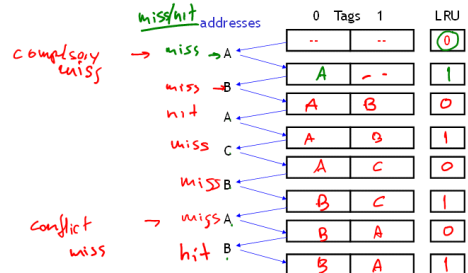

42

LRU example

- Assume a fully-associative cache with two blocks, which of the following memory references miss in the cache.
 - assume distinct addresses go to distinct blocks

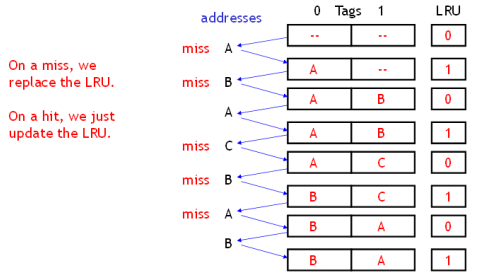

Set associative caches are a general idea

- By now you may have noticed the 1-way set associative cache is the same as a **direct-mapped** cache.
- Similarly, if a cache has 2^k blocks, a 2^k -way set associative cache would be the same as a **fully-associative** cache.

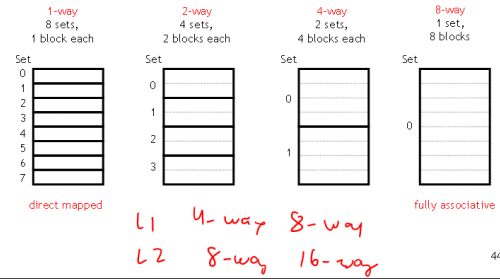

2-way set associative cache implementation

- How does an implementation of a 2-way cache compare with that of a fully-associative cache?

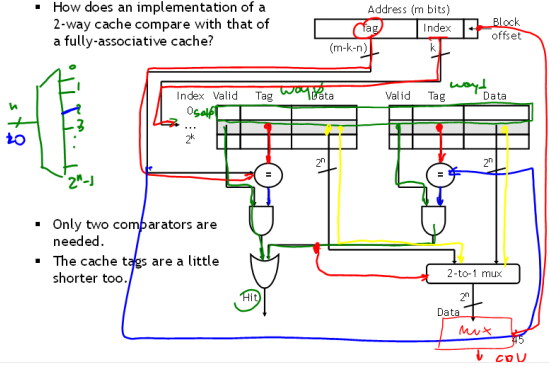

Summary

- Larger **block** sizes can take advantage of **spatial locality** by loading data from not just one address, but also nearby addresses, into the cache.
- Associative caches** assign each memory address to a particular set within the cache, but not to any specific block within that set.
 - Set sizes range from 1 (**direct-mapped**) to 2^k (**fully associative**).
 - Larger sets and higher associativity lead to fewer cache conflicts and lower miss rates, but they also increase the hardware cost.
 - In practice, 2-way through 16-way set-associative caches strike a good balance between lower miss rates and higher costs.
- Next, we'll talk more about measuring cache performance, and also discuss the issue of **writing** data to a cache.

How would you find out the associativity?

Hmm, what about writes?