

Lectures 19-20

- Today:
 - Writes
 - Cache performance?

Cache Writing & Performance

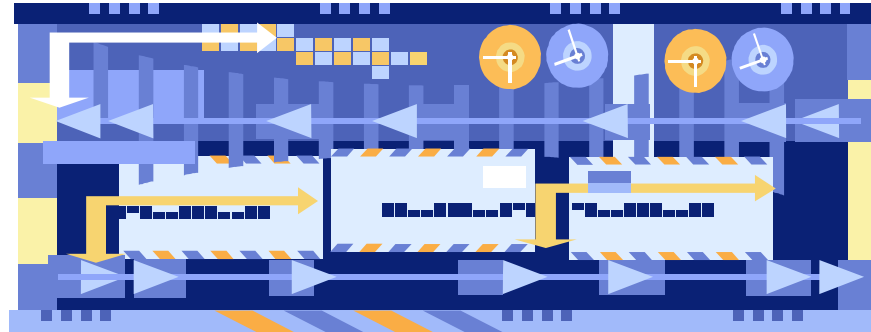

- We'll now cover:
 - Writing to caches: keeping memory consistent & write-allocation.
 - We'll try to quantify the benefits of different cache designs, and see how caches affect overall performance.
 - We'll also investigate some main memory organizations that can help increase memory system performance.
- Next, we'll talk about Virtual Memory, where memory is treated like a cache of the disk.

Four important questions

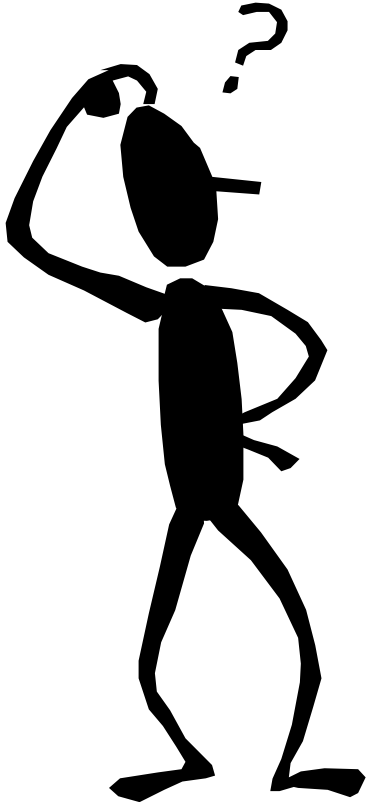

1. When we copy a block of data from main memory to the cache, where exactly should we put it?
2. How can we tell if a word is already in the cache, or if it has to be fetched from main memory first?
3. Eventually, the small cache memory might fill up. To load a new block from main RAM, we'd have to replace one of the existing blocks in the cache... which one?
4. How can *write* operations be handled by the memory system?

- We've answered the first 3. Now, we consider the 4th.

Writing to a cache

- Writing to a cache raises several additional issues.
- First, let's assume that the address we want to write to is already loaded in the cache. We'll assume a simple direct-mapped cache.

Index	V	Tag	Data	Address	Data
...				...	
110	1	11010	42803	1101 0110	42803
...				...	

- If we write a new value to that address, we can store the new data in the cache, and avoid an expensive main memory access.

Mem[214] = 21763

↓

Index	V	Tag	Data	Address	Data
...				...	
110	1	11010	21763	1101 0110	42803
...				...	

Inconsistent memory

- But now the cache and memory contain different, inconsistent data!
- How can we ensure that subsequent loads will return the right value?
- This is also problematic if other devices are sharing the main memory, as in a multiprocessor system.

Index	V	Tag	Data
...			
110	1	11010	21763
...			

Address	Data
...	
1101 0110	42803
...	

Write-through caches

- A **write-through cache** solves the inconsistency problem by forcing all writes to update both the cache *and* the main memory.

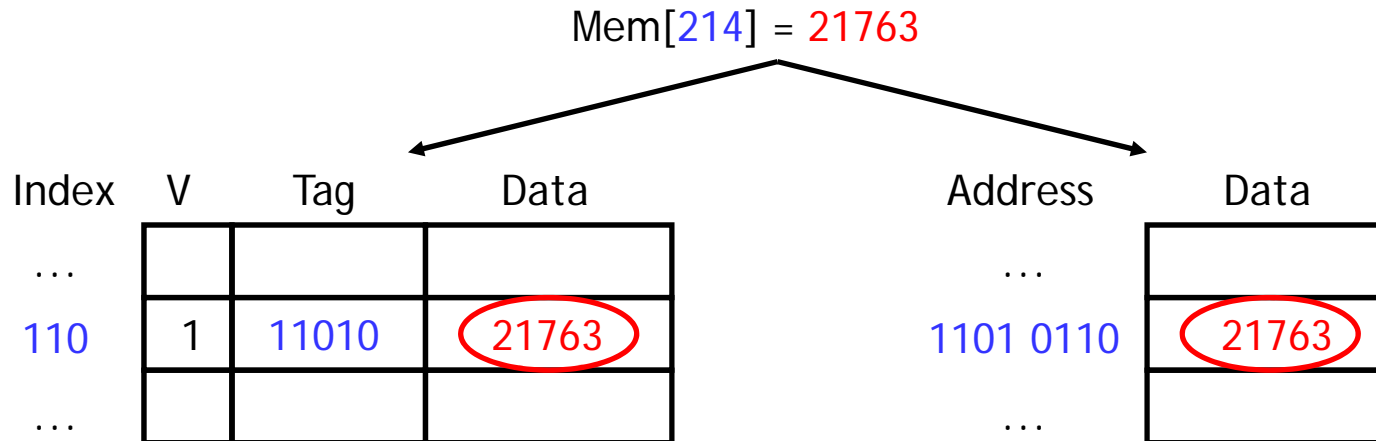

- This is simple to implement and keeps the cache and memory consistent.
- Why is this not so good?

Write-through caches

- A **write-through cache** solves the inconsistency problem by forcing all writes to update both the cache *and* the main memory.

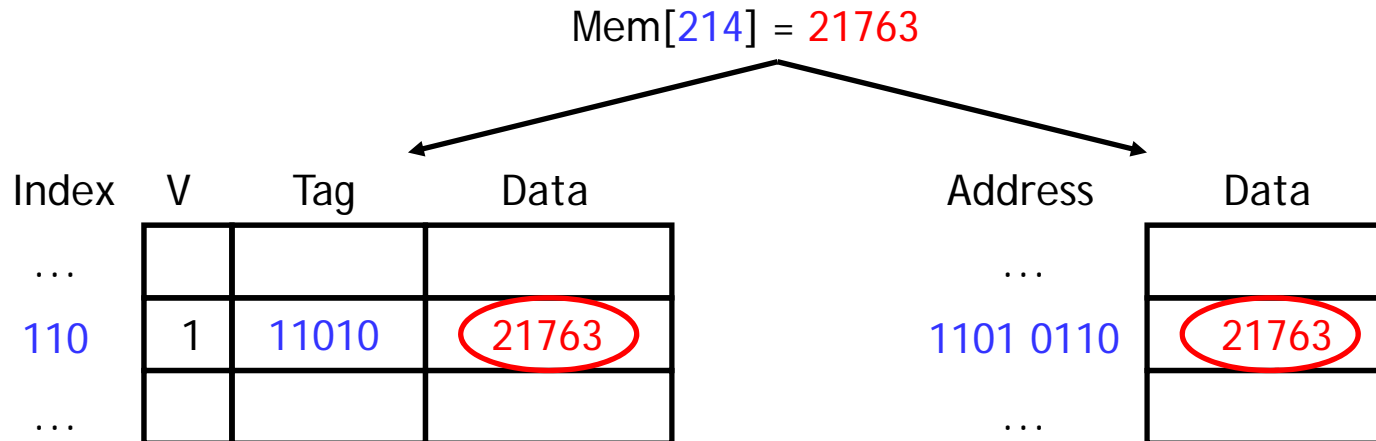

- This is simple to implement and keeps the cache and memory consistent.
- The bad thing is that forcing every write to go to main memory, we use up bandwidth between the cache and the memory.

Write buffers

- Write-through caches can result in slow writes, so processors typically include a **write buffer**, which queues pending writes to main memory and permits the CPU to continue.

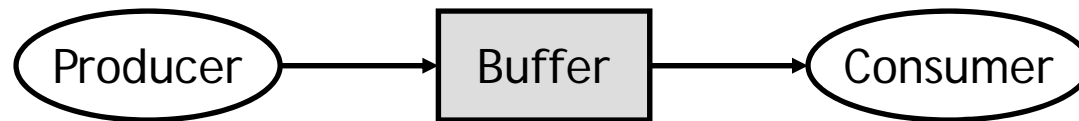

- Buffers are commonly used when two devices run at different speeds.
 - If a **producer** generates data too quickly for a **consumer** to handle, the extra data is stored in a buffer and the producer can continue on with other tasks, without waiting for the consumer.
 - Conversely, if the producer slows down, the consumer can continue running at full speed as long as there is excess data in the buffer.
- For us, the producer is the CPU and the consumer is the main memory.

Write-back caches

- In a **write-back cache**, the memory is not updated until the cache block needs to be replaced (*e.g.*, when loading data into a full cache set).
- For example, we might write some data to the cache at first, leaving it inconsistent with the main memory as shown before.
 - The cache block is marked “dirty” to indicate this inconsistency

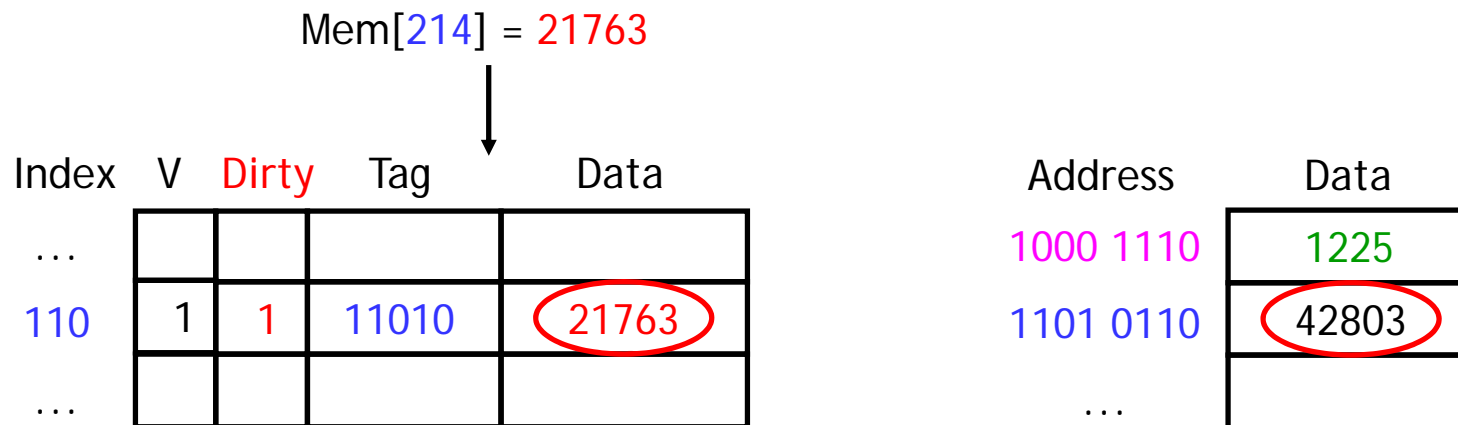

- Subsequent reads to the same memory address will be serviced by the cache, which contains the correct, updated data.

Finishing the write back

- We don't need to store the new value back to main memory unless the cache block gets replaced.
- For example, on a read from Mem[142], which maps to the same cache block, the modified cache contents will first be written to main memory.

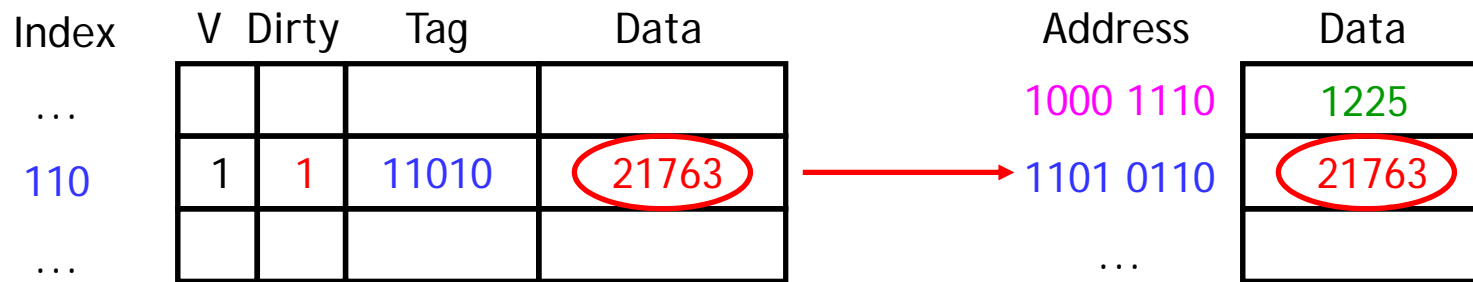

- Only then can the cache block be replaced with data from address 142.

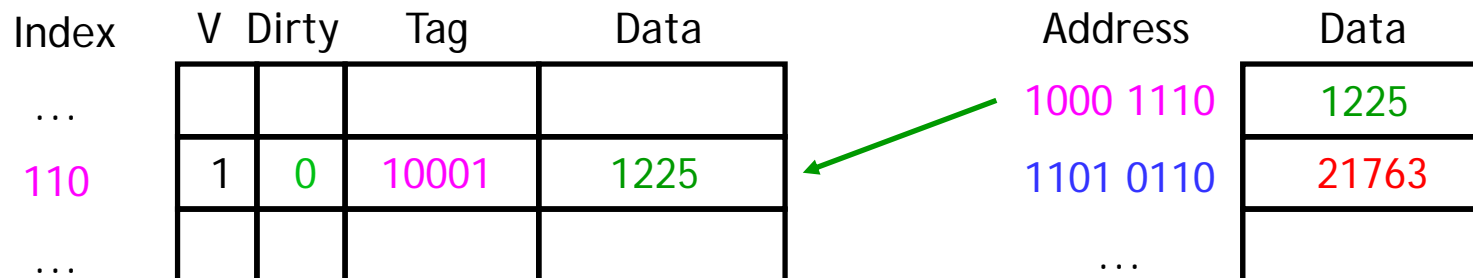

Write-back cache discussion

- The advantage of write-back caches is that not all write operations need to access main memory, as with write-through caches.
 - If a single address is frequently written to, then it doesn't pay to keep writing that data through to main memory.
 - If several bytes within the same cache block are modified, they will only force one memory write operation at write-back time.

Write misses

- A second scenario is if we try to write to an address that is not already contained in the cache; this is called a **write miss**.
- Let's say we want to store **21763** into Mem[**1101 0110**] but we find that address is not currently in the cache.

Index	V	Tag	Data	Address	Data
...				...	
110	1	00010	123456	1101 0110	6378
...				...	

- When we update Mem[**1101 0110**], should we *also* load it into the cache?

Write around caches (a.k.a. write-no-allocate)

- With a **write around** policy, the write operation goes directly to main memory *without* affecting the cache.

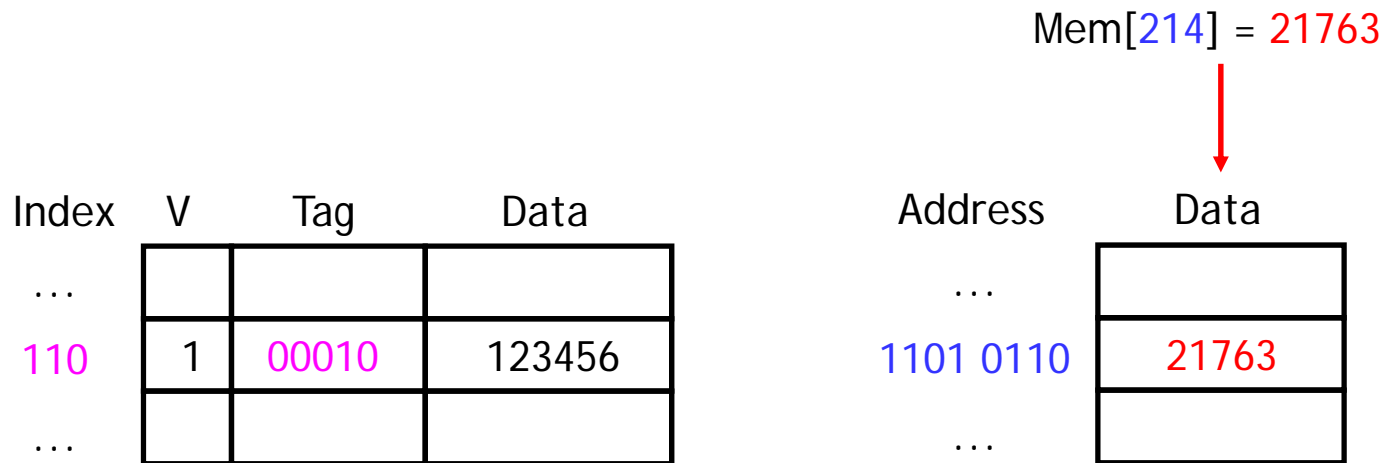

Write around caches (a.k.a. write-no-allocate)

- With a **write around** policy, the write operation goes directly to main memory *without* affecting the cache.

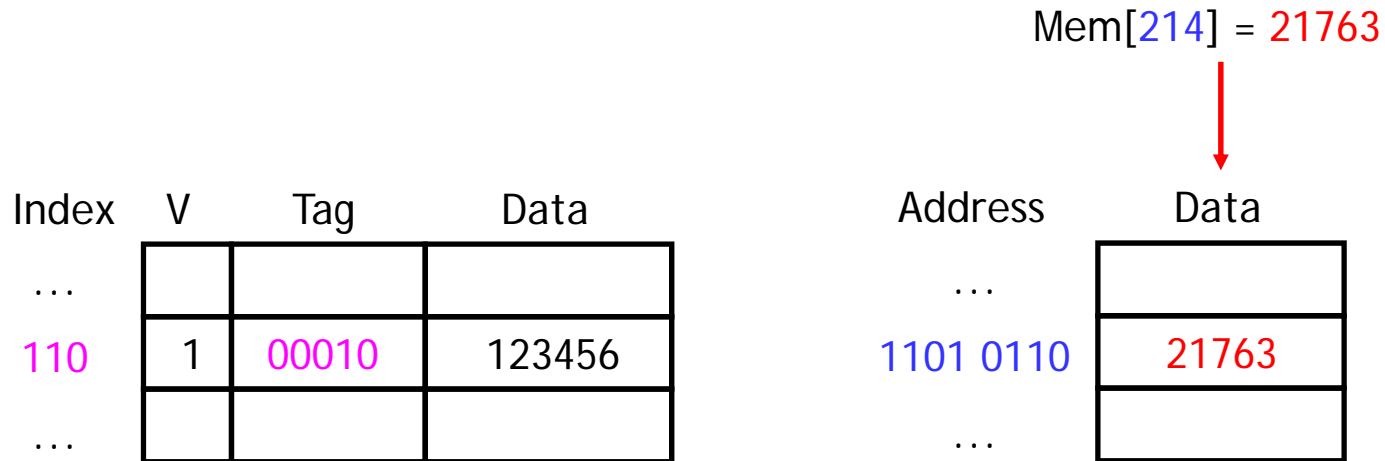

- This is good when data is written but not immediately used again, in which case there's no point to load it into the cache yet.

```
for (int i = 0; i < SIZE; i++)  
    a[i] = i;
```

Allocate on write

- An **allocate on write** strategy would instead load the newly written data into the cache.

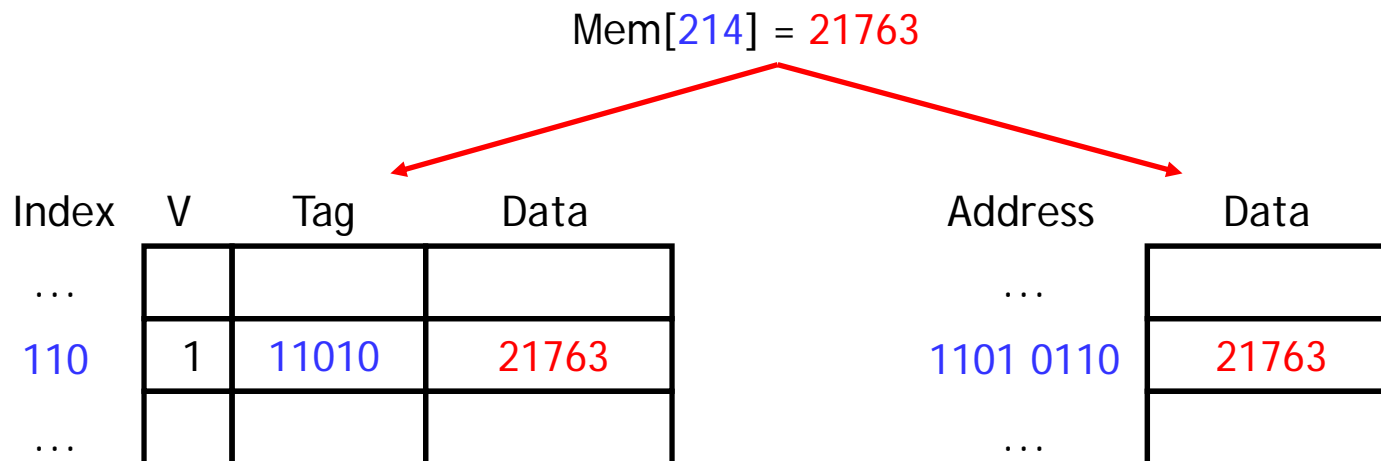

- If that data is needed again soon, it will be available in the cache.

Which is it?

- Given the following trace of accesses, can you determine whether the cache is **write-allocate** or **write-no-allocate**?
 - Assume A and B are distinct, and can be in the cache simultaneously.

Miss Load A

Miss Store B

Hit Store A

Hit Load A

Miss Load B

Hit Load B

Hit Load A

Which is it?

- Given the following trace of accesses, can you determine whether the cache is **write-allocate** or **write-no-allocate**?
 - Assume A and B are distinct, and can be in the cache simultaneously.

Miss Load A

Miss Store B

Hit Store A

Hit Load A

Miss Load B

Hit Load B

Hit Load A

Answer: Write-no-allocate

On a write-allocate cache this would be a hit

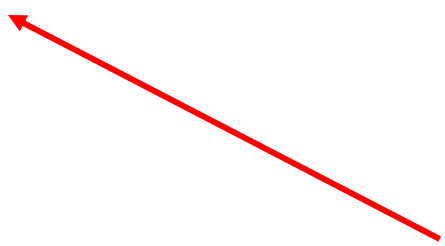

How Many Caches?

- Split Instruction/Data caches:

- Pro: No structural hazard between IF & MEM stages
 - A single-ported unified cache stalls fetch during load or store
- Con: Static partitioning of cache between instructions & data
 - Bad if working sets unequal: *e.g.*, `code/DATA` or `CODE/data`

- Cache Hierarchies:

- Trade-off between access time & hit rate
 - L1 cache can focus on fast access time (okay hit rate)
 - L2 cache can focus on good hit rate (okay access time)
- Such hierarchical design is another “big idea”

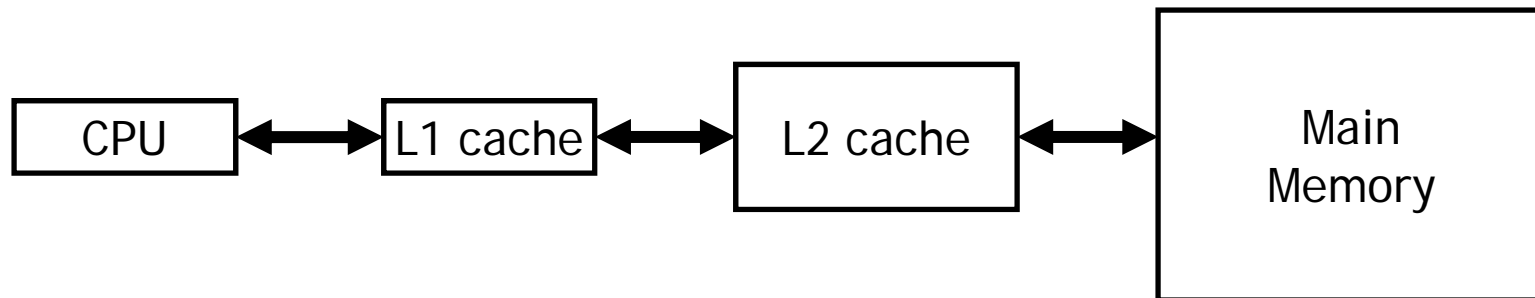

Opteron Vital Statistics

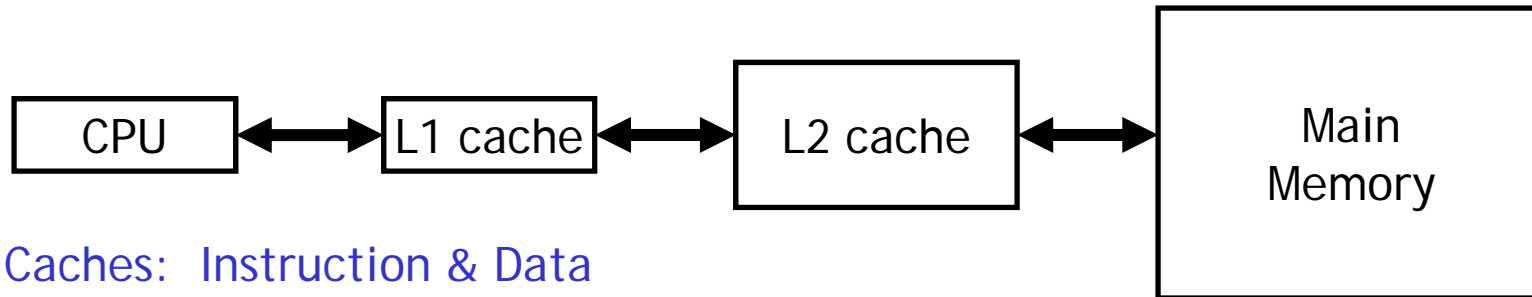

- L1 Caches: Instruction & Data
 - 64 kB
 - 64 byte blocks
 - 2-way set associative
 - 2 cycle access time
- L2 Cache:
 - 1 MB
 - 64 byte blocks
 - 4-way set associative
 - 16 cycle access time (total, not just miss penalty)
- Memory
 - 200+ cycle access time

Comparing cache organizations

- Like many architectural features, caches are evaluated experimentally.
 - As always, performance depends on the actual instruction mix, since different programs will have different memory access patterns.
 - Simulating or executing real applications is the most accurate way to measure performance characteristics.
- The graphs on the next few slides illustrate the simulated miss rates for several different cache designs.
 - Again lower miss rates are generally better, but remember that the miss rate is just one component of average memory access time and execution time.
 - You'll probably do some cache simulations if you take CSE471.



Associativity tradeoffs and miss rates

- As we saw last time, higher associativity means more complex hardware.
- But a highly-associative cache will also exhibit a lower miss rate.
 - Each set has more blocks, so there's less chance of a conflict between two addresses which both belong in the same set.
 - Overall, this will reduce AMAT and memory stall cycles.
- The textbook shows the miss rates decreasing as the associativity increases.

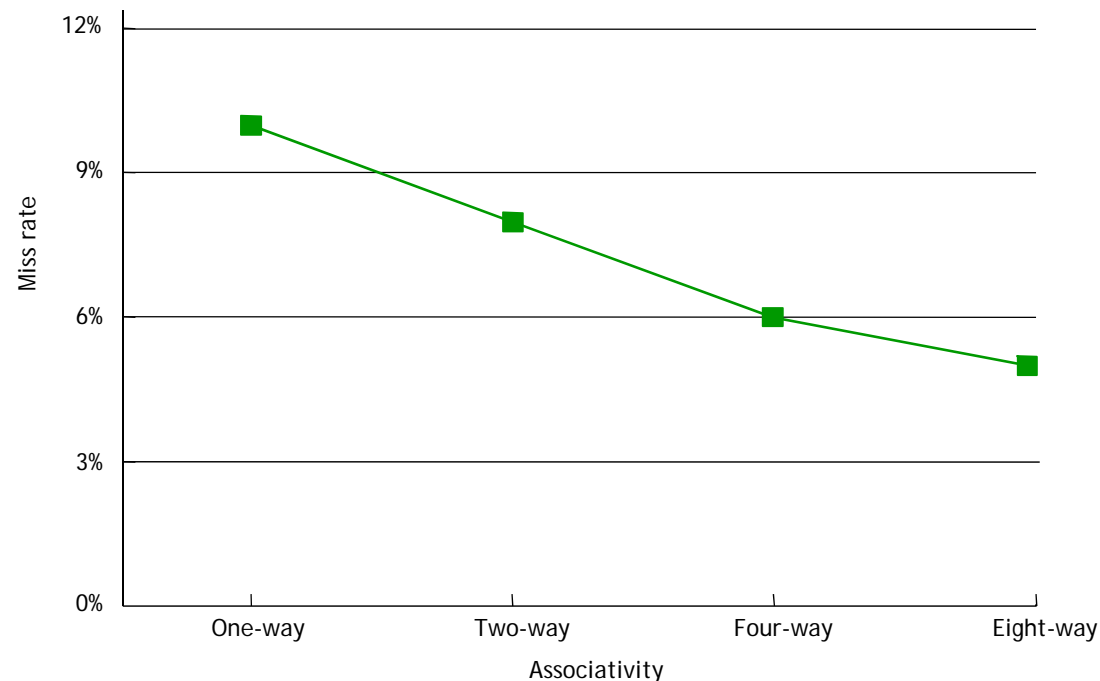

Cache size and miss rates

- The cache size also has a significant impact on performance.
 - The larger a cache is, the less chance there will be of a conflict.
 - Again this means the miss rate decreases, so the AMAT and number of memory stall cycles also decrease.
- The complete graph depicts the miss rate as a function of both the cache size and its associativity.

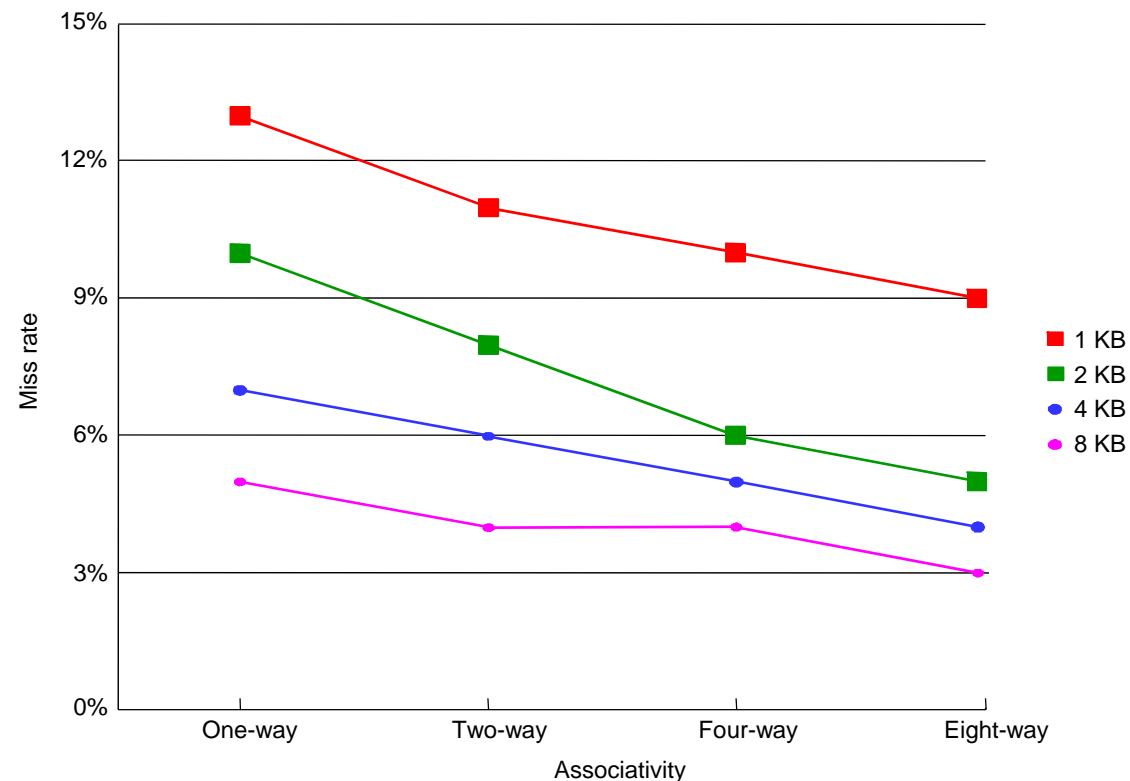

Block size and miss rates

- Finally, this graph shows miss rates relative to the block size and overall cache size.
 - Smaller blocks do not take maximum advantage of spatial locality.

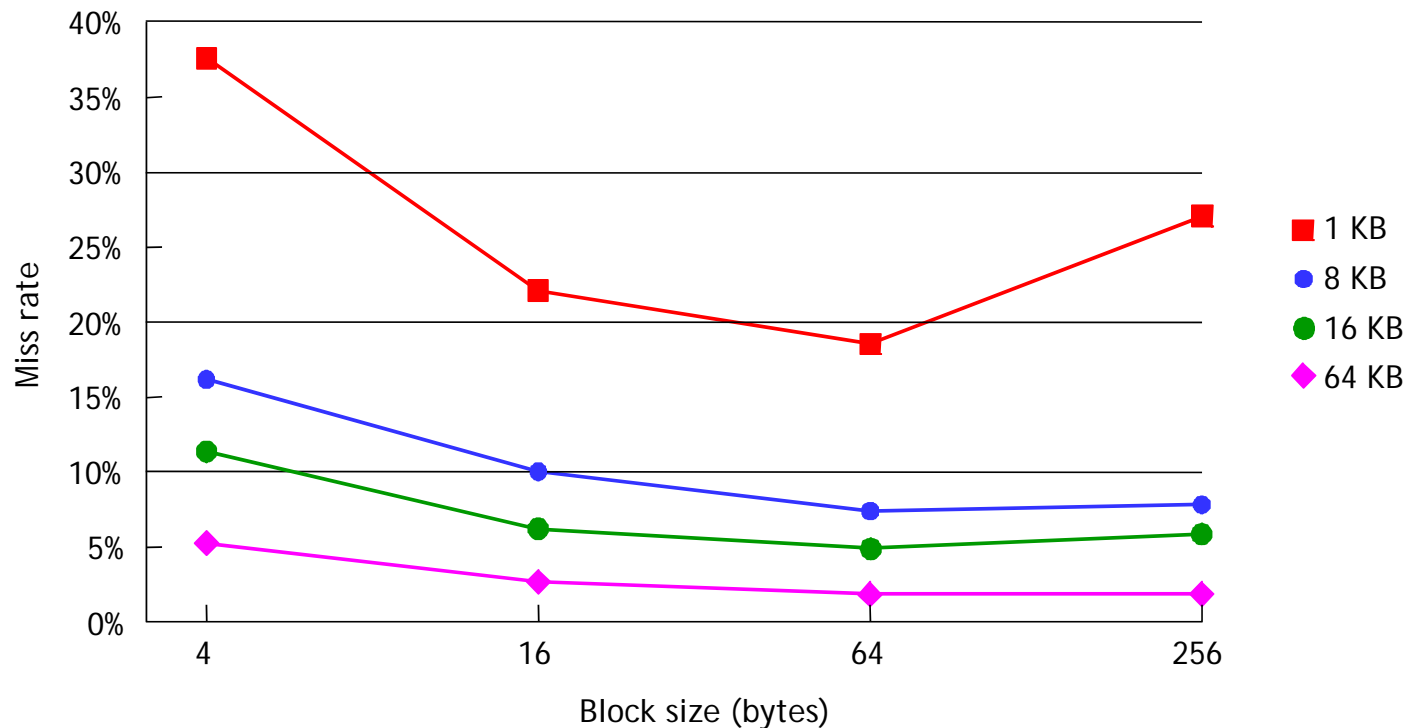

Block size and miss rates

- Finally, this graph shows miss rates relative to the block size and overall cache size.
 - Smaller blocks do not take maximum advantage of spatial locality.
 - But if blocks are *too* large, there will be fewer blocks available, and more potential misses due to conflicts.

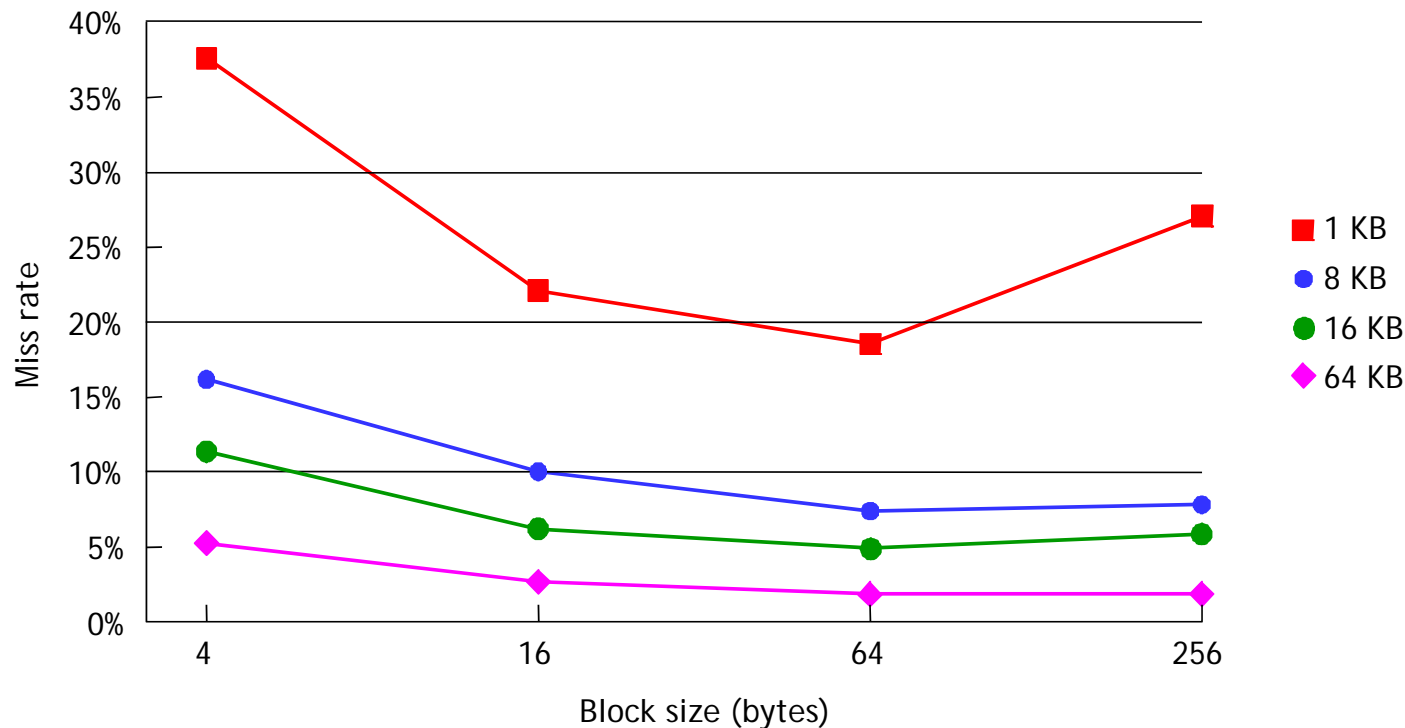

Memory and overall performance

- How do cache hits and misses affect overall system performance?
 - Assuming a hit time of one CPU clock cycle, program execution will continue normally on a cache hit. (Our earlier computations always assumed one clock cycle for an instruction fetch or data access.)
 - For cache misses, we'll assume the CPU must stall to wait for a load from main memory.
- The total number of stall cycles depends on the number of cache misses *and* the miss penalty.

Memory stall cycles = Memory accesses x miss rate x miss penalty

- To include stalls due to cache misses in CPU performance equations, we have to add them to the “base” number of execution cycles.

CPU time = (CPU execution cycles + Memory stall cycles) x Cycle time

Performance example

- Assume that 33% of the instructions in a program are data accesses. The cache hit ratio is 97% and the hit time is one cycle, but the miss penalty is 20 cycles.

$$\begin{aligned}\text{Memory stall cycles} &= \text{Memory accesses} \times \text{Miss rate} \times \text{Miss penalty} \\ &= 0.33 \mathbf{I} \times 0.03 \times 20 \text{ cycles} \\ &= 0.2 \mathbf{I} \text{ cycles}\end{aligned}$$

- If \mathbf{I} instructions are executed, then the number of wasted cycles will be $0.2 \times \mathbf{I}$.

This code is 1.2 times slower than a program with a “perfect” CPI of 1!

Memory systems are a bottleneck

CPU time = (CPU execution cycles + Memory stall cycles) x Cycle time

- Processor performance traditionally outpaces memory performance, so the memory system is often the system bottleneck.
- For example, with a base CPI of 1, the CPU time from the last page is:

$$\text{CPU time} = (1 + 0.2 \cdot 1) \times \text{Cycle time}$$

- What if we could *double* the CPU performance so the CPI becomes 0.5, but memory performance remained the same?

$$\text{CPU time} = (0.5 \cdot 1 + 0.2 \cdot 1) \times \text{Cycle time}$$

- The overall CPU time improves by just $1.2/0.7 = 1.7$ times!
- Refer back to Amdahl's Law.
 - Speeding up only part of a system has diminishing returns.

Basic main memory design

- There are some ways the main memory can be organized to reduce miss penalties and help with caching.
- For some concrete examples, let's assume the following three steps are taken when a cache needs to load data from the main memory.
 1. It takes 1 cycle to send an address to the RAM.
 2. There is a 15-cycle latency for each RAM access.
 3. It takes 1 cycle to return data from the RAM.
- In the setup shown here, the buses from the CPU to the cache and from the cache to RAM are all one word wide.
- If the cache has one-word blocks, then filling a block from RAM (*i.e.*, the miss penalty) would take 17 cycles.

$$1 + 15 + 1 = 17 \text{ clock cycles}$$

- The cache controller has to send the desired address to the RAM, wait and receive the data.

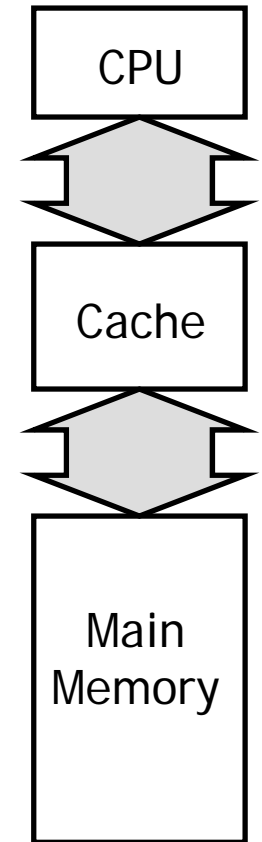

Miss penalties for larger cache blocks

- If the cache has four-word blocks, then loading a single block would need four individual main memory accesses, and a miss penalty of 68 cycles!

$$4 \times (1 + 15 + 1) = 68 \text{ clock cycles}$$

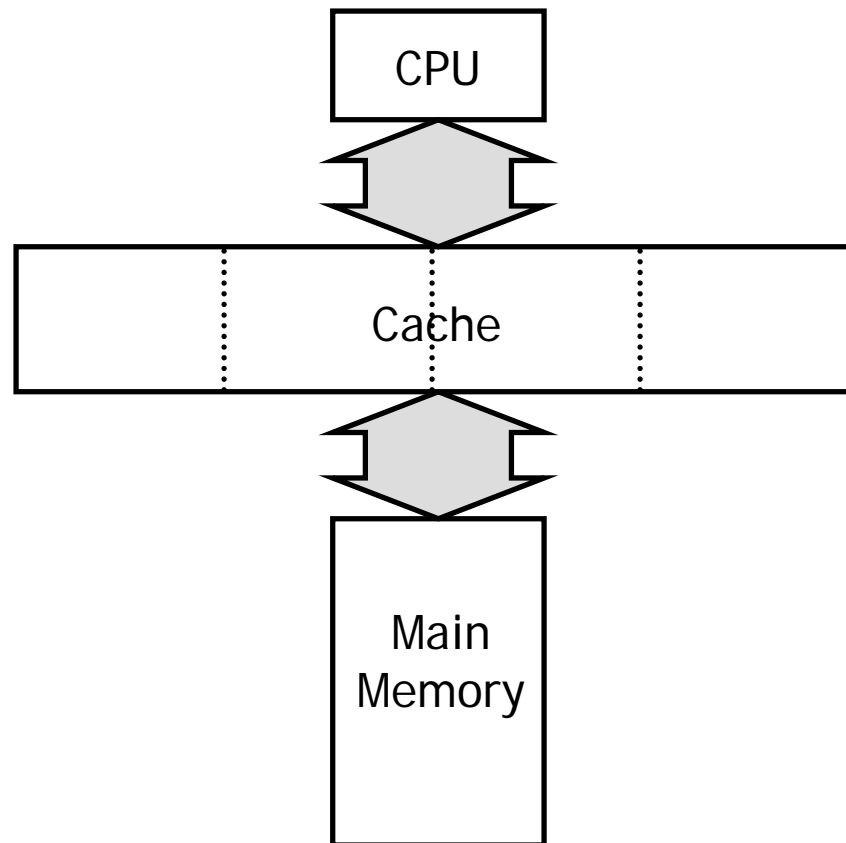

A wider memory

- A simple way to decrease the miss penalty is to widen the memory and its interface to the cache, so we can read multiple words from RAM in one shot.
- If we could read four words from the memory at once, a four-word cache load would need just 17 cycles.

$$1 + 15 + 1 = 17 \text{ cycles}$$

- The disadvantage is the cost of the wider buses—each additional bit of memory width requires another connection to the cache.

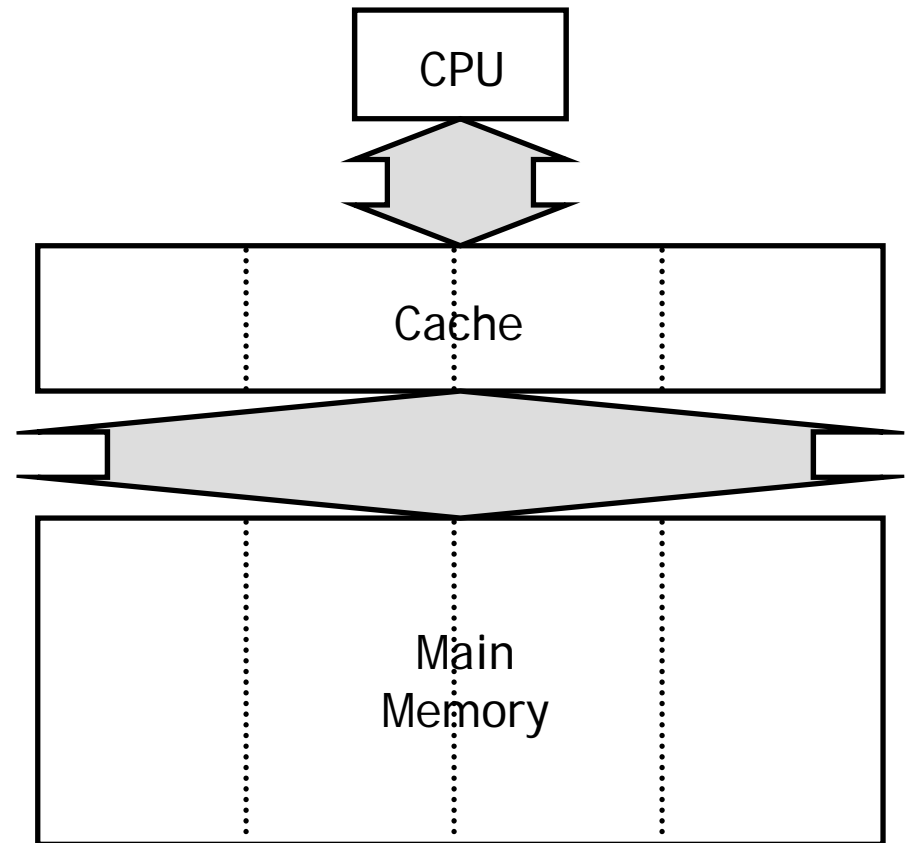

An interleaved memory

- Another approach is to **interleave** the memory, or split it into “banks” that can be accessed individually.
- The main benefit is overlapping the latencies of accessing each word.
- For example, if our main memory has four banks, each one byte wide, then we could load four bytes into a cache block in just 20 cycles.

$$1 + 15 + (4 \times 1) = 20 \text{ cycles}$$

- Our buses are still one byte wide here, so four cycles are needed to transfer data to the caches.
- This is cheaper than implementing a four-byte bus, but not too much slower.

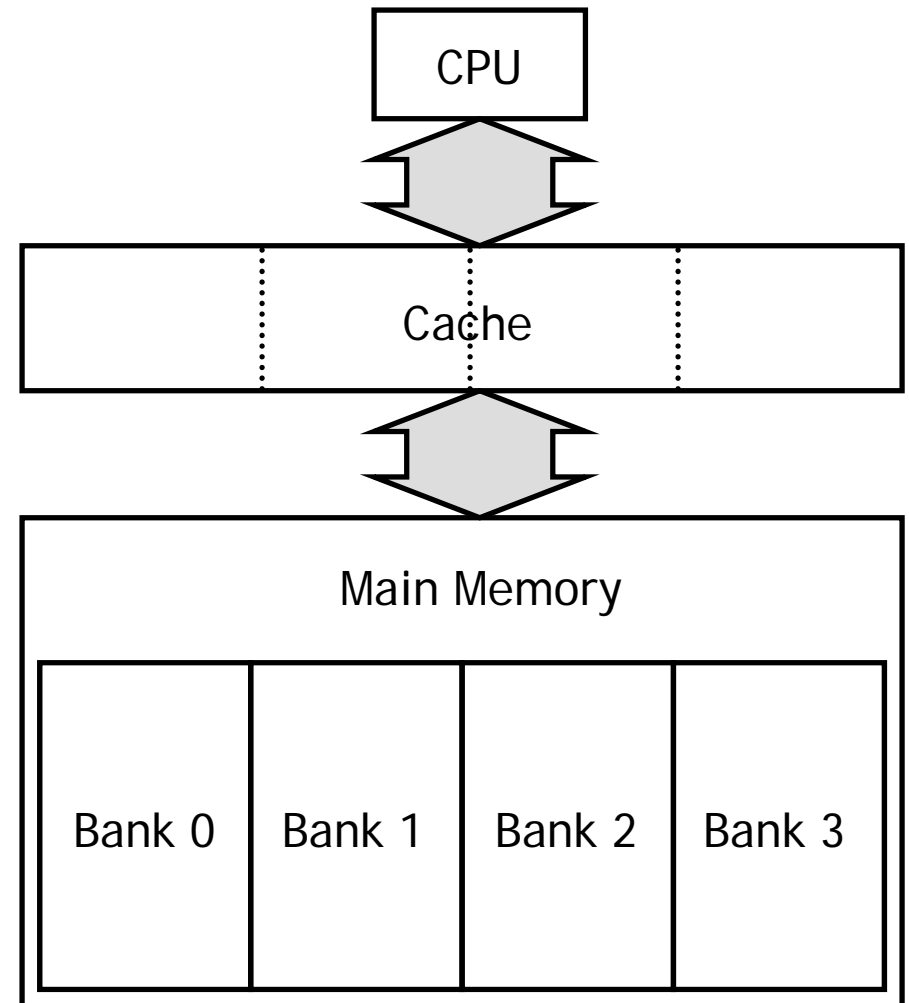

Interleaved memory accesses

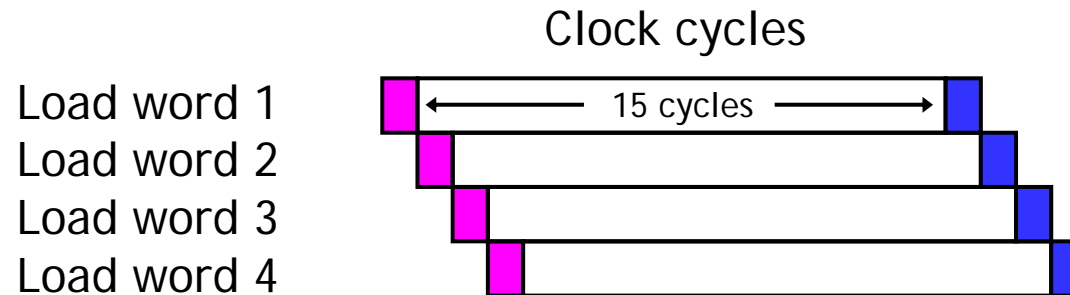

- Here is a diagram to show how the memory accesses can be interleaved.
 - The magenta cycles represent sending an address to a memory bank.
 - Each memory bank has a 15-cycle latency, and it takes another cycle (shown in blue) to return data from the memory.
- This is the same basic idea as pipelining!
 - As soon as we request data from one memory bank, we can go ahead and request data from another bank as well.
 - Each individual load takes 17 clock cycles, but four overlapped loads require just 20 cycles.

Which is better?

- Increasing block size can improve hit rate (due to spatial locality), but transfer time increases. Which cache configuration would be better?

	Cache #1	Cache #2
Block size	32-bytes	64-bytes
Miss rate	5%	4%

- Assume both caches have single cycle hit times. Memory accesses take 15 cycles, and the memory bus is 8-bytes wide:
 - i.e., an 16-byte memory access takes 18 cycles:
1 (send address) + 15 (memory access) + 2 (two 8-byte transfers)

recall: $AMAT = \text{Hit time} + (\text{Miss rate} \times \text{Miss penalty})$

Which is better?

- Increasing block size can improve hit rate (due to spatial locality), but transfer time increases. Which cache configuration would be better?

	Cache #1	Cache #2
Block size	32-bytes	64-bytes
Miss rate	5%	4%

- Assume both caches have single cycle hit times. Memory accesses take 15 cycles, and the memory bus is 8-bytes wide:
 - i.e., an 16-byte memory access takes 18 cycles:
1 (send address) + 15 (memory access) + 2 (two 8-byte transfers)

Cache #1:

$$\text{Miss Penalty} = 1 + 15 + 32\text{B}/8\text{B} = 20 \text{ cycles}$$

$$\text{AMAT} = 1 + (.05 * 20) = 2$$

Cache #2:

$$\text{Miss Penalty} = 1 + 15 + 64\text{B}/8\text{B} = 24 \text{ cycles}$$

$$\text{AMAT} = 1 + (.04 * 24) = \sim 1.96$$

recall: $\text{AMAT} = \text{Hit time} + (\text{Miss rate} \times \text{Miss penalty})$

Summary

- Writing to a cache poses a couple of interesting issues.
 - **Write-through** and **write-back** policies keep the cache consistent with main memory in different ways for write hits.
 - **Write-around** and **allocate-on-write** are two strategies to handle write misses, differing in whether updated data is loaded into the cache.
- Memory system performance depends upon the cache **hit time**, **miss rate** and **miss penalty**, as well as the actual program being executed.
 - We can use these numbers to find the **average memory access time**.
 - We can also revise our CPU time formula to include **stall cycles**.

$$\text{AMAT} = \text{Hit time} + (\text{Miss rate} \times \text{Miss penalty})$$

$$\text{Memory stall cycles} = \text{Memory accesses} \times \text{miss rate} \times \text{miss penalty}$$

$$\text{CPU time} = (\text{CPU execution cycles} + \text{Memory stall cycles}) \times \text{Cycle time}$$

- The organization of a memory system affects its performance.
 - The cache size, block size, and associativity affect the miss rate.
 - We can organize the main memory to help reduce miss penalties. For example, **interleaved memory** supports pipelined data accesses.