

CSE 421

Introduction to Algorithms

Lecture 22: Linear Programming Algorithms

Standard Form LP

Maximize $c^T x$

subject to

$$Ax \leq b$$

$$x \geq 0$$

Algorithms for Linear Programs

Simplex Algorithm

Dantzig 1947

MATH 407

- Simple
- Often fast in practice
- Not polynomial time (on pathological counterexamples)

Ellipsoid Algorithm

Khachin 1976

- More complicated
- First polynomial time algorithm, but not always fast

Interior Point Methods

Karmarkar 1983

— — —

- Even more complicated based on differential equation ideas
- Polynomial time, fast in practice; simplex better for small input size

The Simplex Algorithm

Simplex Algorithm:

- Start with a vertex of the polytope
- In each step move to a neighboring vertex that is *lower* (larger $c^T x$).

Creates a path running along the edges and vertices on the outside of the polytope

- Since the polytope is convex, this will never get stuck before reaching the lowest point.

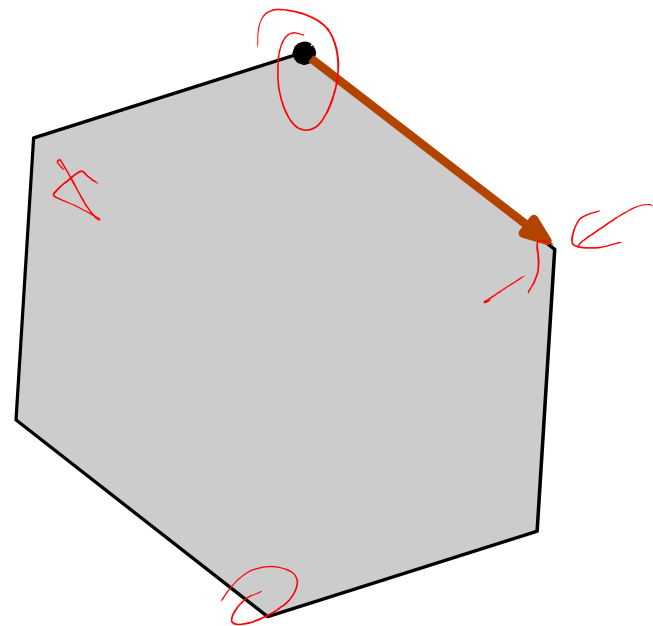

Polytope given by $Ax \leq b$

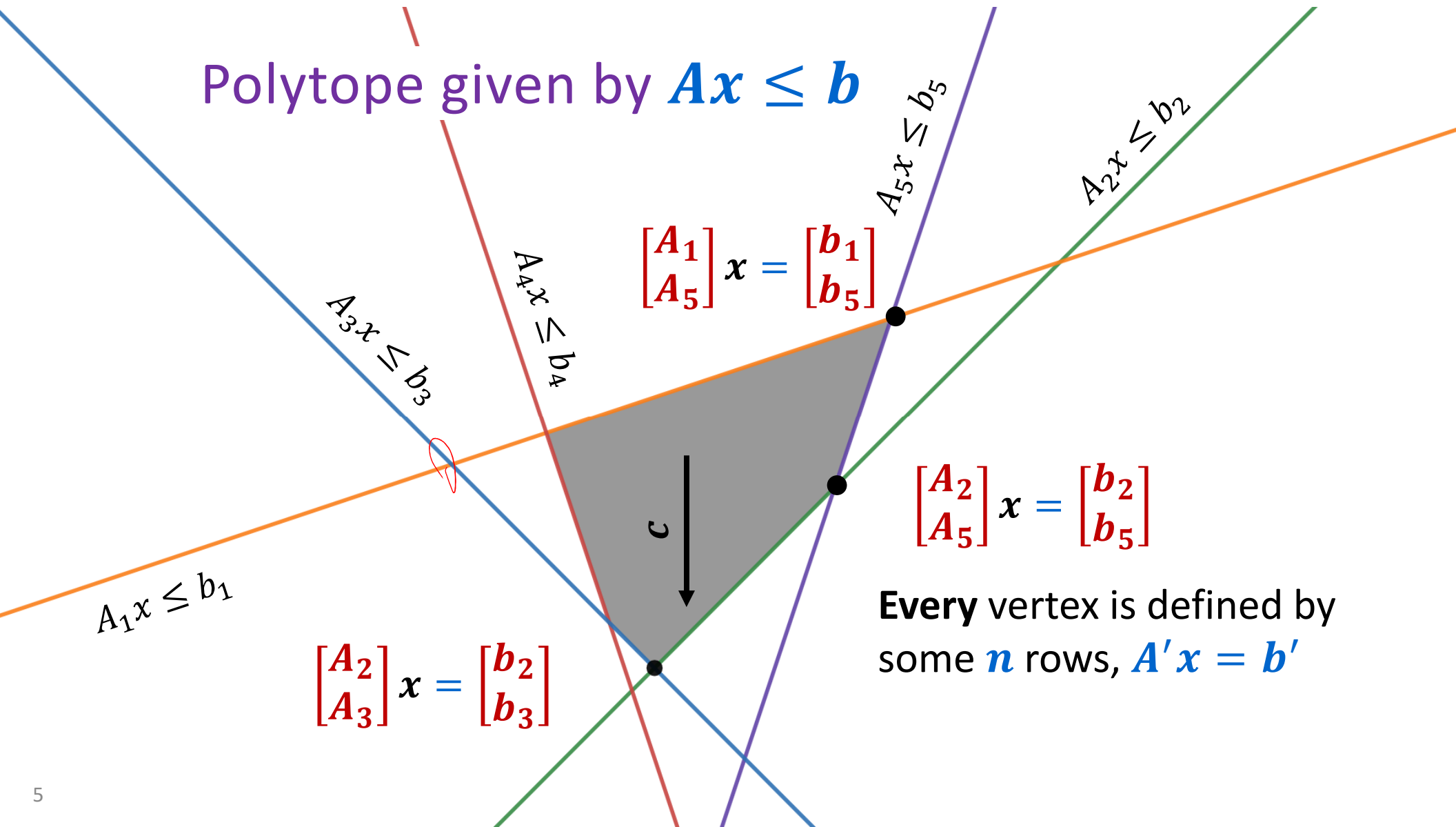

Every vertex is defined by some n rows, $A'x = b'$

Simplex: How to find the start vertex

We can't just choose any subset of n equations since their solution might not be in the polytope P ...

Given

Maximize $c^T x$

subject to

$$Ax \leq b$$

$$x \geq 0$$

Solve P

Find point s.t.

$$Ax \leq b$$

$$x \geq 0$$

Solve Q

Minimize $z_1 + \dots + z_m$

subject to

$$Ax - z \leq b$$

$$x, z \geq 0$$

$x \in P$  $(x, z) \in Q$

\Rightarrow

\Leftrightarrow

Polytope P is not empty iff minimum for Q has $z = 0$ and $x \in P$

Q is just another LP, but we set it up so we know a start vertex:

$-z \leq b$
need $z \geq -b$

$$x = 0 \text{ and } z = \max(0, -b)$$

so we can use Simplex on Q to find the start vertex for the given LP and then run Simplex again!

The Simplex Algorithm

Simplex Algorithm:

- Start with a vertex of the polytope
- In each step move to a neighboring vertex that is *lower* (larger $c^T x$).

Creates a path running along the edges and vertices on the outside of the polytope

- Since the polytope is convex, this will never get stuck before reaching the lowest point.

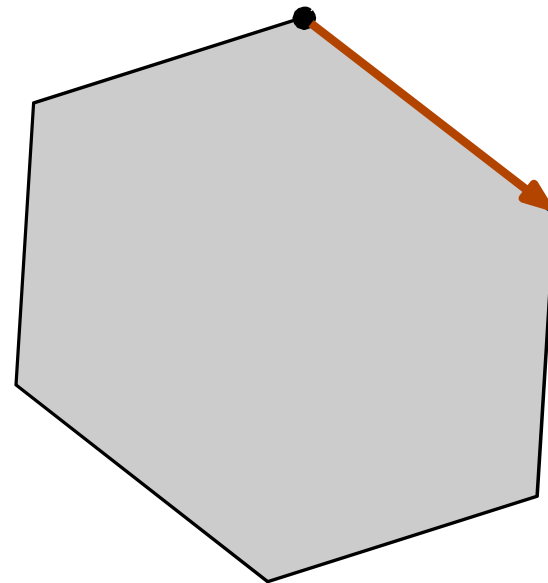

Polytope given by $Ax \leq b$

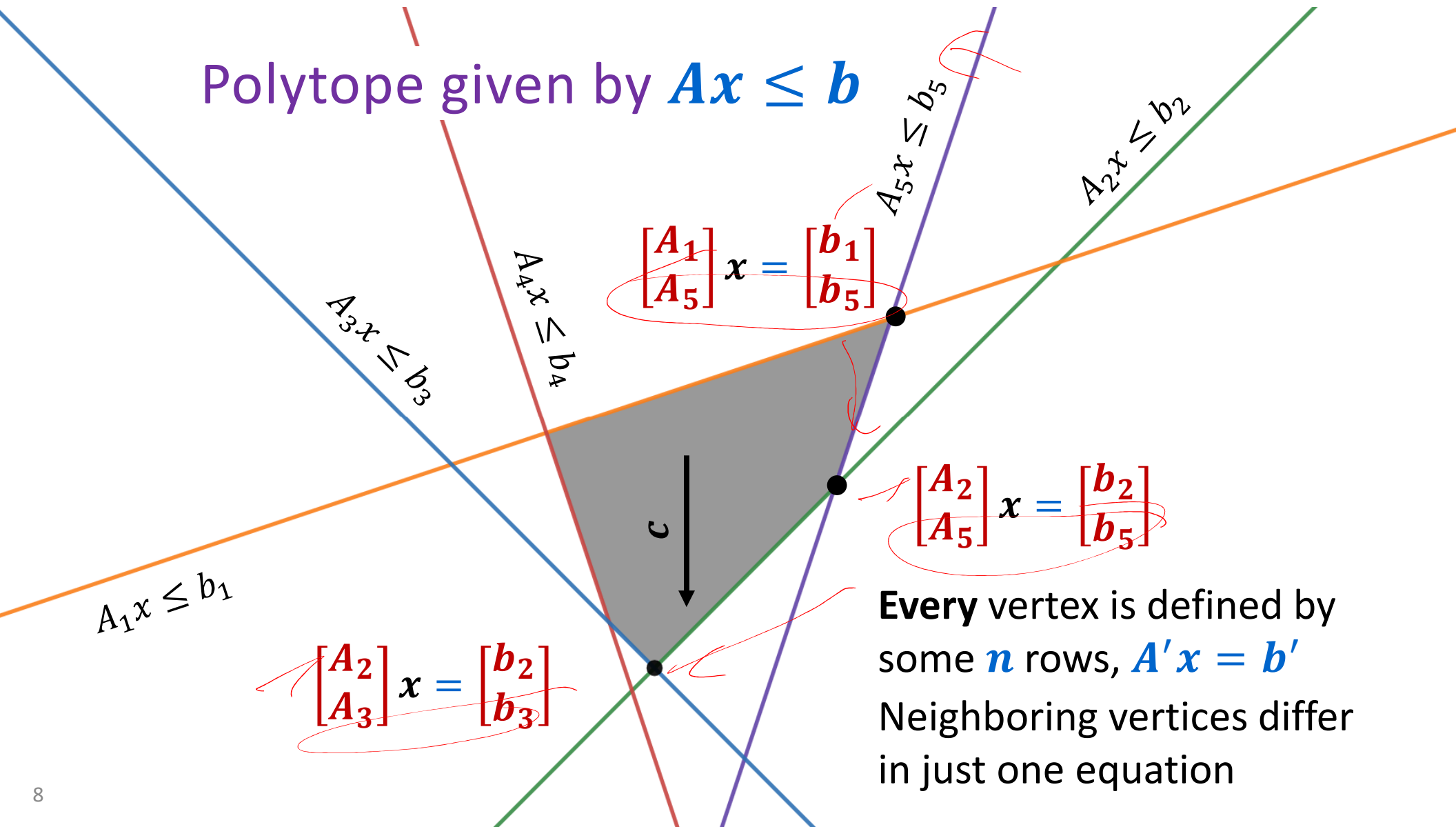

$$\begin{bmatrix} A_1 \\ A_5 \end{bmatrix} x = \begin{bmatrix} b_1 \\ b_5 \end{bmatrix}$$

$$\begin{bmatrix} A_2 \\ A_5 \end{bmatrix} x = \begin{bmatrix} b_2 \\ b_5 \end{bmatrix}$$

$$\begin{bmatrix} A_2 \\ A_3 \end{bmatrix} x = \begin{bmatrix} b_2 \\ b_3 \end{bmatrix}$$

Every vertex is defined by some n rows, $A'x = b'$
Neighboring vertices differ in just one equation

Simplex: Moving to a better vertex

Maximize $c^T x$

subject to

$$Ax \leq b$$

$$x \geq 0$$

1. At current vertex have n tight equations $A'x = b'$
2. Can find 1 equation to replace and y
 - satisfying the other $n - 1$
 - with $c^T y > 0$.
3. Move to new vertex of form $x' = x + \delta y \in P$ for $\delta > 0$
 - Increase δ until some new constraint becomes tight.

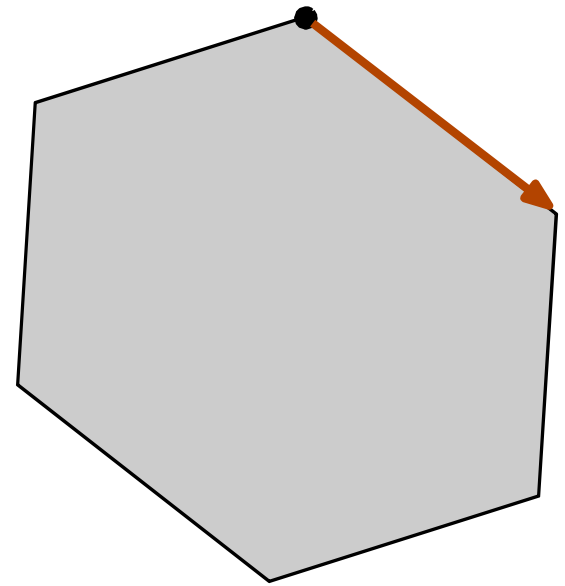

$$c^T x' = c^T x + c^T \delta y$$

> 0

The Simplex Algorithm: The downside

Simplex Algorithm:

- Start with a vertex of the polytope
- In each step move to a neighboring vertex that is *lower* (larger $c^T x$).

Creates a path running along the edges and vertices on the outside of the polytope

- Since the polytope is convex, this will never get stuck before reaching the lowest point.

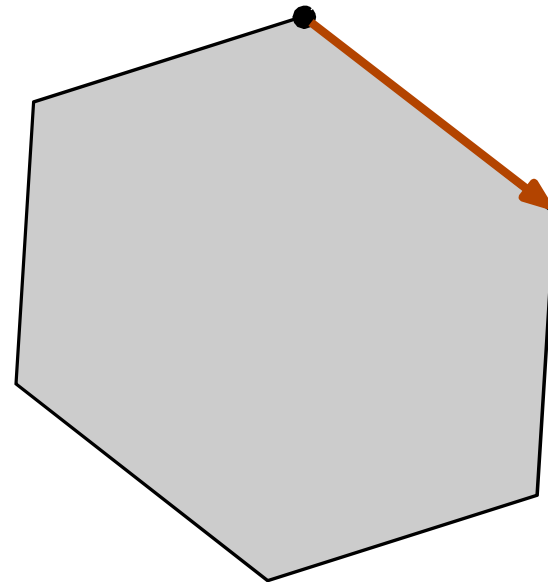

Problem: Many paths to choose from; # of vertices on path can be exponential!

Interior Point Algorithms

Interior Point Idea:

- Start with a point in the polytope, either a vertex or in the interior
- Follow approximations to a curving “central path” that
 - tunnels through the polytope
 - avoids the boundary using loss functions and eventually gets to the optimum

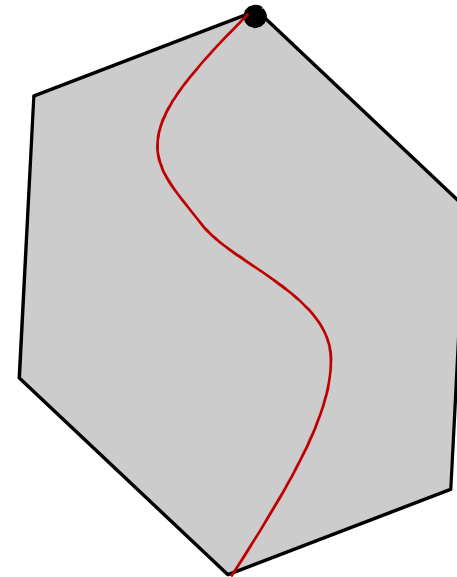

Can be implemented efficiently using data structure tricks. Also leads to best randomized algorithms for network flow. Too complicated for us.

Ellipsoid Method

Ellipsoid:

- A squished ball

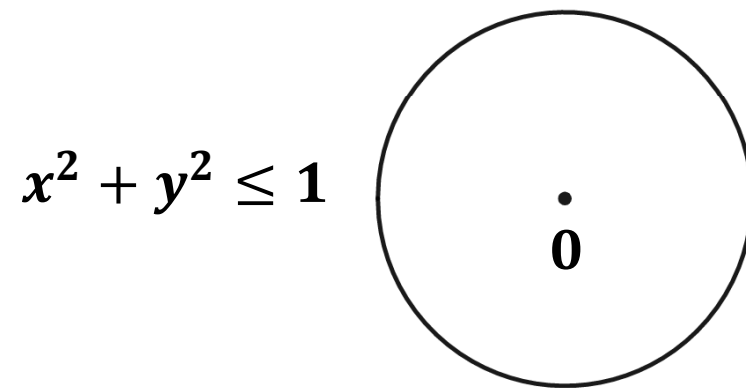

Ellipsoid Method

Ellipsoid:

- A squished ball

$$x^2 + y^2 \leq 1$$

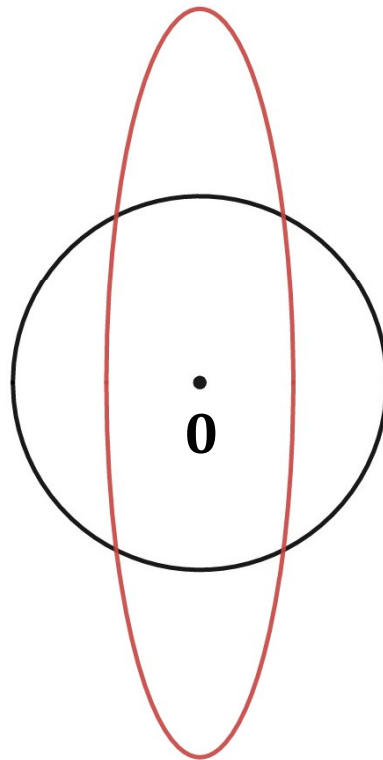

$$(2x)^2 + (y/2)^2 \leq 1$$

Ratio of area of ellipsoid
to the sphere

$$\frac{2}{1} \cdot \frac{1}{2} = 1$$

Ellipsoid Method

Ellipsoid:

- A squished ball

$$x^2 + y^2 \leq 1$$

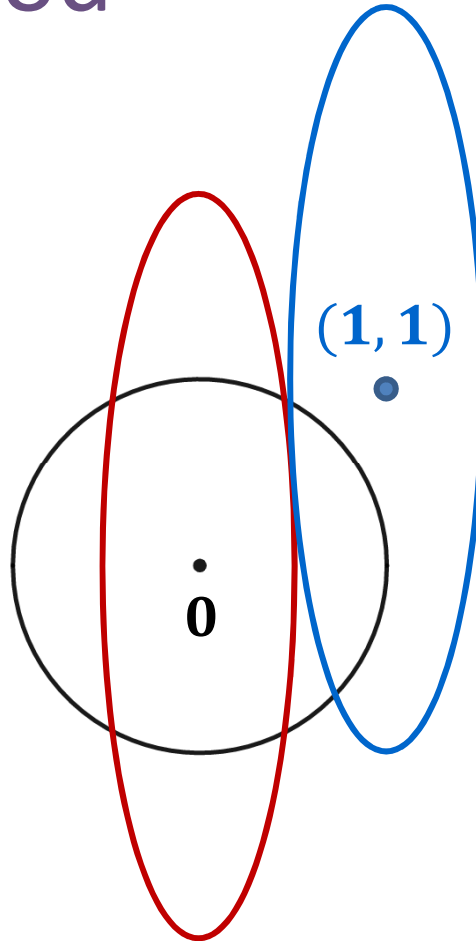

$$(2x)^2 + (y/2)^2 \leq 1$$

Can shift the center

$$2(x - 1)^2 + ((y - 1)/2)^2 \leq 1$$

Ratio of area of ellipsoid
to the sphere

$$\frac{2}{1} \cdot \frac{1}{2} = 1$$

Ellipsoid Method

Ellipsoid:

- A squished ball

Let U^{-1} be the inverse of a rotation

$$2(U_1(x-1))^2 + (U_2(y-1)/2)^2 \leq 1$$

$$(U_1x)^2 + (U_2x)^2 \leq 1$$

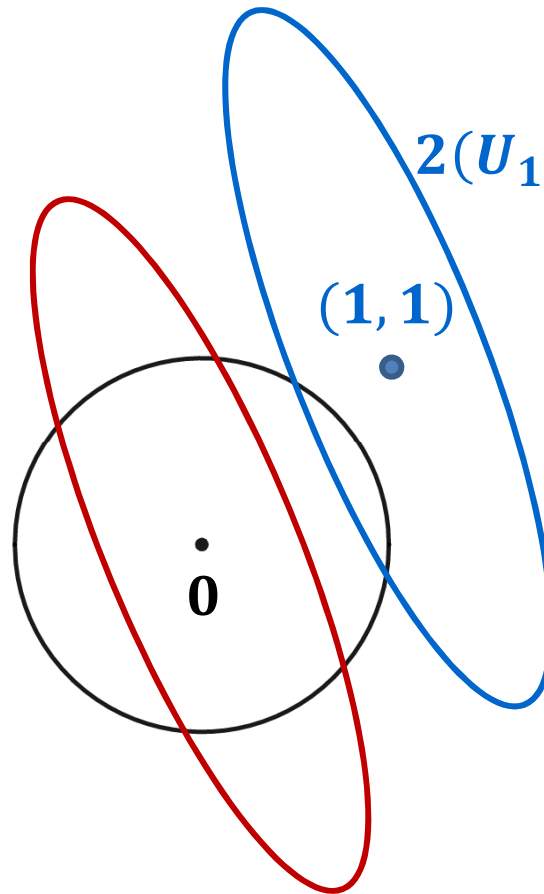

Ratio of area of ellipsoid
to the sphere

$$\frac{2}{1} \cdot \frac{1}{2} = 1$$

$$(2U_1x)^2 + (U_2y/2)^2 \leq 1$$

The desired solution is bounded

Theorem: If the LP solution is finite then its magnitude is at most $2^{\text{poly}(\text{input length})}$.

Proof: If the optimum is finite then the solution occurs at a vertex which is the solution of some $A'x = b'$, equivalently $x = (A')^{-1}b'$. The matrix inverse has coordinates with at most # of input bits.

Theorem: If the LP optimum is ~~finite~~ then the volume of the polytope is at least $2^{-\text{poly}(\text{input length})}$.

Proof: General idea: The smallest angle is at least $2^{-\text{poly}(\text{input length})}$.

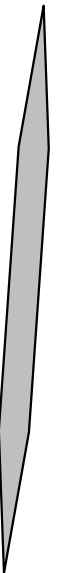

Ellipsoid Method

Reduce solving:

Maximize $c^T x$

subject to

$$Ax \leq b$$

$$x \geq 0$$

To solving:

Is there an x s.t.

$$c^T x \geq d$$

$$Ax \leq b$$

$$x \geq 0?$$

Theorem: If the LP solution is finite then its magnitude is at most $2^{\text{poly}(\text{input length})}$.

Corollary: In polytime we can compute $T \in 2^{\text{poly}(\text{input length})}$ such that if the LP optimum x is finite then $-T \leq c^T x \leq T$.

Claim: If we have a polynomial time algorithm to find point x inside polytopes then we can solve LPs in polynomial time using binary search with different values of d as above. (Only $\text{poly}(\text{input length})$ calls.)

Using binary search

~~$y = T$~~
 $y = T$

$y = c^T x$



$y = -T$

Check if polytope is empty

$$y = T$$



$$y = -T$$

Add new constraint

$$y = T$$

$$y \leq 0$$

$$y = -T$$



Find point

$$y = T$$

$$y \leq 0$$

$$y = -T$$



Add new constraint

$$y \leq 0$$

$$y \leq -T/2$$

$$y = -T$$



Find point: Polytope is empty!

$$y \leq 0$$

$$y \leq -T/2$$

$$y = -T$$



Add new constraint

$$y \leq 0$$

$$y \leq -T/4$$

$$y \leq -T/2$$



Add new constraint

$$y \leq 0$$

$$y \leq -T/4$$

$$y \leq -T/2$$

Find point

$$y \leq 0$$

$$y \leq -T/4$$

$$y \leq -T/2$$



Add new constraint

$$y \leq -T/4$$

$$y \leq -3T/8$$

$$y \leq -T/2$$

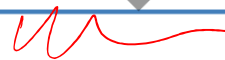

Find point: Polytope is empty!

$$y \leq -T/4$$

$$y \leq -3T/8$$

$$y \leq -T/2$$

Add new constraint... Find point ...

$$y \leq -5T/16$$
$$y \leq -T/4$$
$$y \leq -3T/8$$



Conclusion: It is enough to give an algorithm to find a point in a polytope.

Ellipsoid algorithm for finding points in polytopes

Idea: Iteratively find ellipsoids where the density of the polytope within each ellipsoid is larger and larger, until a point is found

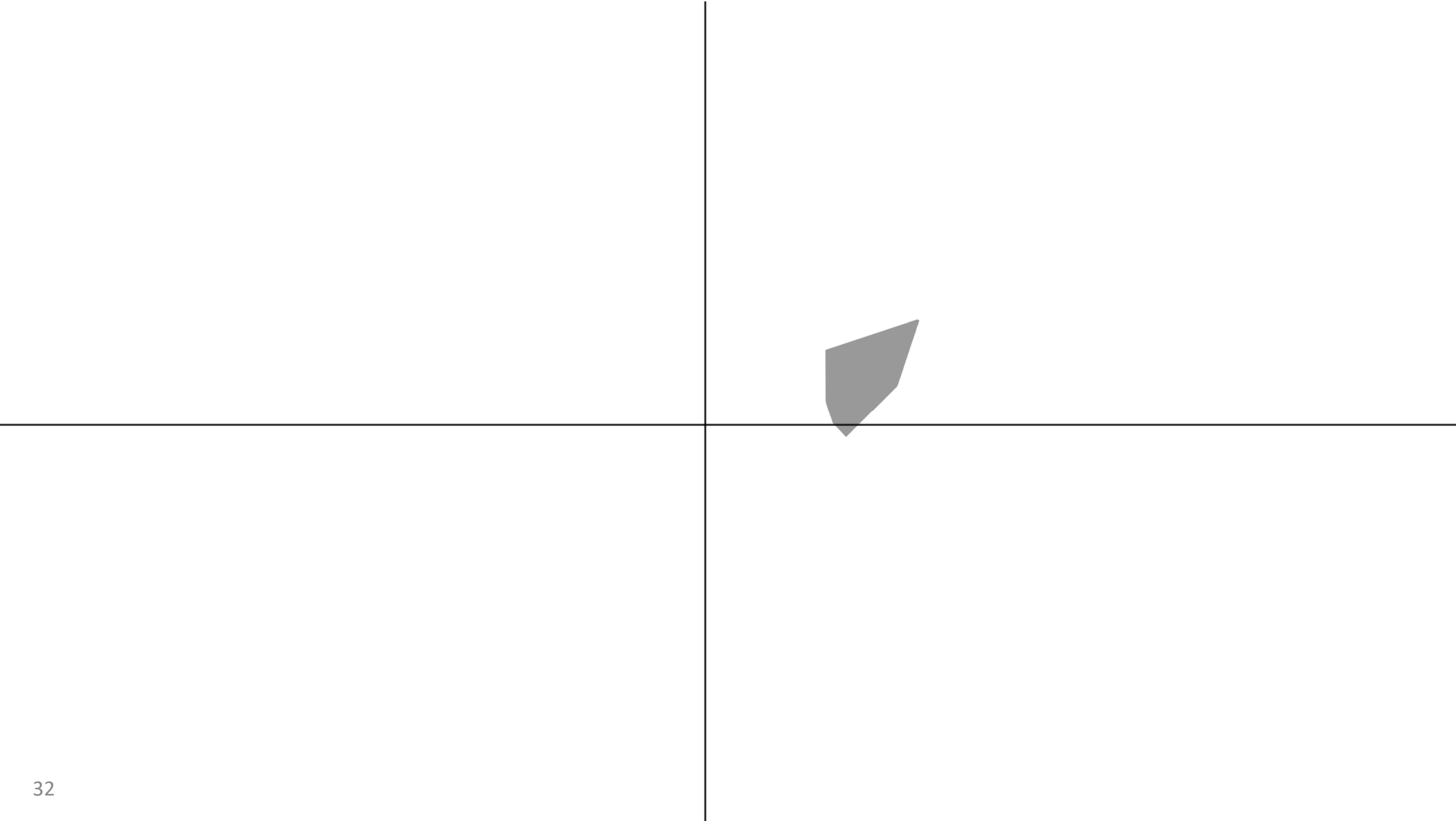

Theorem: If the polytope is finite then its points have magnitude at most

$$R = 2^{poly(\text{input length})}.$$

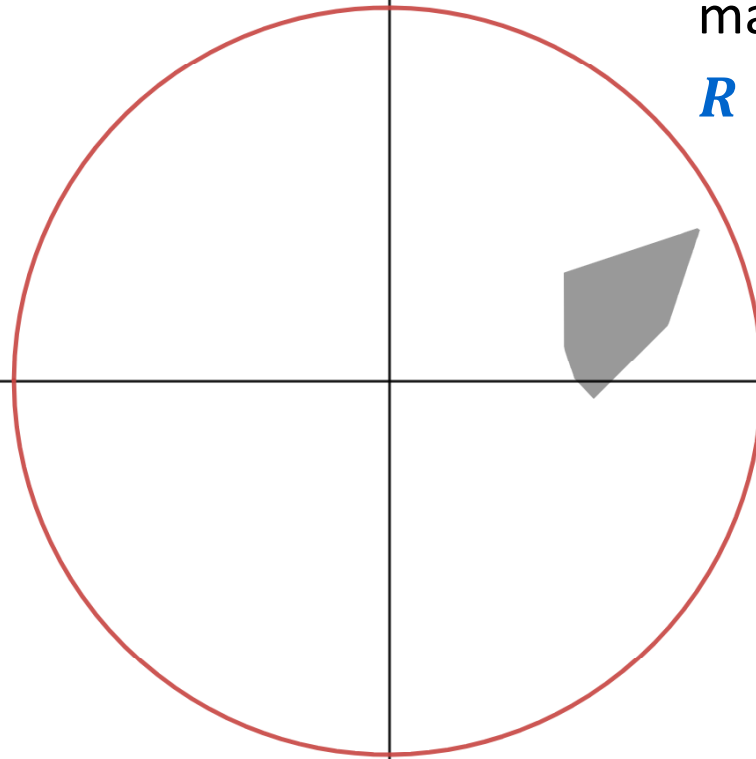

Begin with sphere of radius

$$R = 2^{poly(\text{input length})}.$$

containing solution

Check **0**

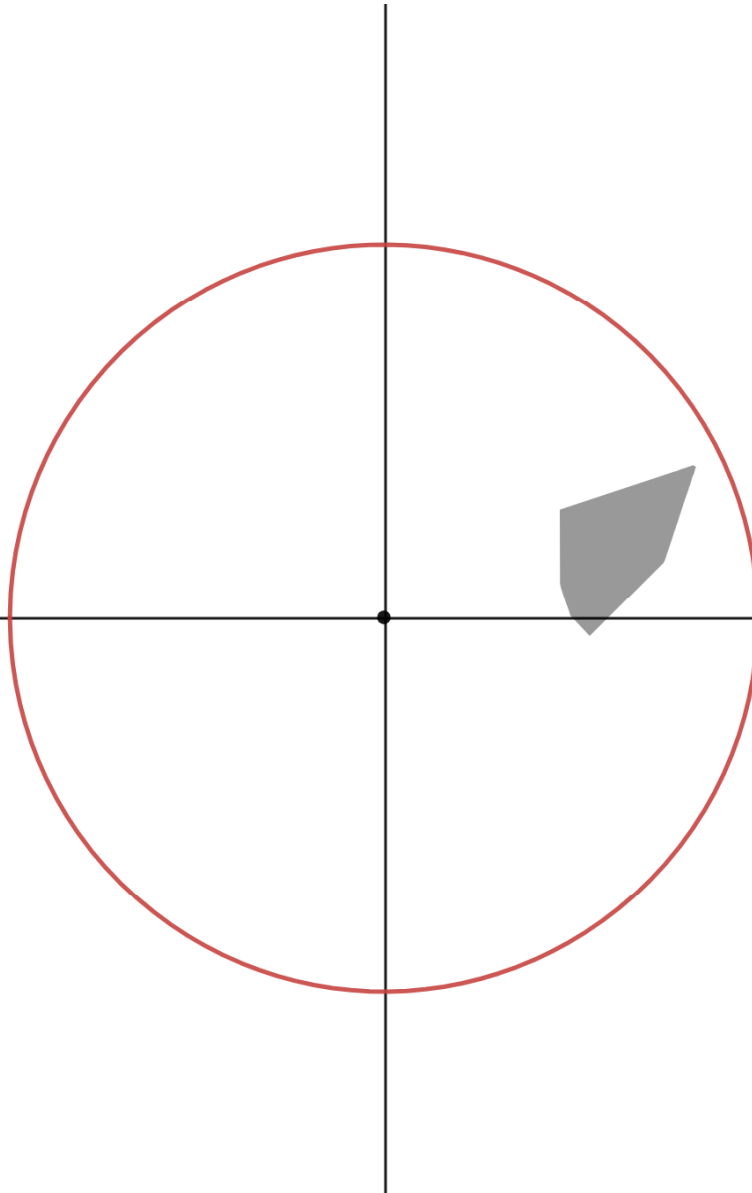

Find violated inequality

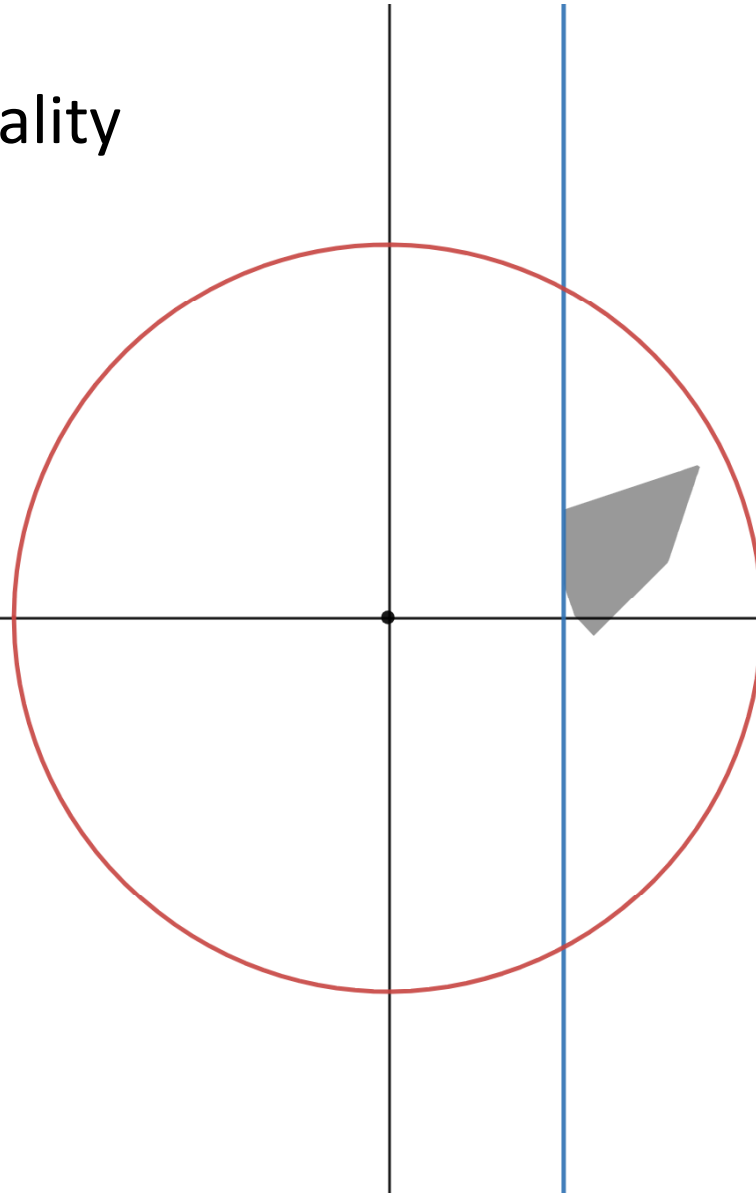

Shift inequality to origin

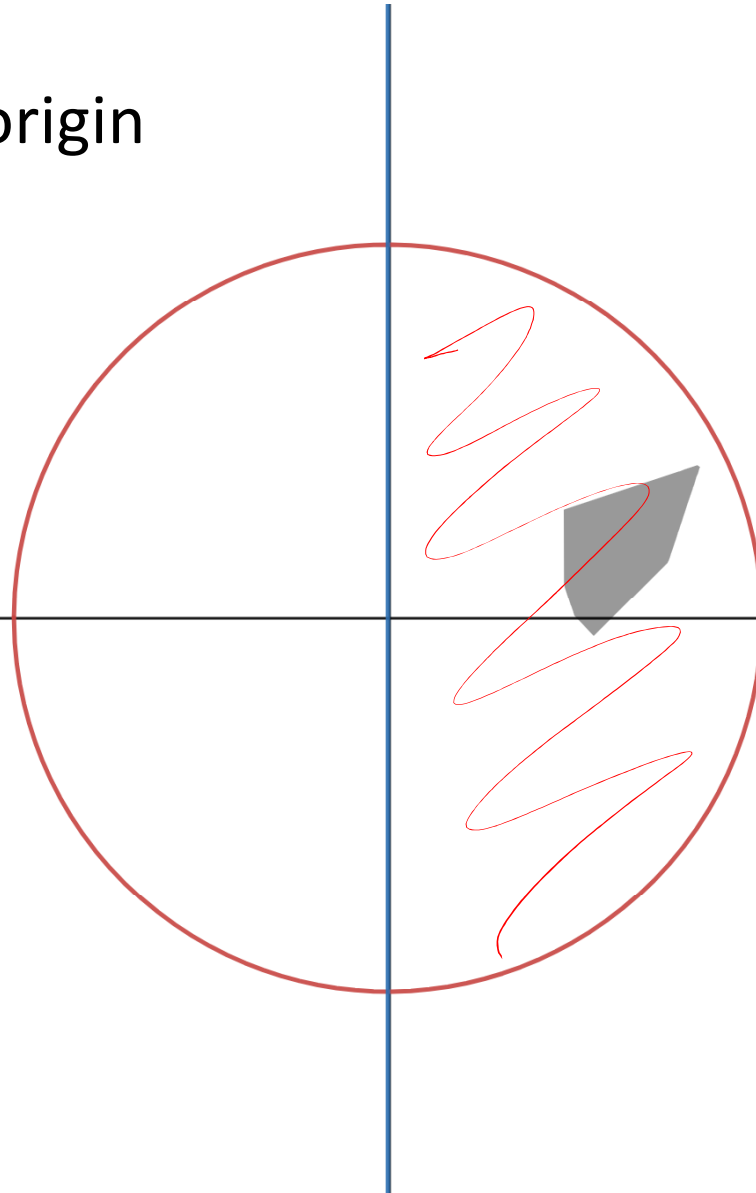

Find ellipsoid containing
half-sphere

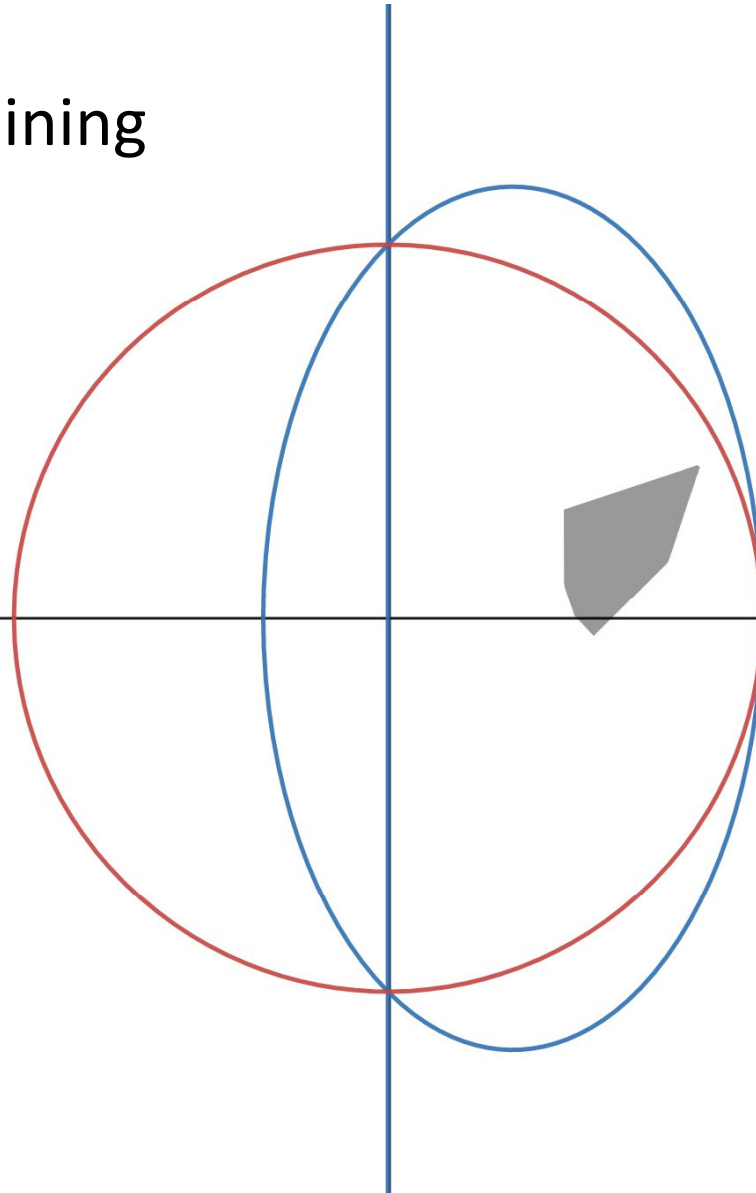

Find ellipsoid containing
half-sphere

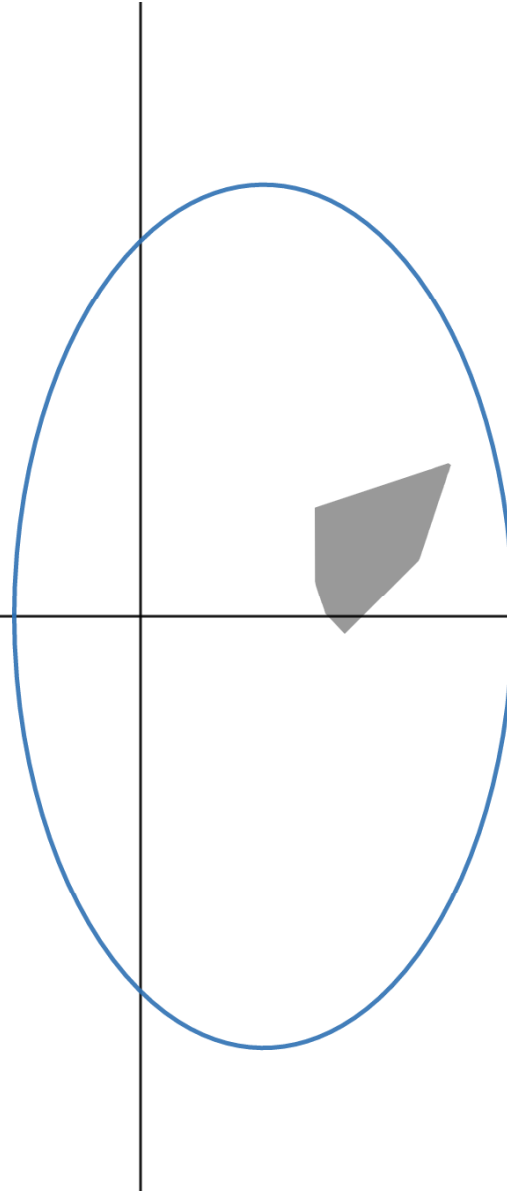

Shift to center

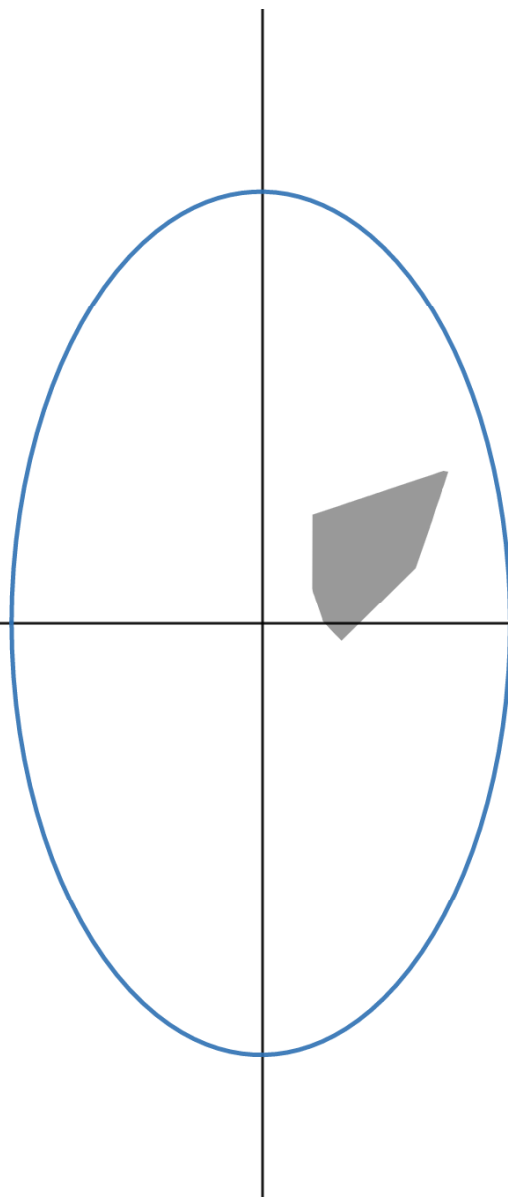

Stretch to get sphere

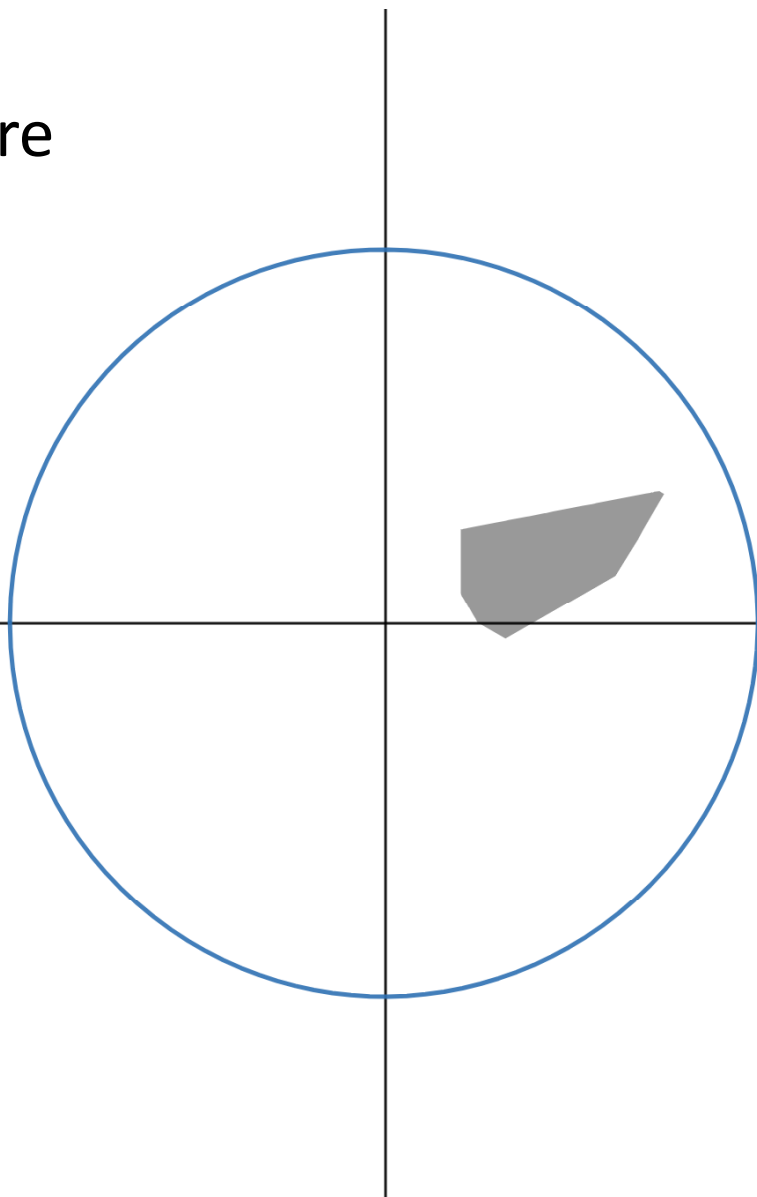

Check **0**

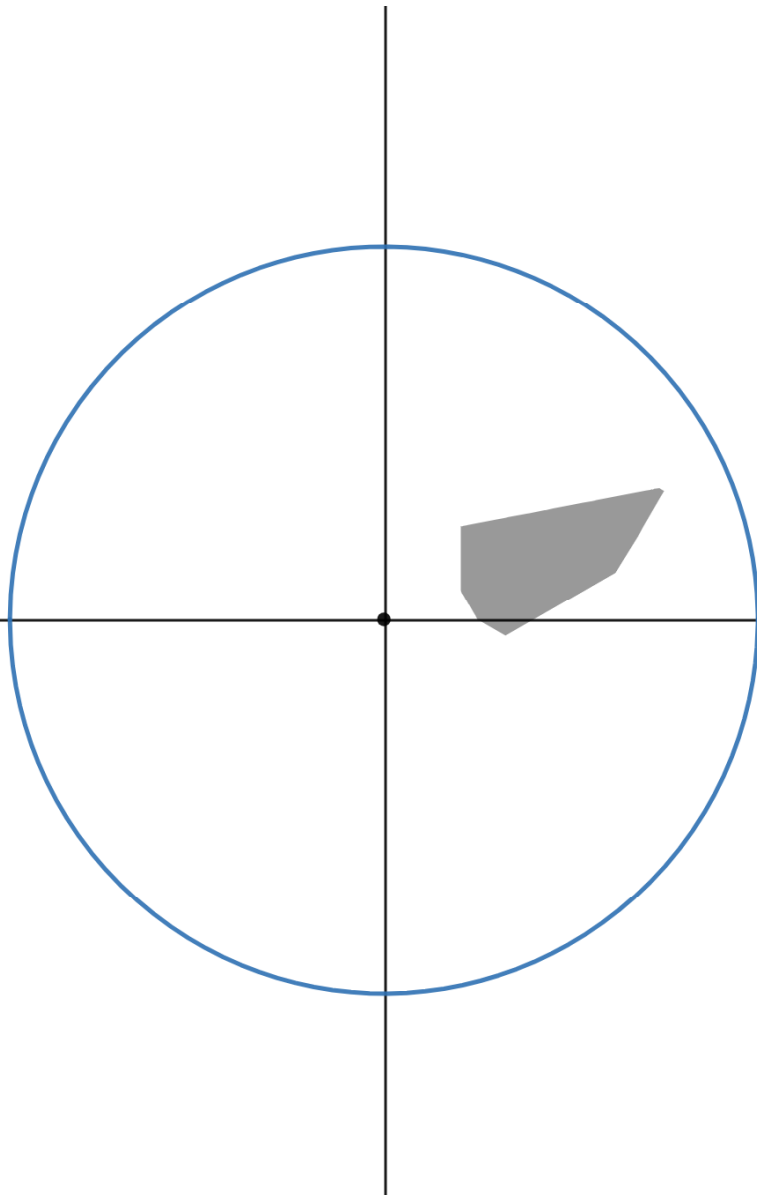

Find violated inequality

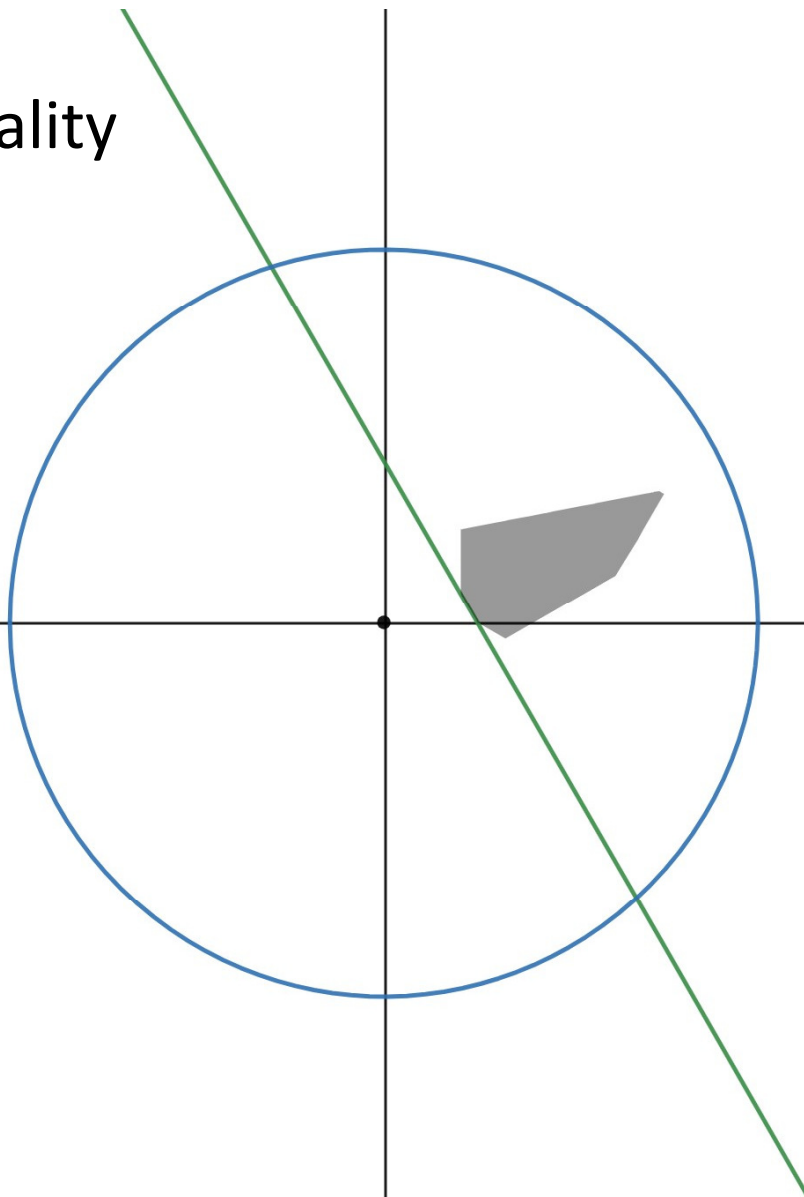

Shift inequality to origin

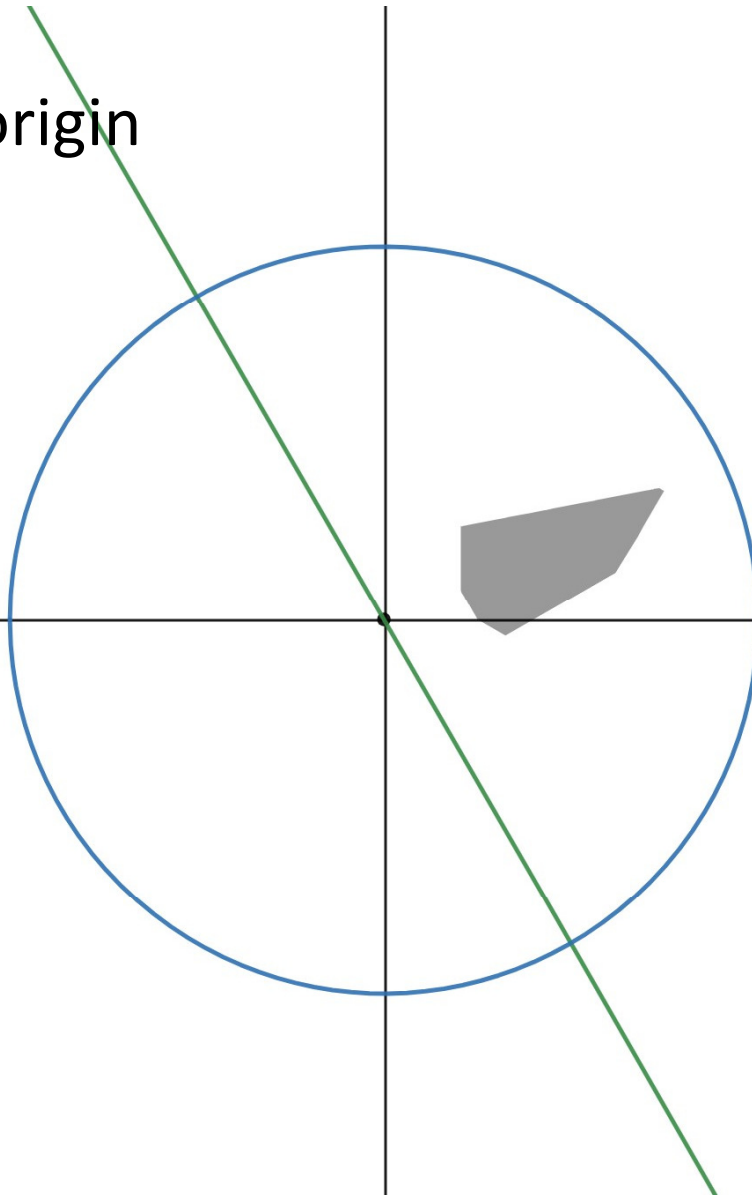

Find ellipsoid containing
half-sphere

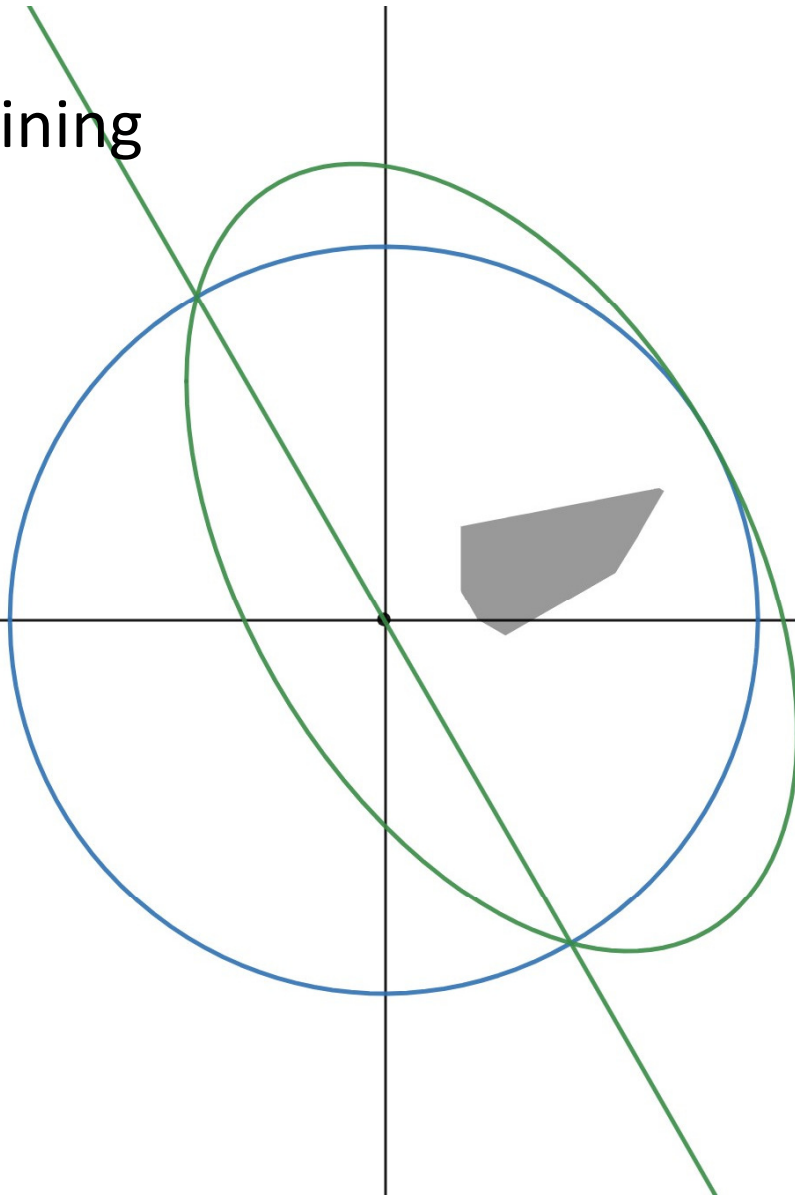

Find ellipsoid containing
half-sphere

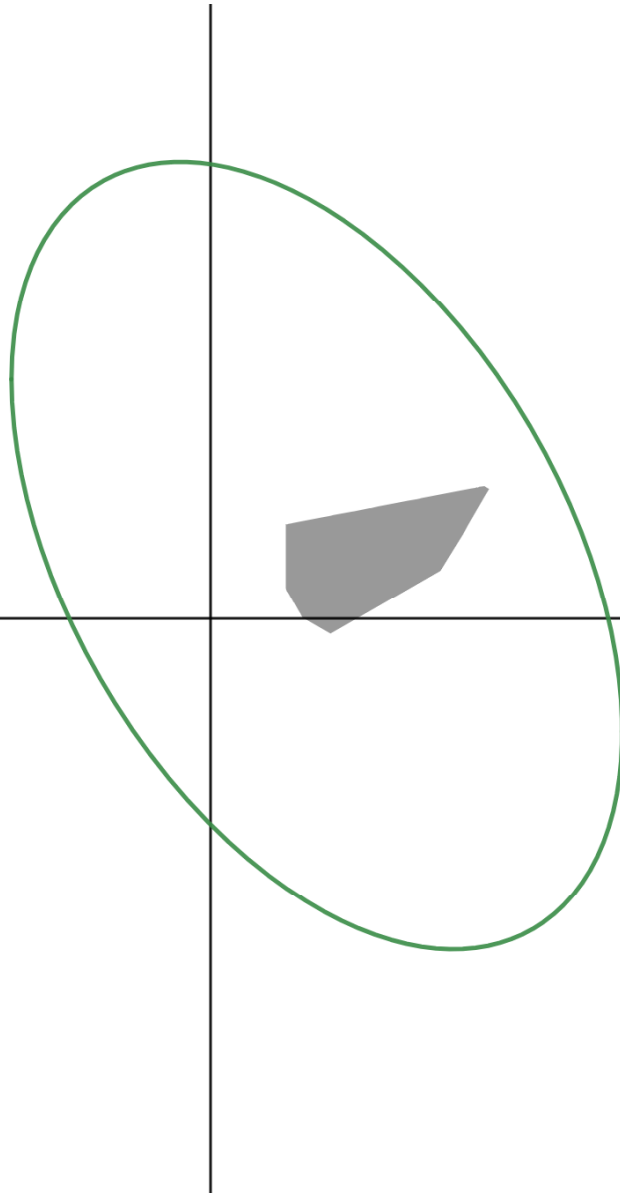

Shift to center

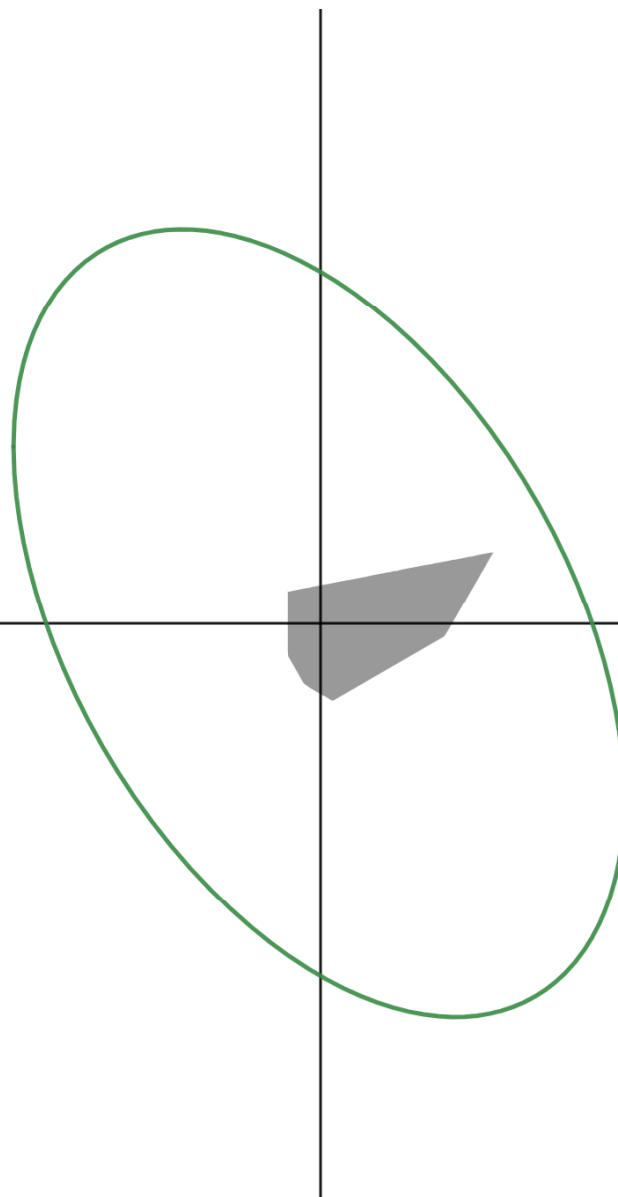

Stretch to get sphere

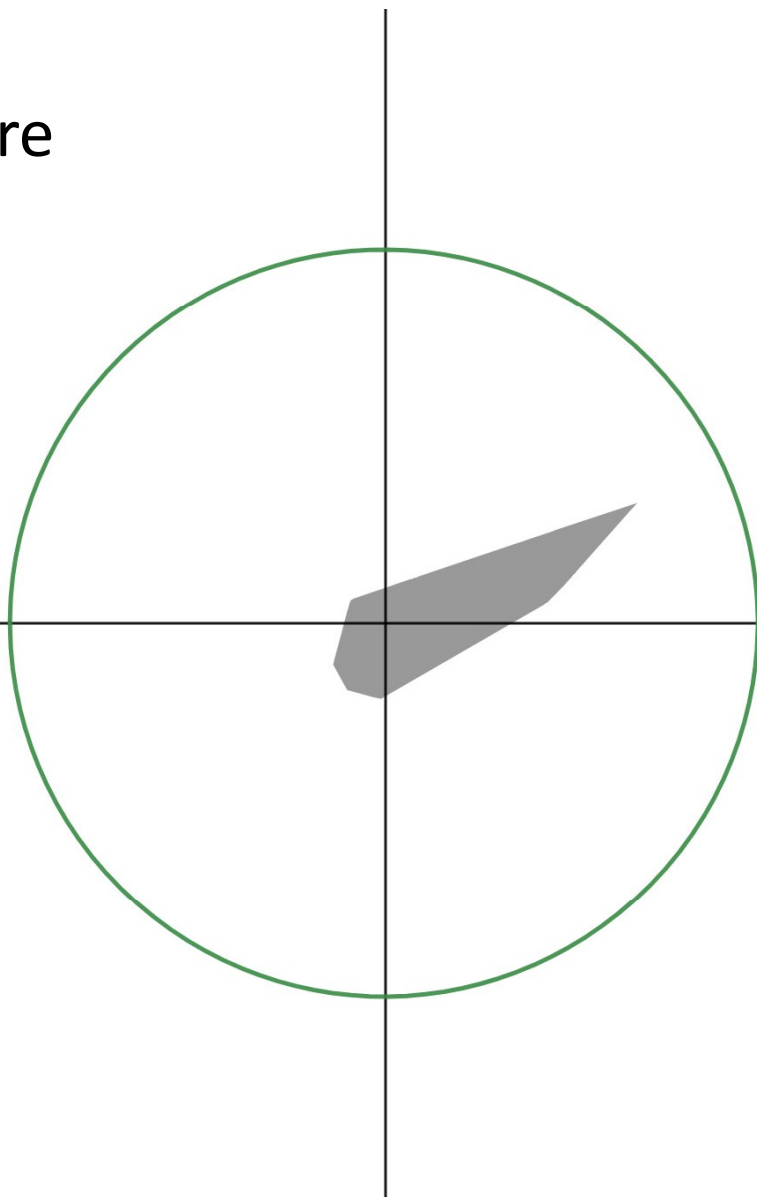

Check **0**

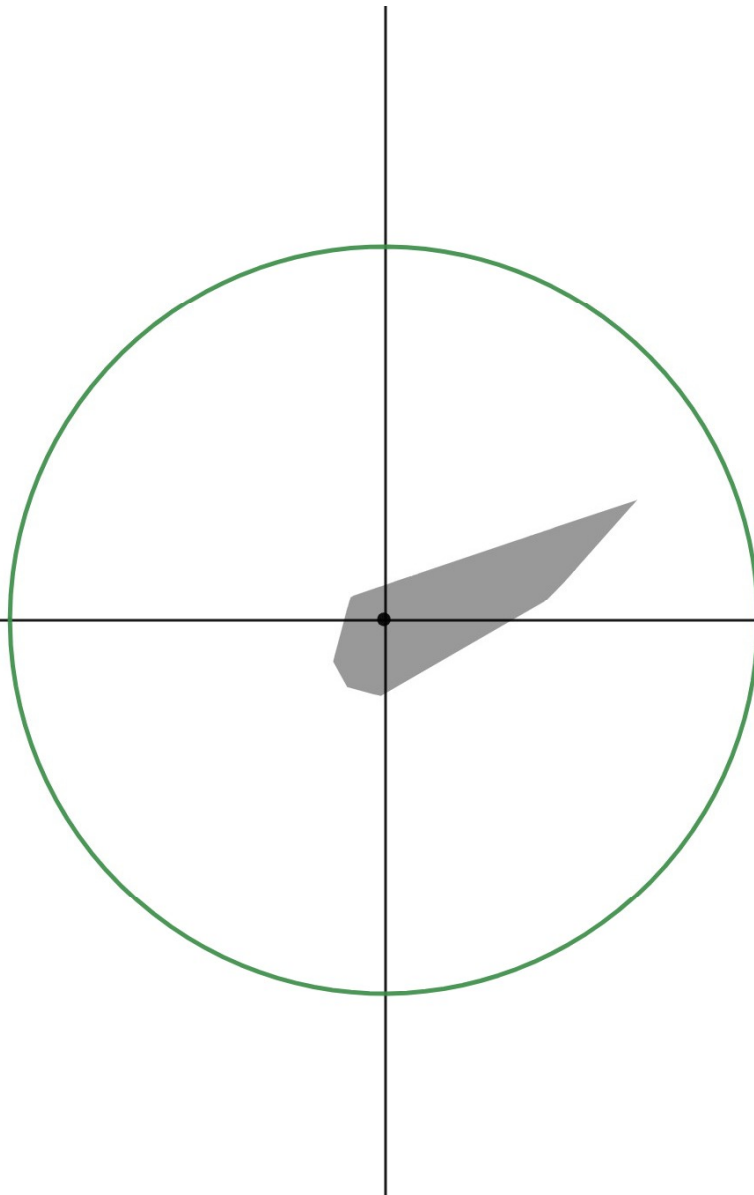

Ellipsoid Method

Is there an x s.t.

$$c^\top x \geq d$$

$$Ax \leq b$$

$$x \geq \mathbf{0} ?$$

Algorithm to find a point in a non-empty bounded polytope P :

1. Compute ellipsoid E as a radius R sphere containing polytope P
2. If $\mathbf{0} \in P$, output original equivalent point
 - a. Otherwise identify violated constraint for $\mathbf{0}$, shift to origin to identify half-sphere inside E
 - b. Let E' be ellipsoid containing half-sphere
 - c. Shift and rescale E' to sphere E , applying the same to P and begin step 2.

Key Lemma:

$$\text{vol}(E')/\text{vol}(E) \leq e^{-1/(2n+1)}$$

Corollary:

$$\frac{\text{vol}(P)}{\text{vol}(E')} \geq e^{1/(2n+1)} \frac{\text{vol}(P)}{\text{vol}(E)}$$

Thm: After t rounds

$$\frac{\text{vol}(P)}{\text{vol}(E_t)} \geq e^{t/(2n+1)} \frac{\text{vol}(P)}{\text{vol}(E)}$$

Cor: Ellipsoid algorithm

halts after

$\text{poly}(\text{input length})$ steps

Key Lemma part 1

Define E by $\sum_i x_i^2 \leq 1$

Let E' be given by $\left(\frac{n+1}{n}\right)^2 \left(x_1 - \frac{1}{n+1}\right)^2 + \left(1 - \frac{1}{n^2}\right) \sum_{i \geq 2} x_i^2 \leq 1$.

Claim: E' contains the positive half-sphere.

Proof: Note that $(1, 0, \dots, 0) \in E'$ since $\left(\frac{n+1}{n}\right)^2 \left(1 - \frac{1}{n+1}\right)^2 = 1$.

Consider intersection of E with $x_1 = 0$: $(0, x_2, \dots, x_n)$ with $\sum_{i \geq 2} x_i^2 \leq 1$

LHS for E' for these points: $\leq \left(\frac{n+1}{n}\right)^2 \left(-\frac{1}{n+1}\right)^2 + \left(1 - \frac{1}{n^2}\right) = \frac{1}{n^2} + 1 - \frac{1}{n^2} = 1$

so these points are all in E' .

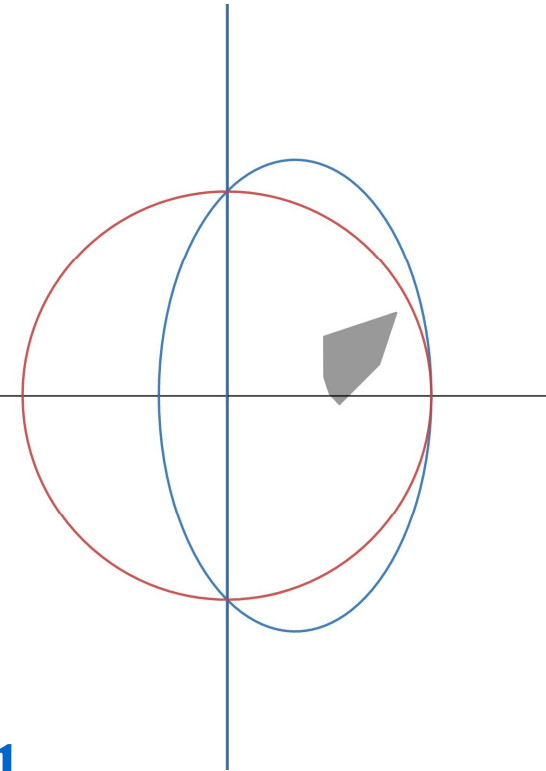

Key Lemma part 2

Define E by $\sum_i x_i^2 \leq 1$

Let E' be given by $\underbrace{\left(\frac{n+1}{n}\right)^2}_{\text{red underline}} \underbrace{\left(x_1 - \frac{1}{n+1}\right)^2}_{\text{red underline}} + \underbrace{\left(1 - \frac{1}{n^2}\right)}_{\text{red underline}} \sum_{i \geq 2} x_i^2 \leq 1$.

Claim: $\text{vol}(E')/\text{vol}(E) \leq e^{-1/(2n+1)}$

Proof: First coordinate scales down by an $\left(\frac{n}{n+1}\right)$ factor. Each of the other $n-1$ coordinates scales up by a $\left(\frac{n^2}{n^2-1}\right)^{1/2}$ factor. Volume scales by $\left(\frac{n}{n+1}\right) \left(\frac{n^2}{n^2-1}\right)^{(n-1)/2}$

This is $\left(1 - \frac{1}{n+1}\right) \left(1 + \frac{1}{n^2-1}\right)^{(n-1)/2} \leq e^{-\frac{1}{n+1}} e^{\frac{1}{2(n+1)}} = e^{\frac{-1}{2(n+1)}}$ using $1+z \leq e^z$.

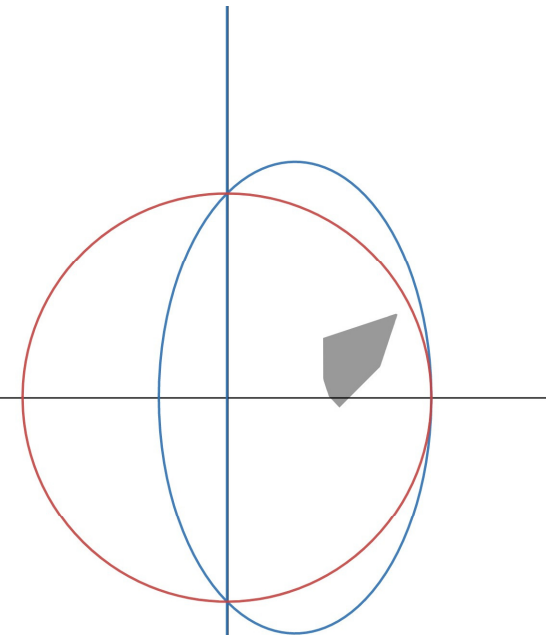

Why is linear programming so powerful?

In a sense, every polynomial-time algorithm can be expressed as polynomial-size linear program!

Idea: For any Boolean logic circuit can define an LP with one variable per input and one variable per gate to compute its output.

Why is linear programming so powerful?

Idea: For any Boolean logic circuit can define an LP with one variable per input and one variable per gate to compute its output.

NOT gate

$$h = \neg g$$

$$g + h = 1$$

OR gate

$$h = f \vee g$$

$$h \geq f$$

$$h \geq g$$

$$h \leq f + g$$

$$h \leq 1$$

AND gate

$$h = f \wedge g$$

$$h \leq f$$

$$h \leq g$$

$$h \geq f + g - 1$$

$$h \geq 0$$