

RNA Search and Motif Discovery

CSE 427
Computational Biology

Previous Lecture

Many biologically interesting roles for RNA
RNA secondary structure prediction

Approaches to Structure Prediction

Maximum Pairing

- + works on single sequences
- + simple
- too inaccurate

Minimum Energy

- + works on single sequences
- ignores pseudoknots
- only finds “optimal” fold

Partition Function

- + finds all folds
- ignores pseudoknots

“Optimal pairing of $r_i \dots r_j$ ”

Two possibilities

j Unpaired:

Find best pairing of $r_i \dots r_{j-1}$

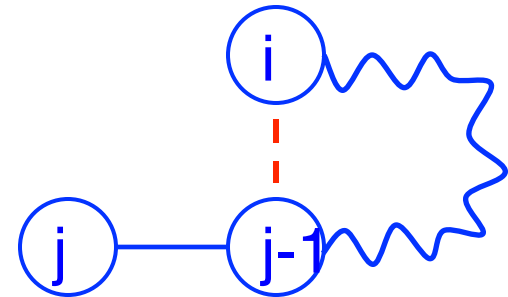

j Paired (with some k):

Find best $r_i \dots r_{k-1}$ +

best $r_{k+1} \dots r_{j-1}$ **plus 1**

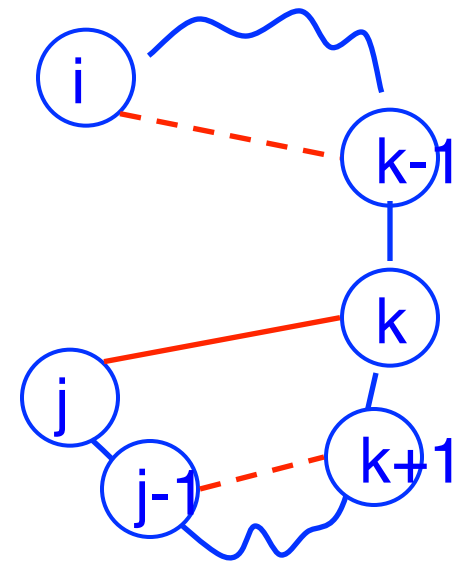

Why is it slow?

Why do pseudoknots matter?

Computation Order

$B(i,j) = \# \text{ pairs}$ Or energy in optimal pairing of $r_i \dots r_j$

$B(i,j) = 0$ for all i, j with $i \geq j-4$; otherwise

$B(i,j) = \max$ of:

$$\left\{ \begin{array}{l} B(i,j-1) \\ \max \{ B(i,k-1) + 1 + B(k+1,j-1) \mid \\ \quad i \leq k < j-4 \text{ and } r_k - r_j \text{ may pair} \} \end{array} \right.$$

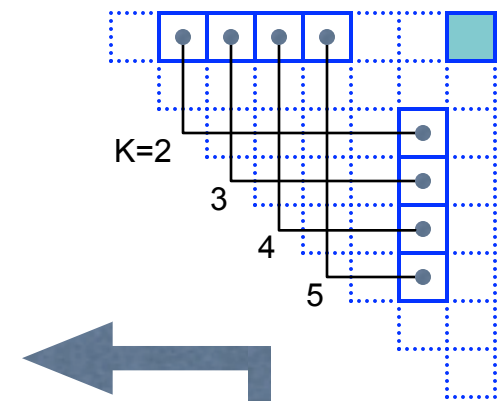
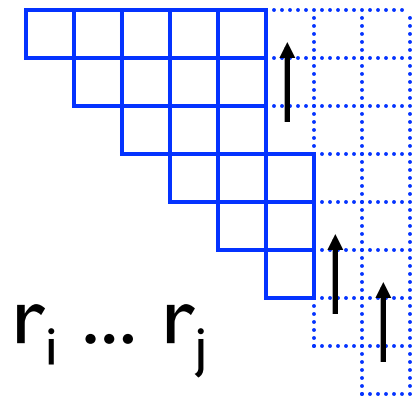

Time: $O(n^3)$

Loop-based energy version is better; recurrences similar, slightly messier

Approaches, II

Comparative sequence analysis

- + handles all pairings (potentially incl. pseudoknots)
- requires several (many?) aligned, appropriately diverged sequences

Stochastic Context-free Grammars

Roughly combines min energy & comparative, but no pseudoknots

Physical experiments (x-ray crystallography, NMR)

Today

P2

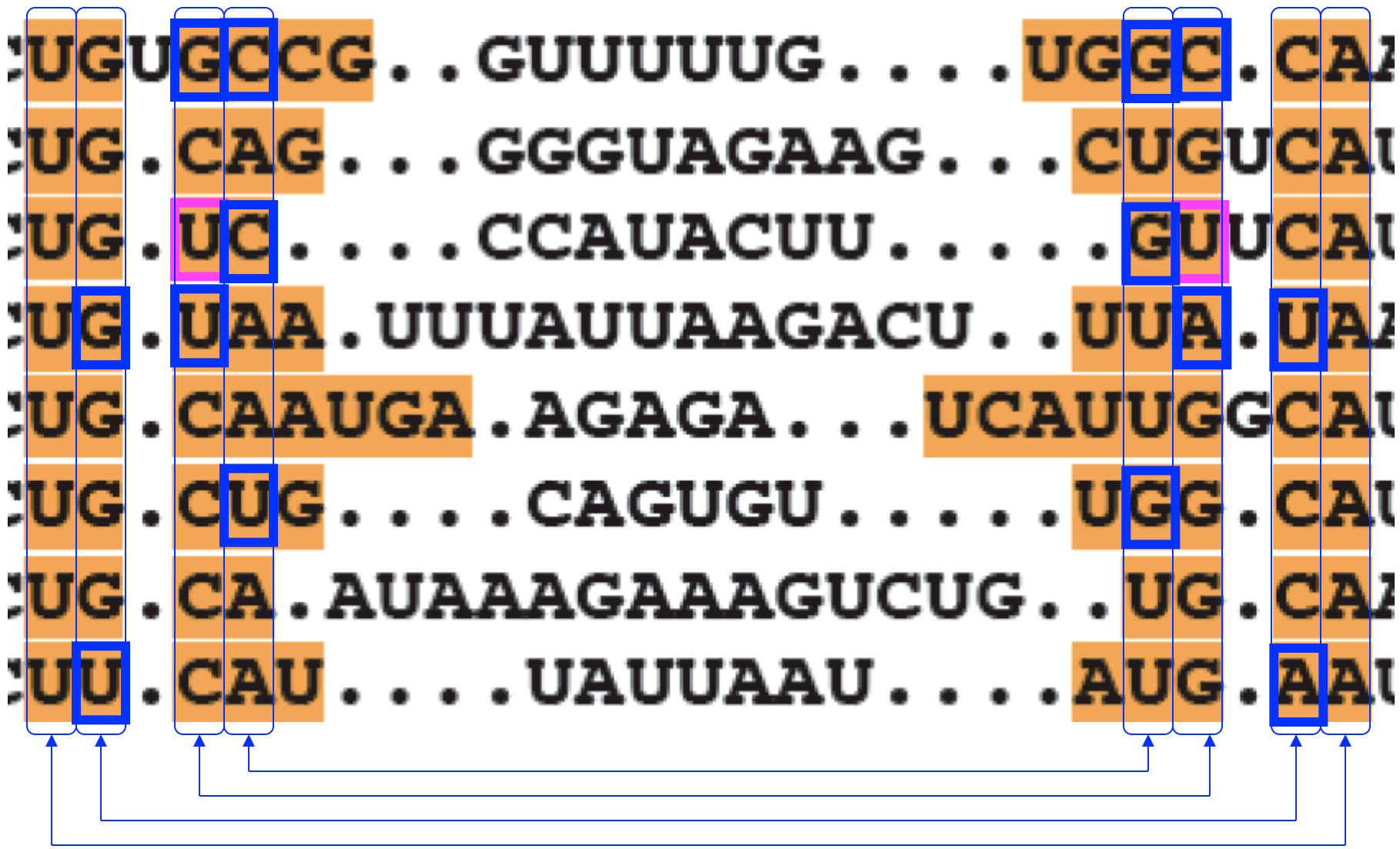

Covariation is strong evidence for base pairing

Example: Ribosomal Autoregulation: Excess L19 represses L19 (RF00556; 555-559 similar)

A L19 (*rplS*) mRNA leader

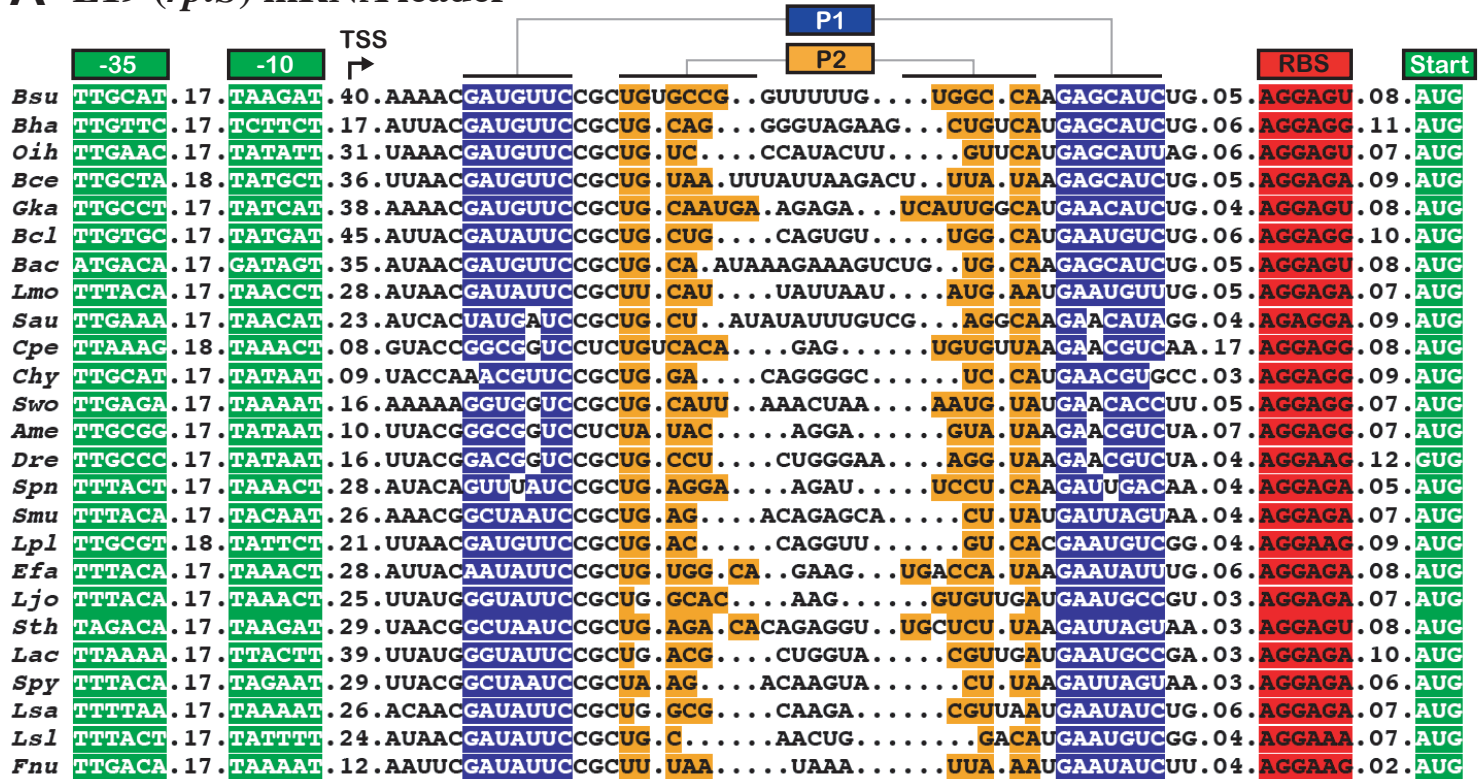

B

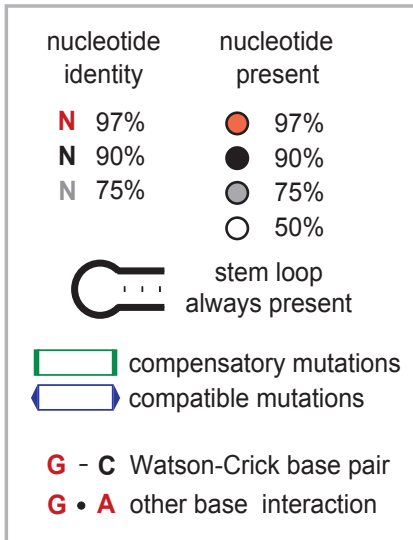
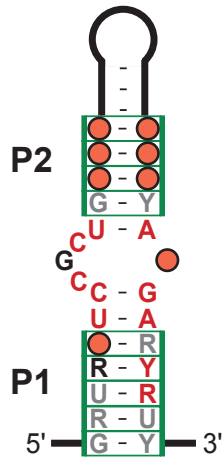

C

B. subtilis L19 mRNA leader

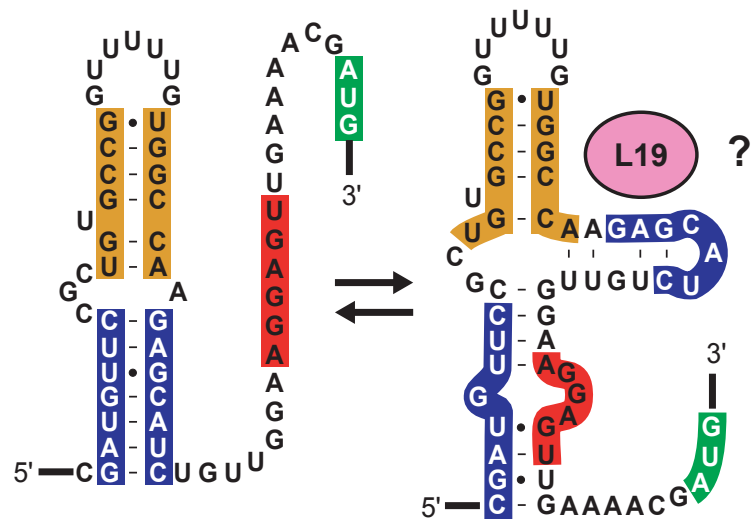

Mutual Information

$$M_{ij} = \sum_{x_i, x_j} f_{x_i, x_j} \log_2 \frac{f_{x_i, x_j}}{f_{x_i} f_{x_j}}; \quad 0 \leq M_{ij} \leq 2$$

Max when *no* seq conservation but perfect pairing

MI = expected score gain from using a pair state (below)

Finding optimal MI, (i.e. opt pairing of cols) is hard(?)

Finding optimal MI *without pseudoknots* can be done by dynamic programming

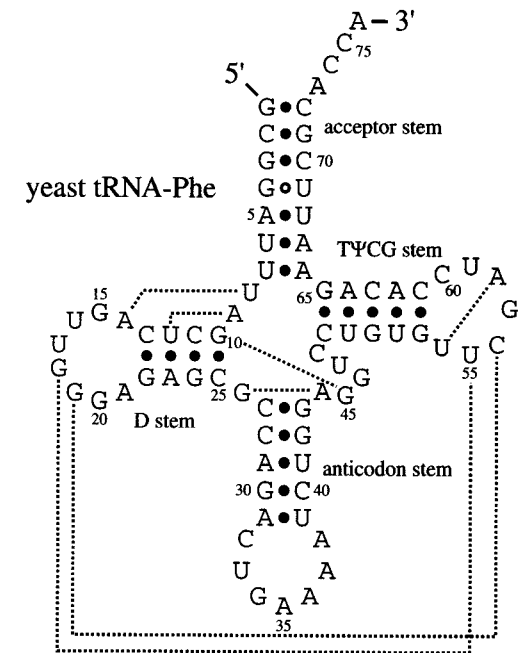
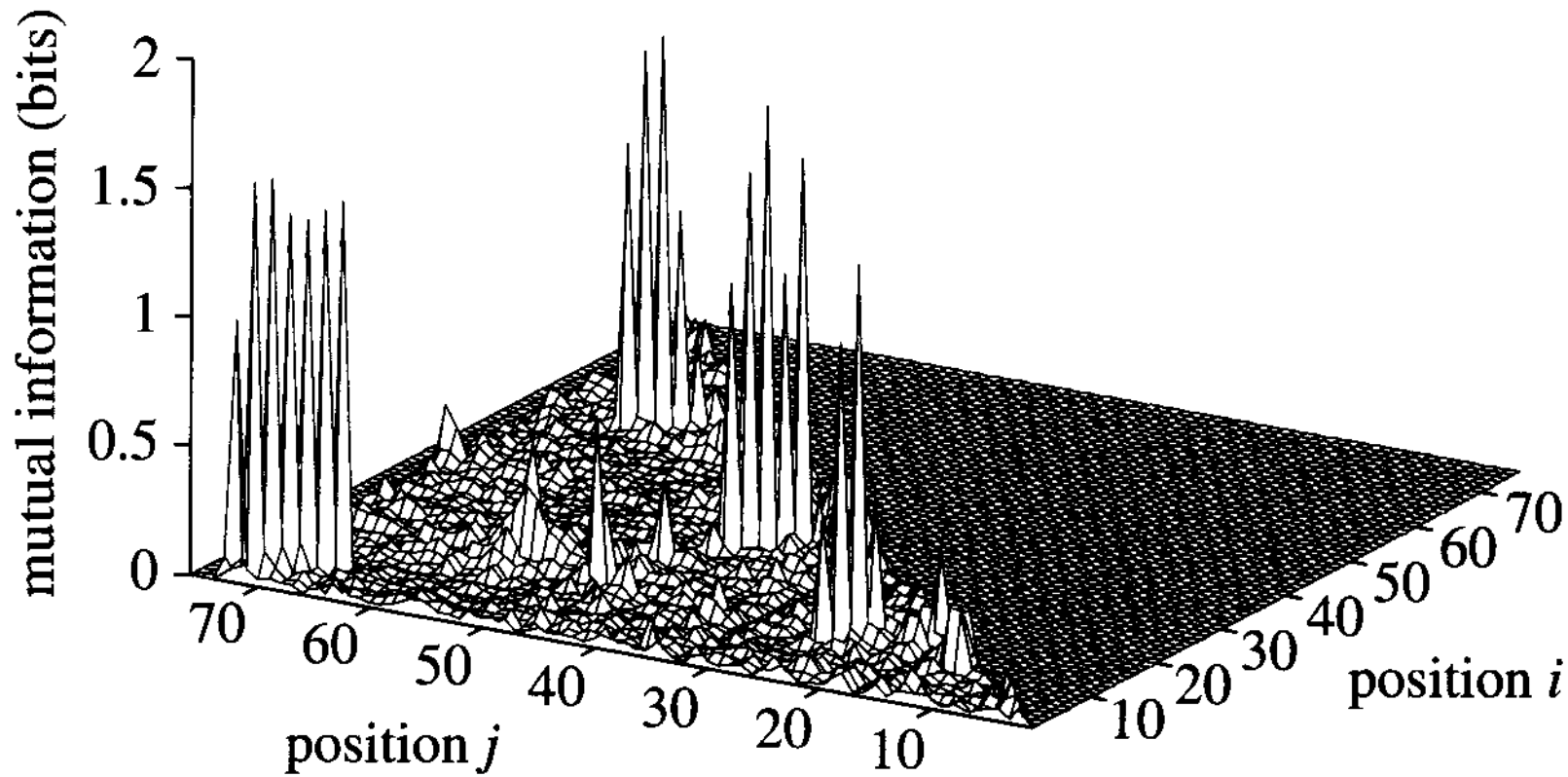

Figure 10.6 A mutual information plot of a tRNA alignment (top) shows four strong diagonals of covarying positions, corresponding to the four stems of the tRNA cloverleaf structure (bottom; the secondary structure of yeast phenylalanine tRNA is shown). Dashed lines indicate some of the additional tertiary contacts observed in the yeast tRNA-Phe crystal structure. Some of these tertiary contacts produce correlated pairs which can be seen weakly in the mutual information plot.

MI-Based Structure-Learning

Problem: Find best (max total MI) pseudo-knot-free subset of column pairs among $i \dots j$.

Solution: “Just like Nussinov/Zucker folding”

$$S_{i,j} = \max \begin{cases} S_{i,j-1} & j \text{ unpaired} \\ \max_{i \leq k < j-4} S_{i,k-1} + M_{k,j} + S_{k+1,j-1} & j \text{ paired} \end{cases}$$

BUT, need the right data—enough sequences at the right phylogenetic distance

Computational Problems

~~How to predict secondary structure~~

How to model an RNA “motif”
(i.e., sequence/structure pattern)

Given a motif, how to search for instances

Given (unaligned) sequences, find motifs

How to score discovered motifs

How to leverage prior knowledge

Motif Description

RNA Motif Models

“Covariance Models” (Eddy & Durbin 1994)

aka profile stochastic context-free grammars

aka hidden Markov models on steroids

Model position-specific nucleotide preferences *and* base-pair preferences

Pro: accurate

Con: model building hard, search slow

Eddy & Durbin 1994: What

A probabilistic model for RNA families

The “Covariance Model”

≈ A Stochastic Context-Free Grammar

A generalization of a profile HMM

Algorithms for Training

From aligned or unaligned sequences

Automates “comparative analysis”

Complements Nussinov/Zucker RNA folding

Algorithms for searching

Main Results

Very accurate search for tRNA

(Precursor to tRNAscanSE – a very good tRNA-finder)

Given sufficient data, model construction comparable to, but not quite as good as, human experts

Some quantitative info on importance of pseudoknots and other tertiary features

Probabilistic Model Search

As with HMMs, given a sequence:

You calculate likelihood ratio that the model could generate the sequence, vs a background model

You set a score threshold

Anything above threshold → a “hit”

Scoring:

“Forward” / “Inside” algorithm - sum over all paths

Viterbi approximation - find single best path

(Bonus: alignment & structure prediction)

Example: searching for tRNAs

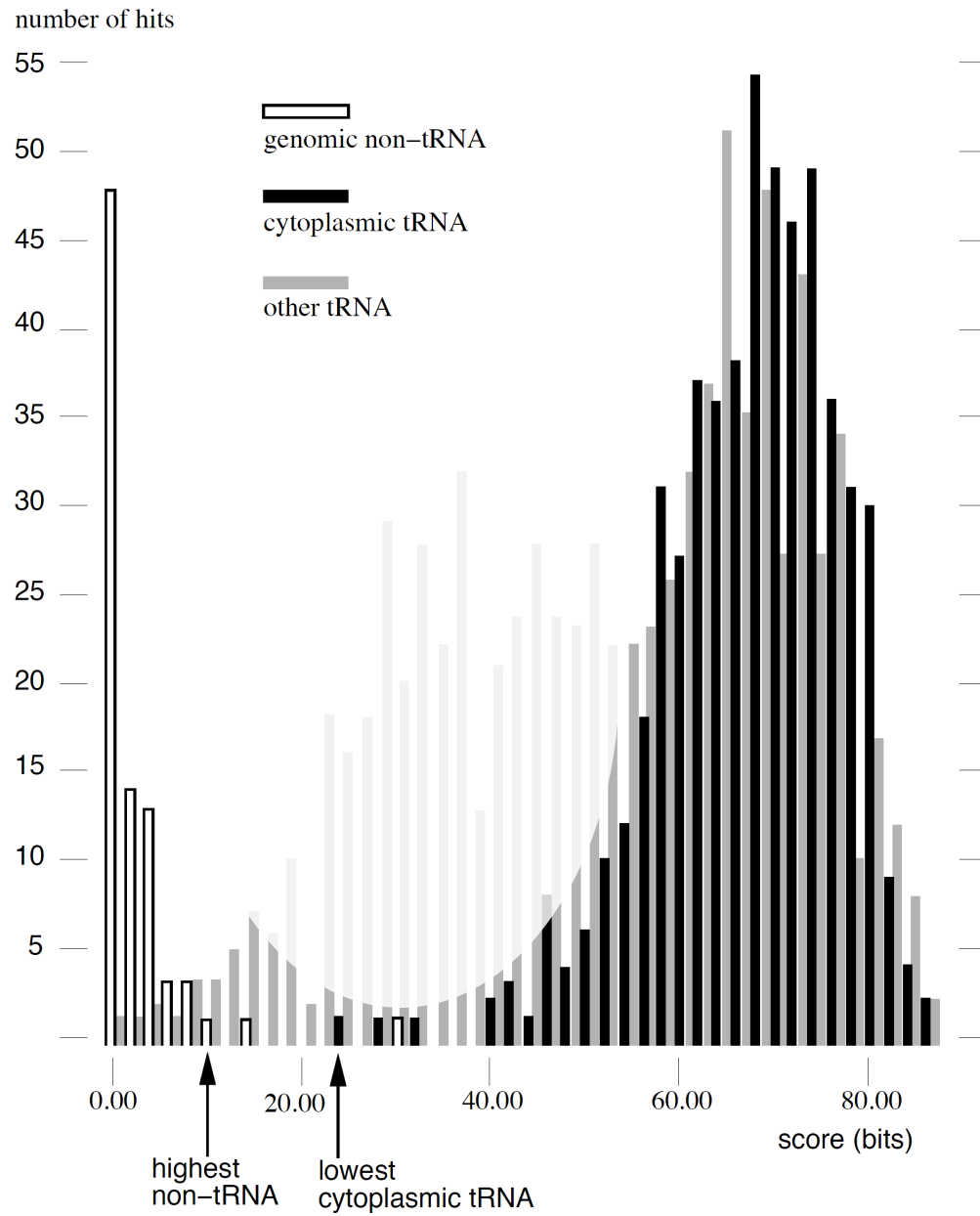

Recall

Profile HMM Structure

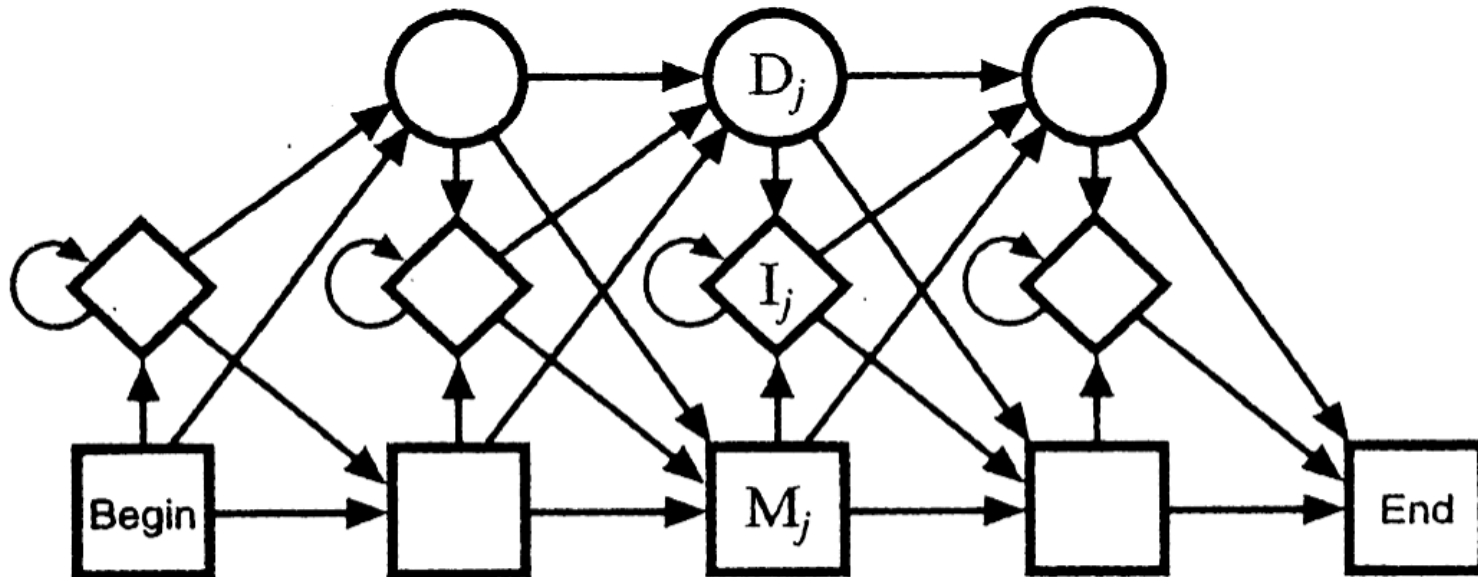

Figure 5.2 *The transition structure of a profile HMM.*

- M_j: Match states (20 emission probabilities)
- I_j: Insert states (Background emission probabilities)
- D_j: Delete states (silent - no emission)

How to model an RNA “Motif”?

Conceptually, start with a profile HMM:

from a multiple alignment, estimate nucleotide/ insert/delete preferences for each position

given a new seq, estimate likelihood that it could be generated by the model, & align it to the model

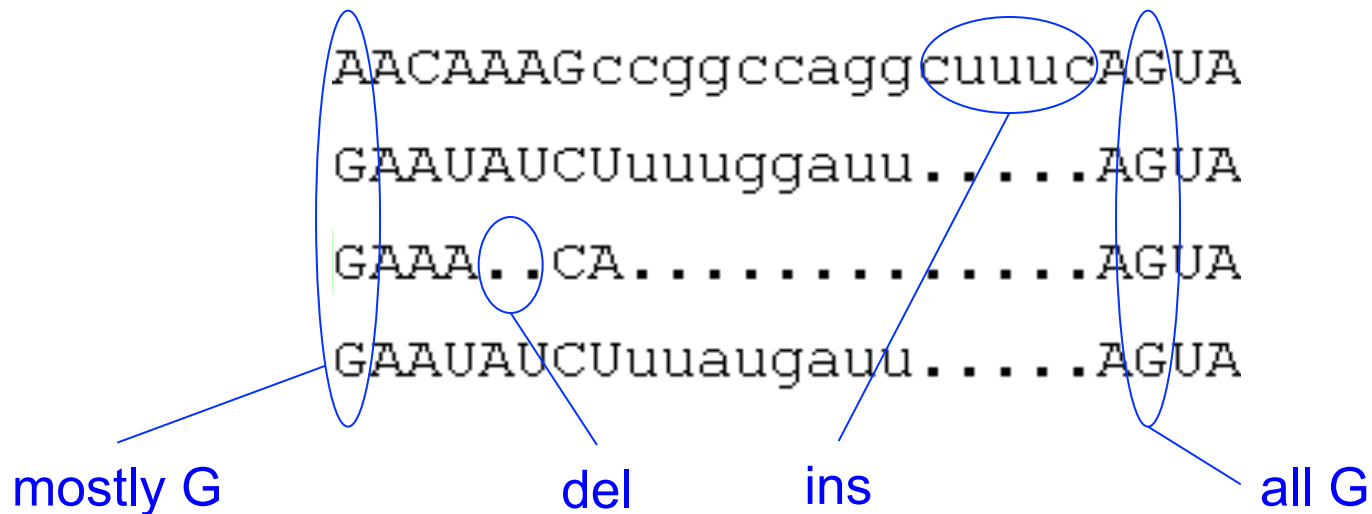

How to model an RNA “Motif”?

Add “column pairs” and pair emission probabilities for base-paired regions

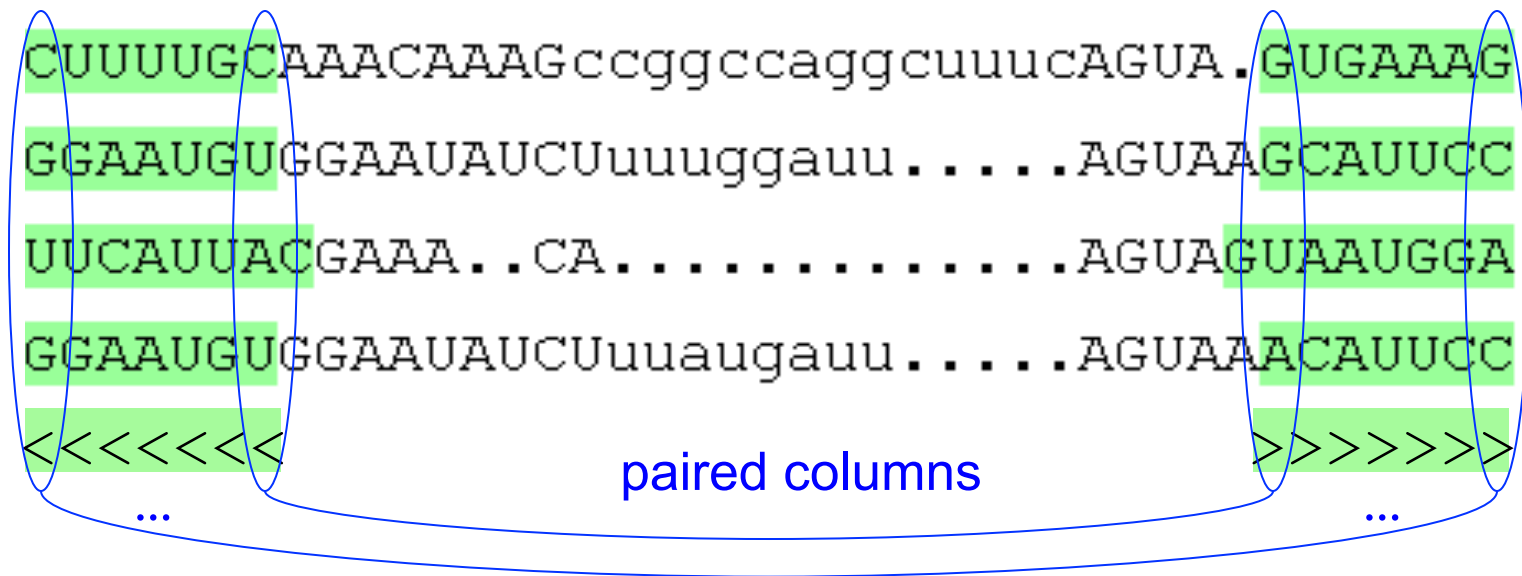

Profile HMM Structure

Does not handle "paired columns" above

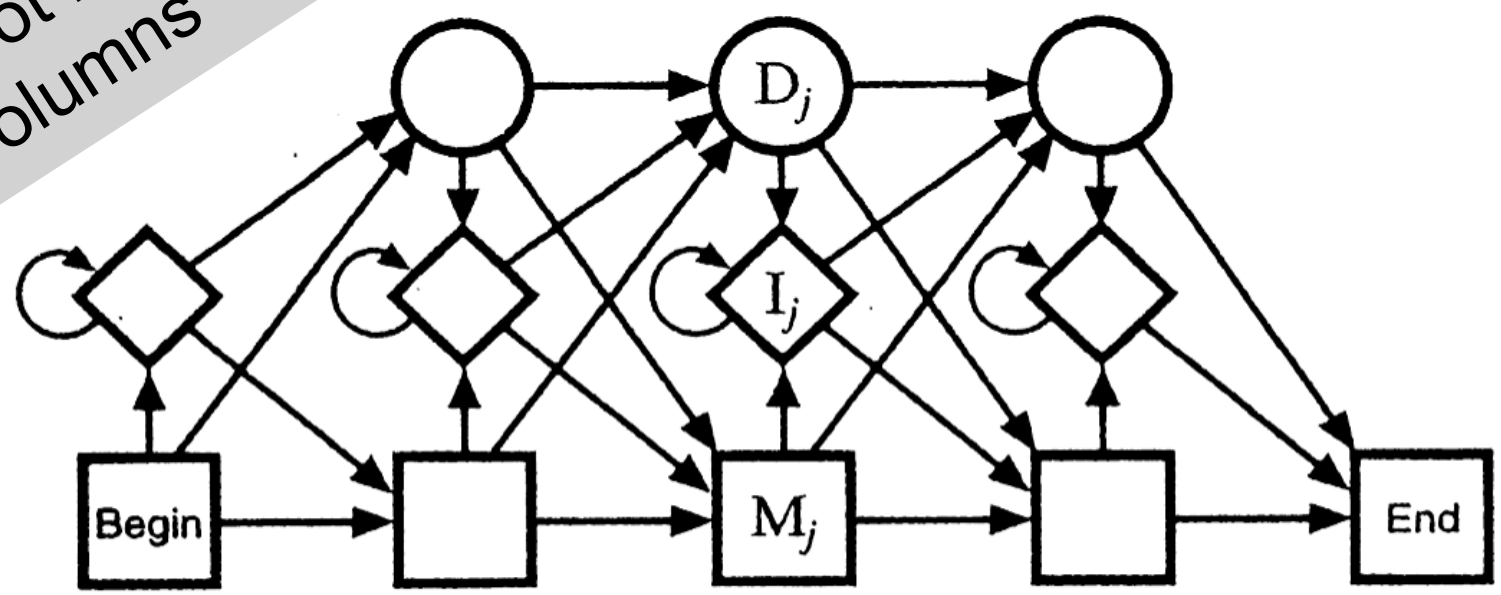

Figure 5.2 *The transition structure of a profile HMM.*

- M_j: Match states (20 emission probabilities)
- I_j: Insert states (Background emission probabilities)
- D_j: Delete states (silent - no emission)

CM Structure

A: Sequence + structure

B: the CM “guide tree”

C: probabilities of letters/ pairs & of indels

Think of each branch being an HMM emitting *both* sides of a helix (but 3' side emitted in reverse order)

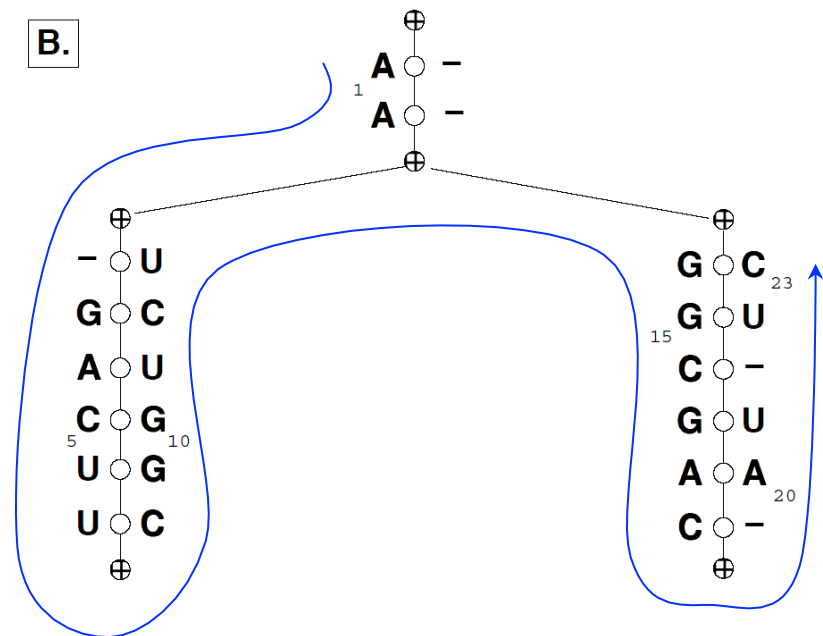
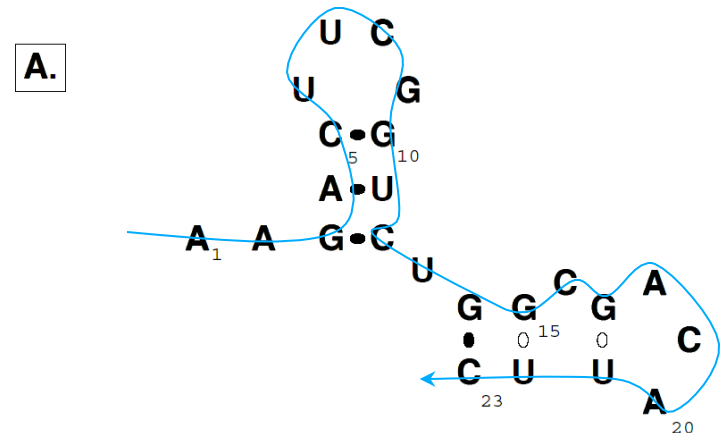

CM Viterbi Alignment

(the “inside” algorithm)

x_i = i^{th} letter of input

x_{ij} = substring i, \dots, j of input

T_{yz} = P (transition $y \rightarrow z$)

E_{x_i, x_j}^y = P (emission of x_i, x_j from state y)

S_{ij}^y = $\max_{\pi} \log P(x_{ij} \text{ gen'd starting in state } y \text{ via path } \pi)$

CM Viterbi Alignment

(the “inside” algorithm)

$$S_{ij}^y = \max_{\pi} \log P(x_{ij} \text{ generated starting in state } y \text{ via path } \pi)$$

$$S_{ij}^y = \begin{cases} \max_z [S_{i+1,j-1}^z + \log T_{yz} + \log E_{x_i, x_j}^y] & \text{match pair} \\ \max_z [S_{i+1,j}^z + \log T_{yz} + \log E_{x_i}^y] & \text{match/insert left} \\ \max_z [S_{i,j-1}^z + \log T_{yz} + \log E_{x_j}^y] & \text{match/insert right} \\ \max_z [S_{i,j}^z + \log T_{yz}] & \text{delete} \\ \max_{i < k \leq j} [S_{i,k}^{y_{left}} + S_{k+1,j}^{y_{right}}] & \text{bifurcation} \end{cases}$$



Time $O(qn^3)$, q states, seq len n
 compare: $O(qn)$ for profile HMM

Primary vs Secondary Info

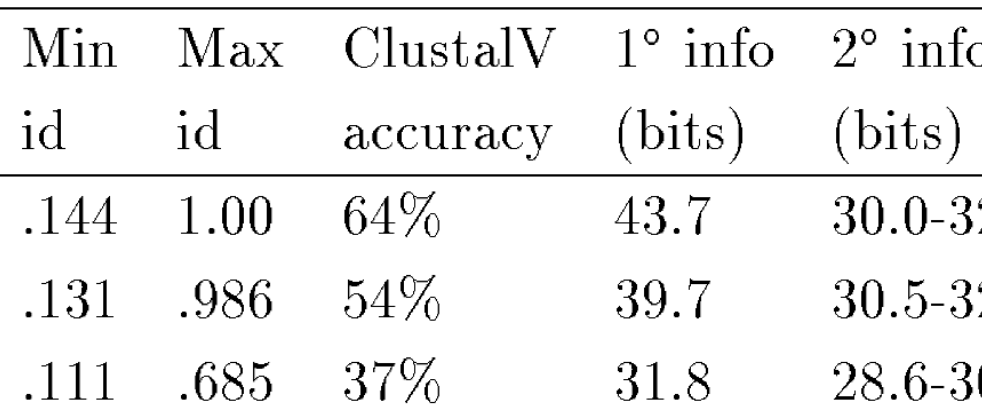

	Avg.	Min	Max	ClustalV	1° info	2° info
Dataset	id	id	id	accuracy	(bits)	(bits)
TEST	.402	.144	1.00	64%	43.7	30.0-32.3
SIM100	.396	.131	.986	54%	39.7	30.5-32.7
SIM65	.362	.111	.685	37%	31.8	28.6-30.7

disallowing / allowing
pseudoknots

$$\left(\sum_{i=1}^n \max_j M_{i,j} \right) / 2$$

An Important Application: Rfam

A Database of RNA Families

RF00037:

Example Rfam Family

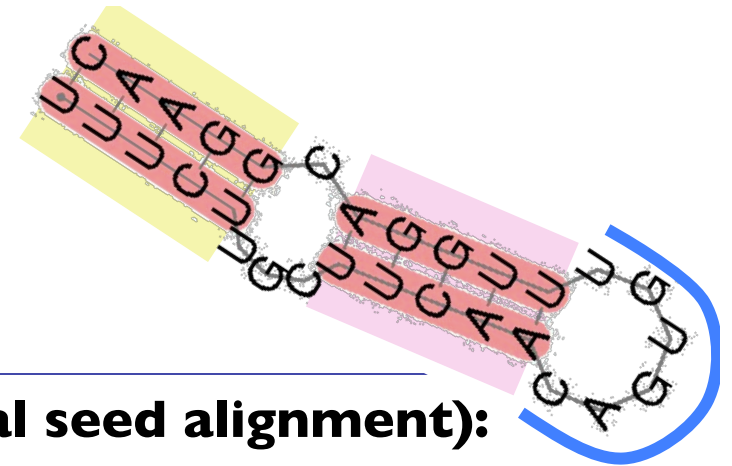

Input (hand-curated):

MSA “seed alignment”

SS_cons

Score Thresh T

Window Len W

Output:

CM

scan results & “full alignment”

phylogeny, etc.

IRE (partial seed alignment):

Hom. sap.	GUUCCUGCUUCAACAGUGUUUGGAUGGAAC
Hom. sap.	UUUCUUC.UUCAACAGUGUUUGGAUGGAAC
Hom. sap.	UUUCCUGUUUCAACAGUGCUUGGA.GGAAC
Hom. sap.	UUUAUC..AGUGACAGAGUUCACU.AUAAA
Hom. sap.	UCUCUUGCUUCAACAGUGUUUGGAUGGAAC
Hom. sap.	AUUAUC..GGGAACAGUGUUUCCC.AUAAU
Hom. sap.	UCUUGC..UUCAACAGUGUUUGGACGGAAG
Hom. sap.	UGUAUC..GGAGACAGUGAUCUCC.AUAUG
Hom. sap.	AUUAUC..GGAAGCAGUGCCUCC.AUAAU
Cav. por.	UCUCCUGCUUCAACAGUGCUUGGACGGAGC
Mus. mus.	UAUAUC..GGAGACAGUGAUCUCC.AUAUG
Mus. mus.	UUUCCUGCUUCAACAGUGCUUGAACGGAAC
Mus. mus.	GUACUUGCUUCAACAGUGUUUGAACGGAAC
Rat. nor.	UAUAUC..GGAGACAGUGACCUCC.AUAUG
Rat. nor.	UAUCUUGCUUCAACAGUGUUUGGACGGAAC
SS_cons	<<<<<...<<<<<.....>>>>>. >>>>>

Rfam – an RNA family DB

Griffiths-Jones, et al., NAR '03, '05, '08, '11, '12

Was biggest scientific comp user in Europe - 1000
cpu cluster for a month per release

Rapidly growing:

Rel 1.0, 1/03:	25 families, 55k instances	DB size:
Rel 7.0, 3/05:	503 families, 363k instances	~8GB
Rel 9.0, 7/08:	603 families, 636k instances	
Rel 9.1, 1/09:	1372 families, 1148k instances	
Rel 10.0, 1/10:	1446 families, 3193k instances	~160GB
Rel 11.0, 8/12:	2208 families, 6125k instances	~320GB
Rel 12.0, 9/14:	2450 families, 19623k instances	

CM Summary

Covariance Models (CMs) represent conserved RNA sequence/structure motifs

They allow accurate search

But

- a) search is slow
- b) model construction is laborious

An Important Need: Faster Search

Homology search

“Homolog” – similar by descent from common ancestor

Sequence-based

Smith-Waterman

FASTA

BLAST

For RNA, sharp decline in sensitivity at ~60-70% identity

So, use structure, too

Impact of RNA homology search

(Barrick, *et al.*, 2004)

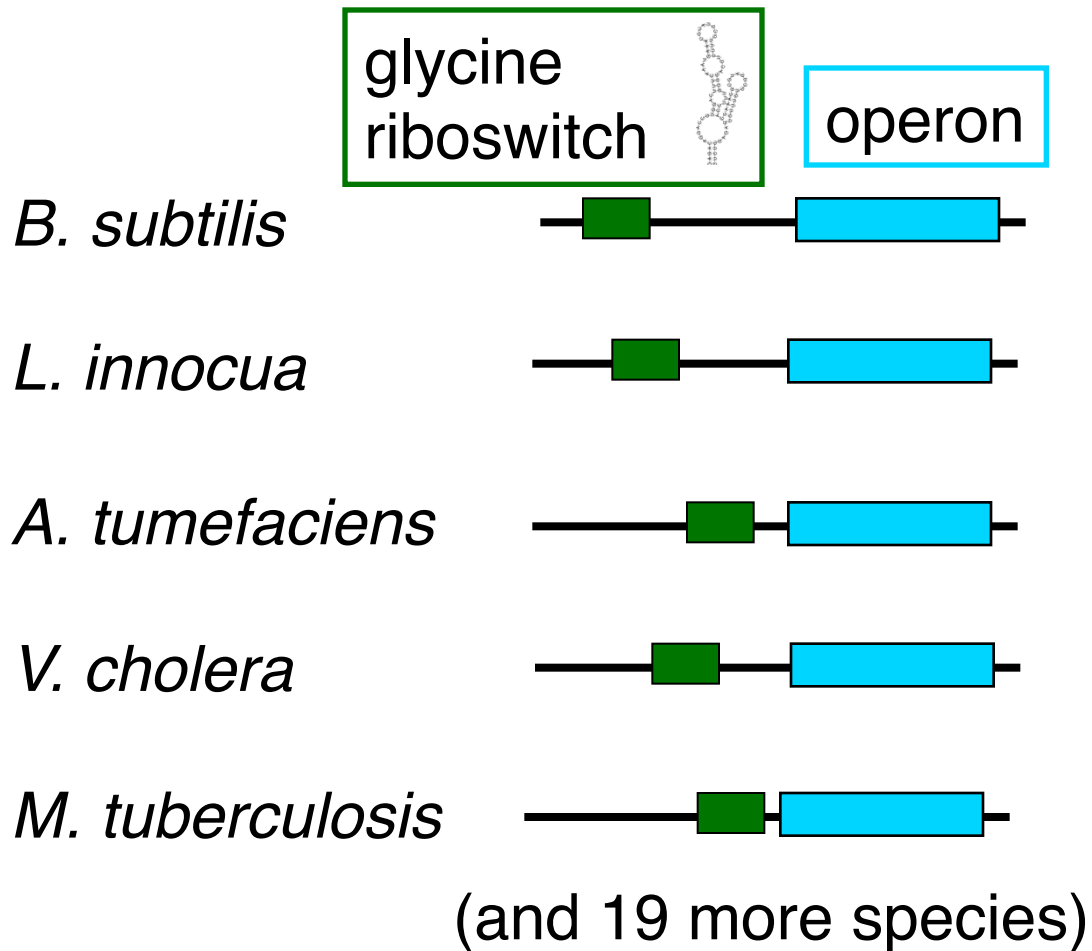

Impact of RNA homology search

(Barrick, *et al.*, 2004)

(Mandal, *et al.*, 2004)

glycine
riboswitch



operon

B. subtilis



L. innocua



A. tumefaciens



V. cholera



M. tuberculosis



(and 19 more species)

BLAST-based

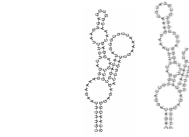

(and 42 more species)

CM-based

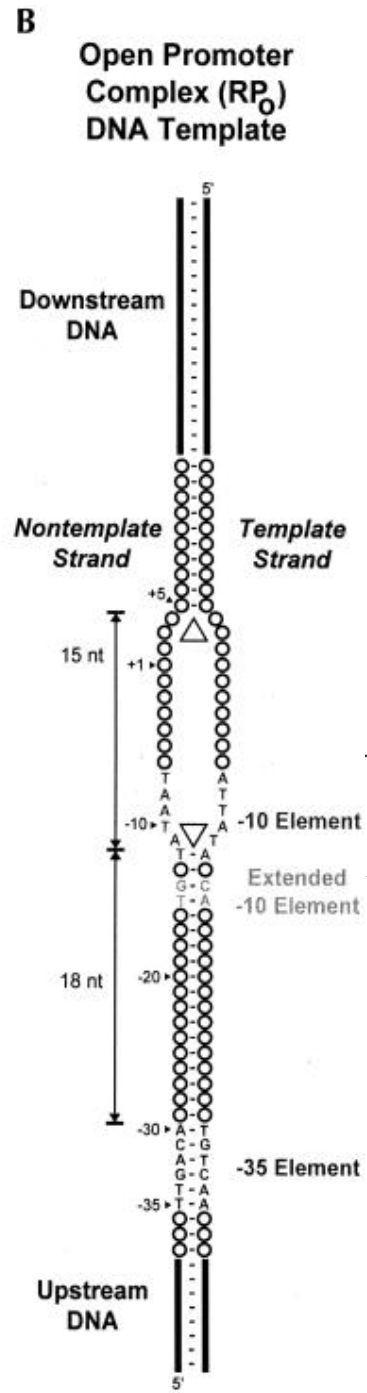
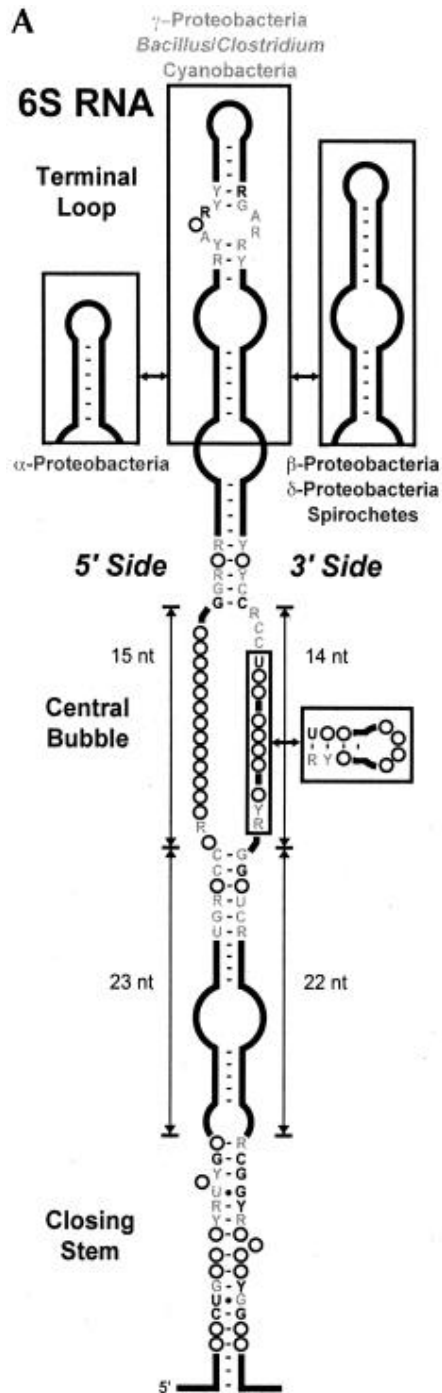

6S mimics an open promoter

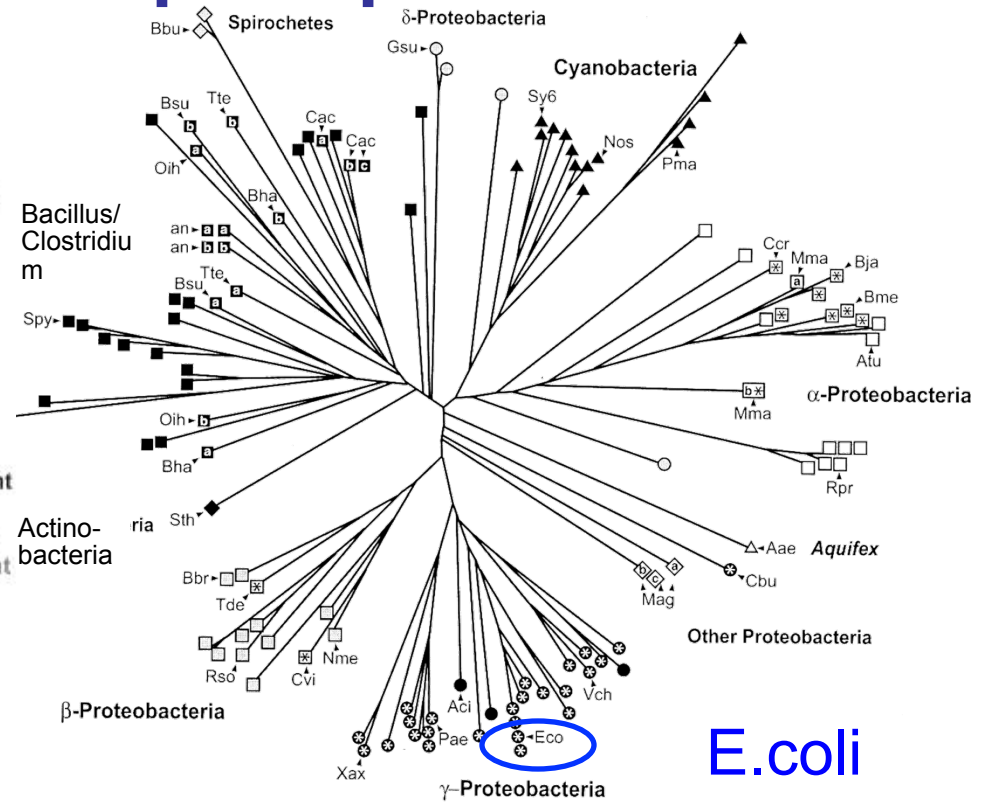

E.coli

Barrick et al. *RNA* 2005
Trotochaud et al. *NSMB* 2005
Willkomm et al. *NAR* 2005

Faster Genome Annotation of Non-coding RNAs Without Loss of Accuracy

Zasha Weinberg

& W.L. Ruzzo

Recomb '04, ISMB '04, Bioinfo '06

CM's are good, but slow

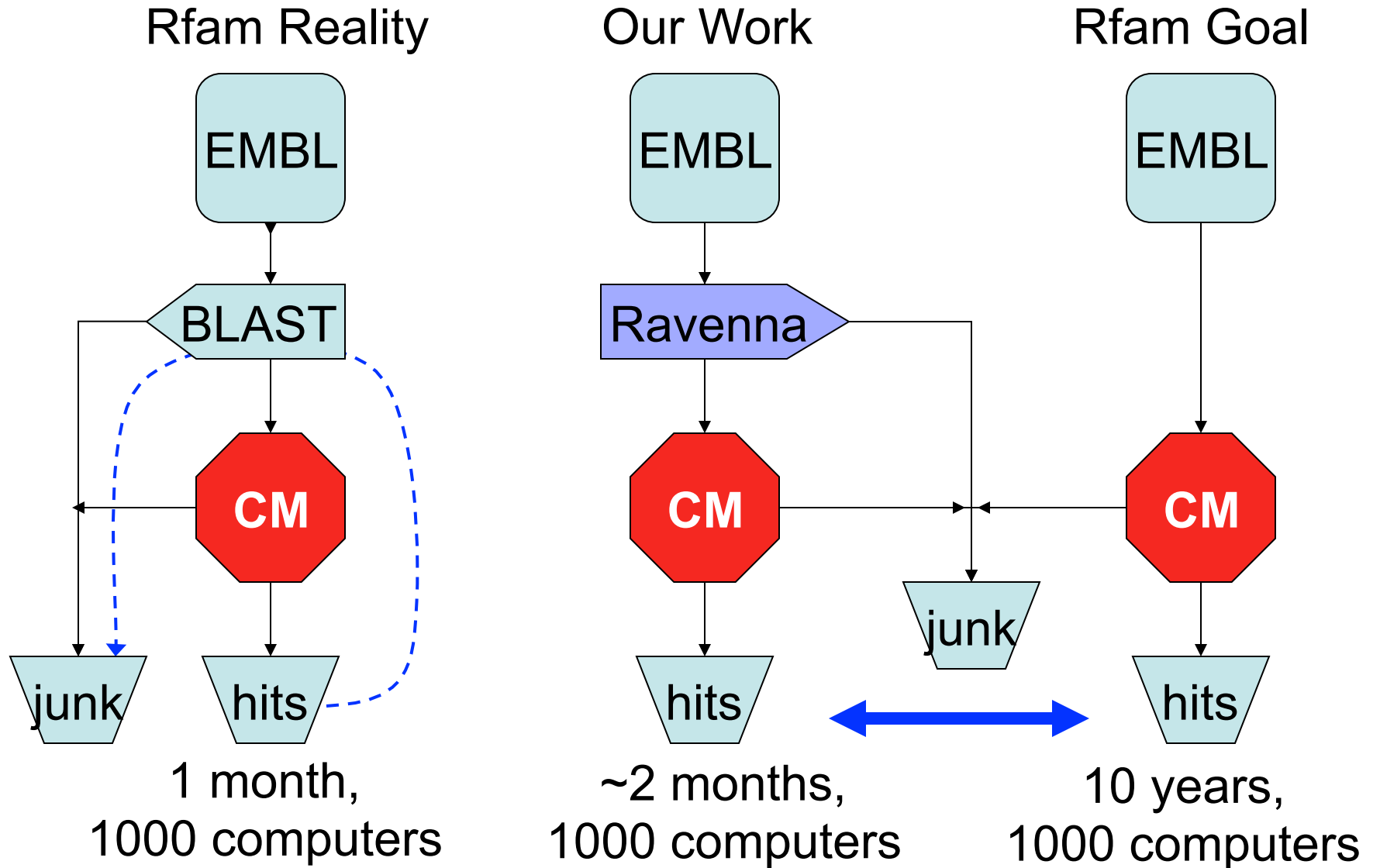

CM to HMM

CM

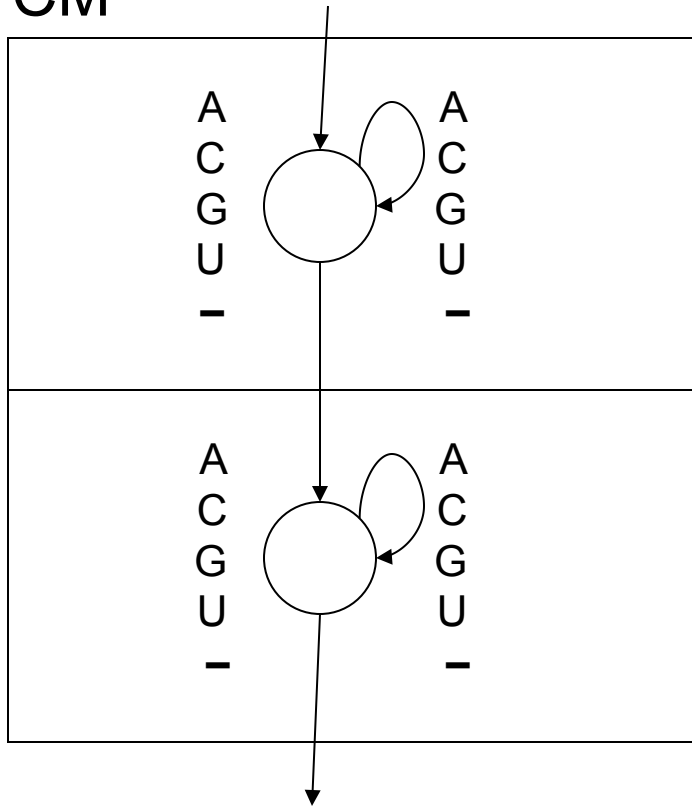

25 emissions per state

HMM

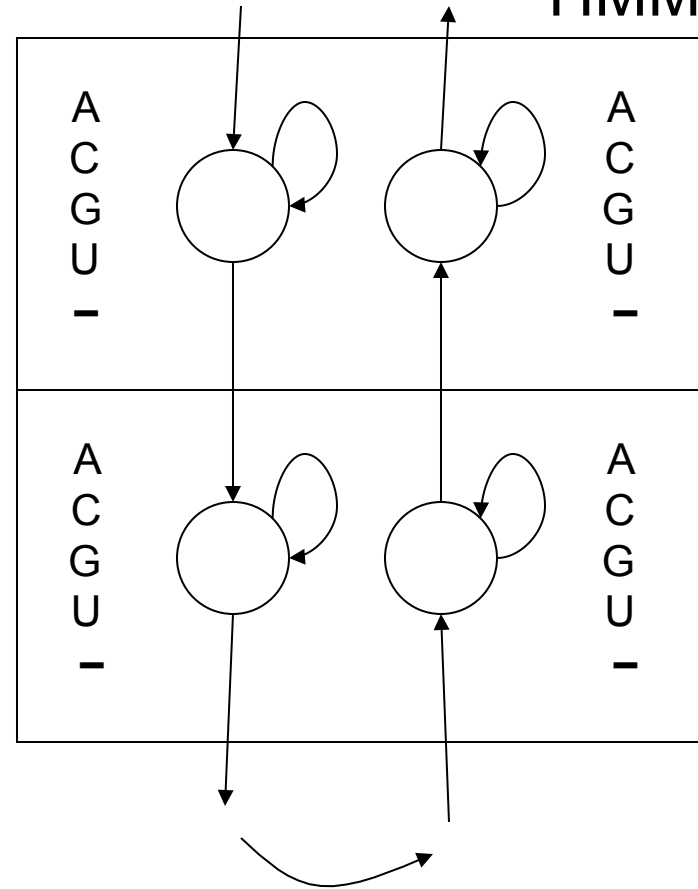

5 emissions per state, 2x states

Key Issue: 25 scores \rightarrow 10

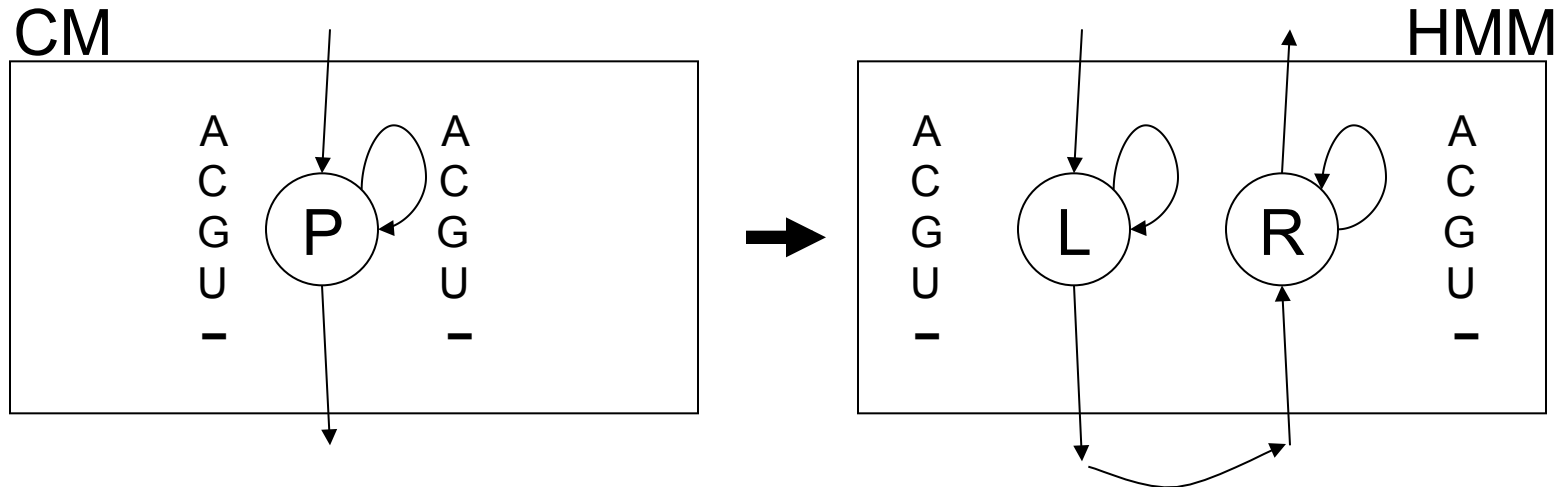

Need: \log Viterbi scores $\text{CM} \leq \text{HMM}$

$P_{AA} \leq L_A + R_A$	$P_{CA} \leq L_C + R_A$...
$P_{AC} \leq L_A + R_C$	$P_{CC} \leq L_C + R_C$...
$P_{AG} \leq L_A + R_G$	$P_{CG} \leq L_C + R_G$...
$P_{AU} \leq L_A + R_U$	$P_{CU} \leq L_C + R_U$...
$P_{A-} \leq L_A + R_-$	$P_{C-} \leq L_C + R_-$...

NB: HMM not a prob. model

Assignment of scores/ “probabilities”

Convex optimization problem

Constraints: enforce rigorous property

Objective function: filter as aggressively as possible

Problem sizes:

1000-10000 variables

10000-100000 inequality constraints

“Convex” Optimization

Convex:

local max = global max;
simple “hill climbing” works

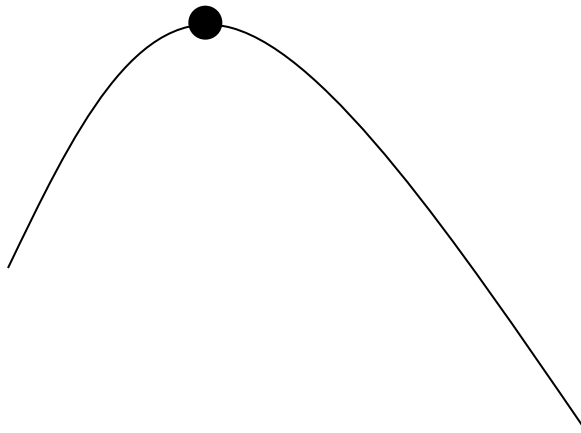

Nonconvex:

can be many local maxima,
≪ global max;
“hill-climbing” fails

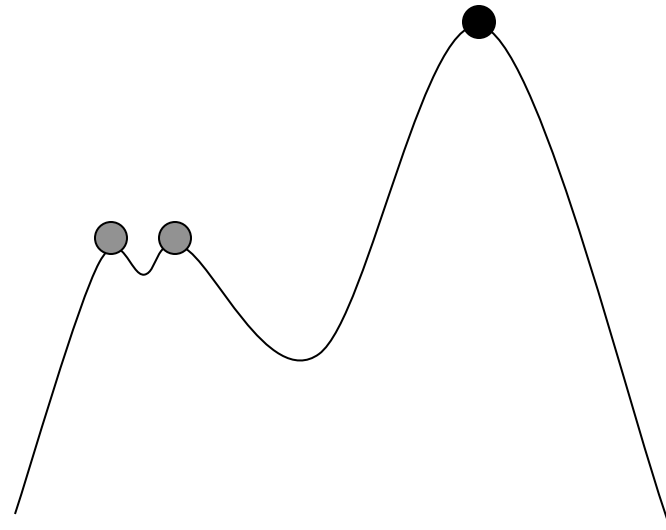

Estimated Filtering Efficiency

(139 Rfam 4.0 families)

Filtering fraction	# families (compact)	# families (expanded)
$< 10^{-4}$	105	110
$10^{-4} - 10^{-2}$	8	17
.01 - .10	11	3
.10 - .25	2	2
.25 - .99	6	4
.99 - 1.0	7	3

\approx break even

~100x speedup

Averages 283 times faster than CM

Results: new ncRNAs (?)

Name	# Known (BLAST + CM)	# New (rigorous filter + CM)
<i>Pyrococcus</i> snoRNA	57	123
Iron response element	201	121
Histone 3' element	1004	102*
Retron msr	11	48
Hammerhead I	167	26
Hammerhead III	251	13
U6 snRNA	1462	2
U7 snRNA	312	1
cobalamin riboswitch	170	7
13 other families	5-1107	0

CM Search Summary

Still slower than we might like, but dramatic speedup over raw CM is possible with:

- No loss in sensitivity (provably), or

- Even faster with modest (and estimable) loss in sensitivity

Motif Discovery

RNA Motif Discovery

CM's are great, but where do they come from?

Key approach: comparative genomics

Search for motifs with common secondary structure in a set of functionally related sequences.

Challenges

Three related tasks

Locate the motif regions.

Align the motif instances.

Predict the consensus secondary structure.

Motif search space is huge!

Motif location space, alignment space, structure space.

Approaches

Align-First: Align sequences, then look for common structure

Fold-First: Predict structures, then try to align them

Joint: Do both together

“Align First” Approach: Predict Struct from Multiple Alignment

... GA ... UC ...
... GA ... UC ...
... GA ... UC ...
... CA ... UG ...
... CC ... GG ...
... UA ... UA ...

Compensatory mutations reveal structure (core of “comparative sequence analysis”) *but* usual alignment algorithms penalize them (twice)

Pitfall for sequence-alignment-first approach

Structural conservation \neq Sequence conservation
Alignment without structure information is unreliable

CLUSTALW alignment of SECIS elements with flanking regions

```
-----CCCCCCCAGGCTCCTGGTGCCCGG--ATGATGACGACCTGGGTG-GAA-A---CCTACCCCTGTGGCCACCC-ATGTCGA-GCCCCCTGGCATT
GGGATCATTGCAAGAGCAGCGTG--ACTGACATTA--TGAAGGCCTGTACTGAAGAAGCAA--GCTGTTAGTACAGACC---AGATG---CTTCTTGGCAGGCCTCGTTGTACCTCTTGGAAAACCTCAAT
AGGTTTGCATTAATGAGGATTACACAGAAAACCTTT-GTTAAGGTTTGTGTGATCTGCTAA--TTGGCAAATTTTTATTTTTAAAAT---ATTCTACAGAAGAGTTCATTTAAGAATGTTTCGTATAGG
AGTGTGCGGATGATAACTACTGACGAAAGAGTCATCGACTCAGTTAGTGGTTGGATGTAGTACATTAGTTCCTCTCCCCATCTTTG---TCTCCCTGGCAAGGAGAATATGCGGACATGATGCTAAGAG
TGGACTGATAGGTA-GCCATGGC--TTCATCTGTC--ATG--TCTGCTCTTTTTATATTG--TGTATGATGGTCACAGTGTAAG-G---TTCCACAGCTGTGACTTGATTTTTAA-AAATGTGGAAGA
TAAACTCGAACTCGAGCGGGCAATTGCTGATTACGA-TTAAACCACTGATTCTGGGTCGCTGC--TTCGTGGCCGTGTCGGTTCCA-----TTTATCAACTATTAGCTCCAATACATAGCTACAGGTTTTT
AAATTCTCGCTATATGACGATGGCAATCTCAAATGT-TCATTTGGTTGCCATTIGATGAAATCAGTTTTGTGTGACCTGATTGCAGAATTTTGTTTACCTTGCTCATTTTTTTTCATTGAA-ACCACTTCTCAGA
GGGGCGGGAGTACAAGGTGCGTGTGACTGGAGCCA--CCCCTCCGACTCTGCAGGTGTTG--CAAATGACGACCGATTTTGAAATG---GTCACCGCCAAAACTCGTGTCCGACATCAACCCCTTC
TTCTCCAGTGTCTAGTTACATTGATGAGAACAGAA-ACATAAACTATGACCTAGGGGTTTCT--GTTGGATAGCTCGTAATTAAGAACGGAGAAAGAACAAAGACATATTTCCAGTTTTTTTTCTTTAC
CAAACCTGATGGATA-GCCATTGGTATTCATCTATT--TTAACTCTGTGCTTTACATATTG--TTTATGATGGCCACAGCCTAAG-G---TACACACGGCTGTGACTTGATTCAAAA-GAAA-----
TGAGCAACTTGTCT-GATGACTGGGAAAGGAGGAC--CTGCAACCATCTGACTTGGTCTCTG--TTAATGACGCTCTCCCCCTAA-A---CCC-CATTAAGGACTGGGAGAGGCAGA-GCAAGCCTCAGAG
GATTACTGGCTGCACCTCTGGGGGGCGGTTCTTCCA--TGATGGTGTTCCTTAAATTTGCA--CGGAGAAACACCTGATTTCCAGGAAA-ATCCCTCAGATGGGCGCTGGTCCCATCCATTCCCGATGCCT
AGACCAGGCAAGACAACCTGTGAGC-GCGATGGCCG--TGTACCCAGGTGAGGGGTTGGTGTG--TCTATGAAGGAGGGGCCGAAG-----CCCTTGTGGGCGGGCCTCCCTGAGCCCGTCTGTGGTGCCAG
CACTTCAGAAGGCT-TCTGAATGGAACCATCTCTT--GACA-TTTGTTTCTATA-ATATTG--T-CATGACAGTACAGCATAAAA-G---CGCAGACGGCTGTGACTGATTTTAGA-AAATATTTTTAGA
```

same-colored boxes *should* be aligned

Approaches

Align-first: align sequences, then look for common structure

Fold-first: Predict structures, then try to align them

single-seq struct prediction only ~ 60% accurate; exacerbated by flanking seq; no biologically-validated model for structural alignment

Joint: Do both together

Sankoff – good but slow

Heuristic

Our Approach: CMfinder

RNA motifs from unaligned sequences

Simultaneous *local* alignment, folding and CM-based motif description via an EM-style learning procedure

Sequence conservation exploited, but not required

Robust to inclusion of unrelated and/or flanking sequence

Reasonably fast and scalable

Produces a probabilistic model of the motif that can be directly used for homolog search

Yao, Weinberg & Ruzzo, *Bioinformatics*, 2006

CMFinder

Simultaneous alignment, folding & motif description

Yao, Weinberg & Ruzzo, *Bioinformatics*, 2006

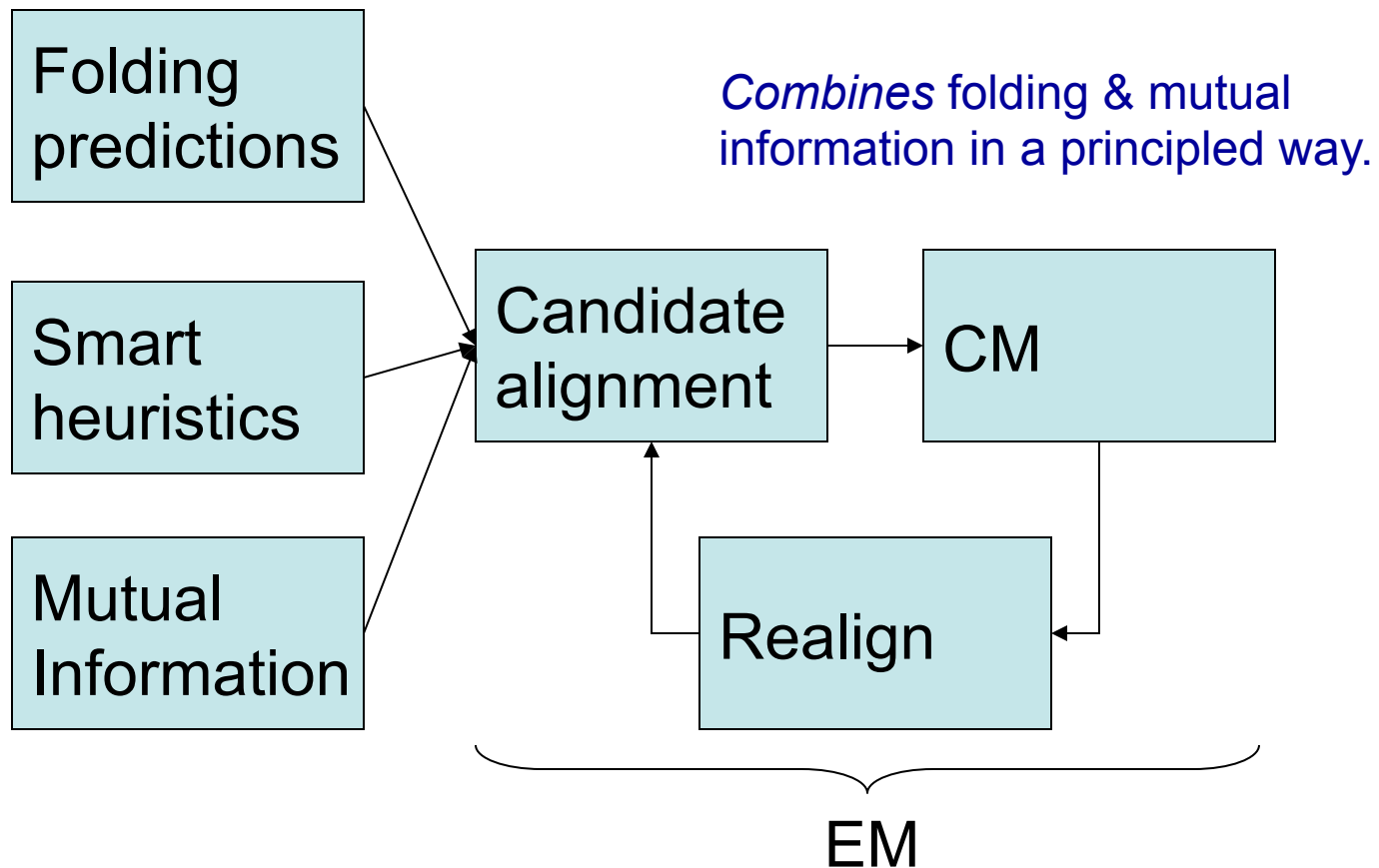

CMfinder Accuracy (on Rfam families *with* flanking sequence)

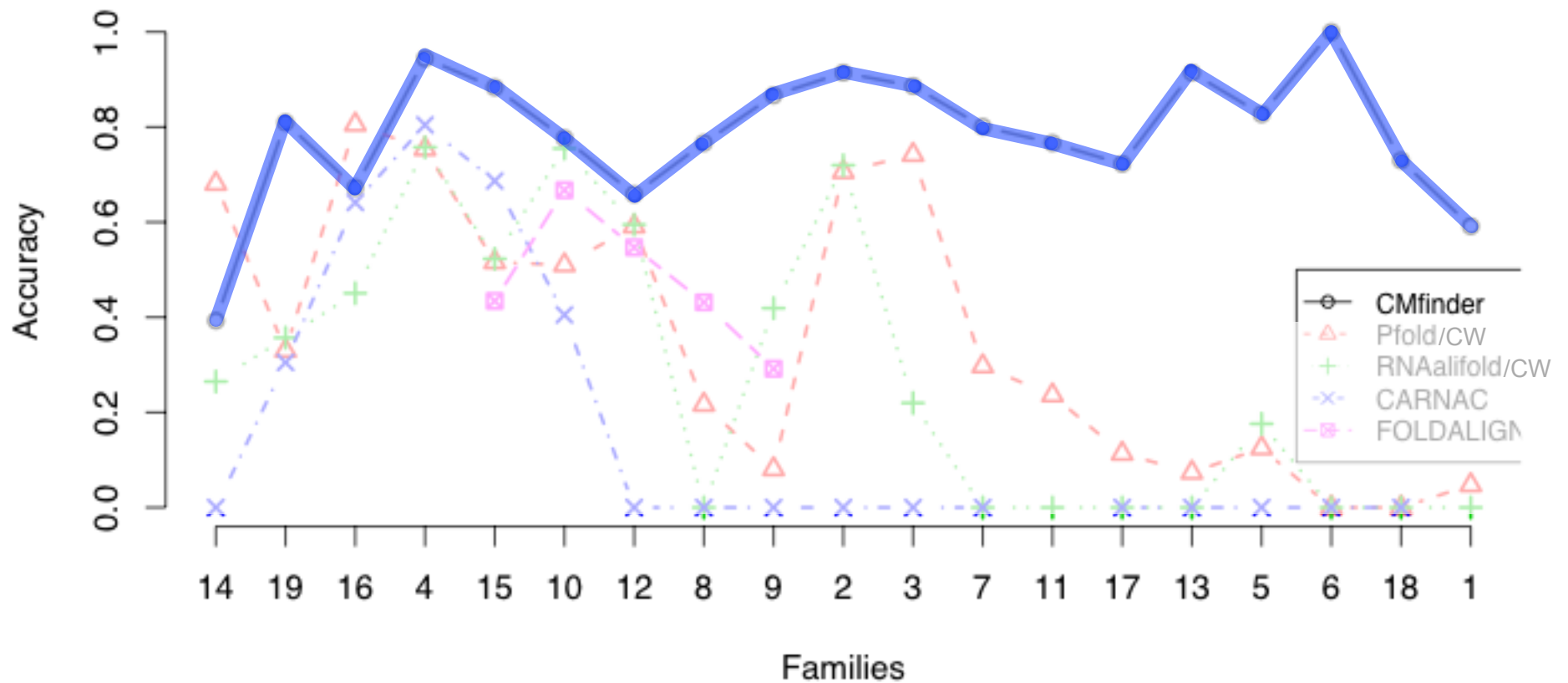

Discovery in Bacteria

OPEN ACCESS Freely available online

PLOS COMPUTATIONAL BIOLOGY

A Computational Pipeline for High-Throughput Discovery of *cis*-Regulatory Noncoding RNA in Prokaryotes

Zizhen Yao^{1*}, Jeffrey Barrick^{2a}, Zasha Weinberg³, Shane Neph^{1,4}, Ronald Breaker^{2,3,5}, Martin Tompa^{1,4},
Walter L. Ruzzo^{1,4}

Published online 9 July 2007

Nucleic Acids Research, 2007, Vol. 35, No. 14 4809–4819
doi:10.1093/nar/gkm487

Identification of 22 candidate structured RNAs in bacteria using the CMfinder comparative genomics pipeline

Zasha Weinberg^{1,*}, Jeffrey E. Barrick^{2,3}, Zizhen Yao⁴, Adam Roth², Jane N. Kim¹,
Jeremy Gore¹, Joy Xin Wang^{1,2}, Elaine R. Lee¹, Kirsten F. Block¹, Narasimhan Sudarsan¹,
Shane Neph⁵, Martin Tompa^{4,5}, Walter L. Ruzzo^{4,5} and Ronald R. Breaker^{1,2,3}

Approach

Get bacterial genomes

For each gene, get 10-30 close orthologs (CDD)

Find most promising genes, based on conserved sequence motifs (Footprinter)

From those, find structural motifs (CMfinder)

Genome-wide search for more instances (Ravenna)

Expert analyses (Breaker Lab, Yale)

Processing Times

Input from ~70 complete Firmicute genomes available in late 2005-early 2006, totaling ~200 megabases

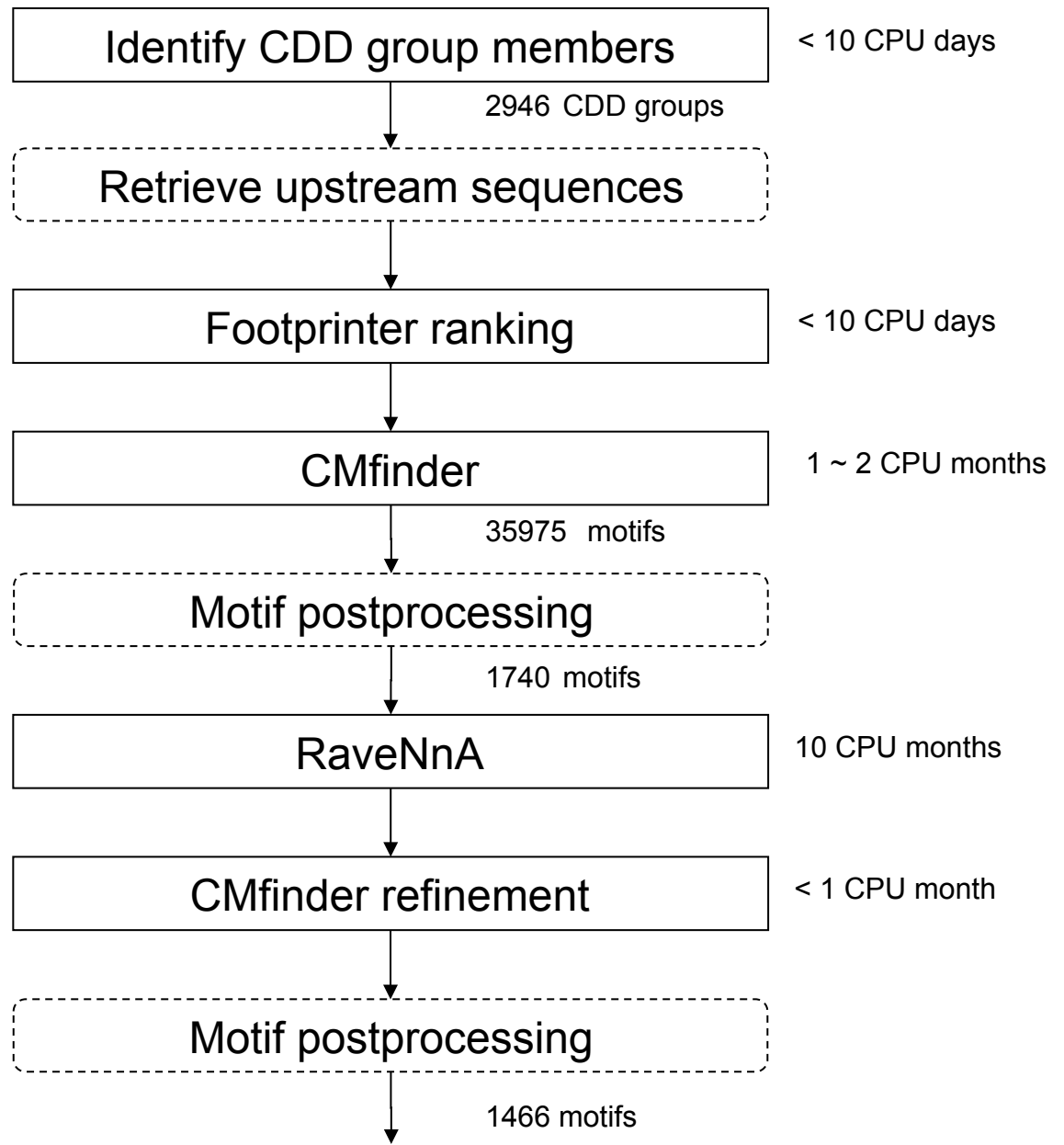

Table I: Motifs that correspond to Rfam families

Rank			Score	#		CDD			Rfam
RAV	CMF	FP		RAV	CMF	ID	Gene	Description	
0	43	107	3400	367	11	9904	IlvB	Thiamine pyrophosphate-requiring enzymes	RF00230 T-box
1	10	344	3115	96	22	13174	COG3859	Predicted membrane protein	RF00059 THI
2	77	1284	2376	112	6	11125	MethH	Methionine synthase I specific DNA methylase	RF00162 S_box
3	0	5	2327	30	26	9991	COG0116	Predicted N6-adenine-specific DNA methylase	RF00011 RNaseP_bact_b
4	6	66	2228	49	18	4383	DHBP	3,4-dihydroxy-2-butanone 4-phosphate synthase	RF00050 RFN
7	145	952	1429	51	7	10390	GuaA	GMP synthase	RF00167 Purine
8	17	108	1322	29	13	10732	GcvP	Glycine cleavage system protein P	RF00504 Glycine
9	37	749	1235	28	7	24631	DUF149	Uncharacterised BCR, YbaB family COG0718	RF00169 SRP_bact
10	123	1358	1222	36	6	10986	CbiB	Cobalamin biosynthesis protein CobD/CbiB	RF00174 Cobalamin
20	137	1133	899	32	7	9895	LysA	Diaminopimelate decarboxylase	RF00168 Lysine
21	36	141	896	22	10	10727	TerC	Membrane protein TerC	RF00080 yybP-ykoY
39	202	684	664	25	5	11945	MgtE	Mg/Co/Ni transporter MgtE	RF00380 ykoK
40	26	74	645	19	18	10323	GlmS	Glucosamine 6-phosphate synthetase	RF00234 glmS
53	208	192	561	21	5	10892	OpuBB	ABC-type proline/glycine betaine transport systems	RF00005 tRNA ¹
122	99	239	413	10	7	11784	EmrE	Membrane transporters of cations and cationic drug	RF00442 ykkC-yxkD
255	392	281	268	8	6	10272	COG0398	Uncharacterized conserved protein	RF00023 tmRNA

Table 1: Motifs that correspond to Rfam families. “Rank”: the three columns show ranks for refined motif clusters after genome scans (“RAV”), CMfinder motifs before genome scans (“CMF”), and FootPrinter results (“FP”). We used the same ranking scheme for RAV and CMF. “Score”

Rfam		Membership			Overlap			Structure		
		#	Sn	Sp	nt	Sn	Sp	bp	Sn	Sp
RF00174	Cobalamin	183	0.74 ¹	0.97	152	0.75	0.85	20	0.60	0.77
RF00504	Glycine	92	0.56 ¹	0.96	94	0.94	0.68	17	0.84	0.82
RF00234	glmS	34	0.92	1.00	100	0.54	1.00	27	0.96	0.97
RF00168	Lysine	80	0.82	0.98	111	0.61	0.68	26	0.76	0.87
RF00167	Purine	86	0.86	0.93	83	0.83	0.55	17	0.90	0.95
RF00050	RFN	133	0.98	0.99	139	0.96	1.00	12	0.66	0.65
RF00011	RNaseP_bact_b	144	0.99	0.99	194	0.53	1.00	38	0.72	0.78
RF00162	S_box	208	0.95	0.97	110	1.00	0.69	23	0.91	0.78
RF00169	SRP_bact	177	0.92	0.95	99	1.00	0.65	25	0.89	0.81
RF00230	T-box	453	0.96	0.61	187	0.77	1.00	5	0.32	0.38
RF00059	THI	326	0.89	1.00	99	0.91	0.69	13	0.56	0.74
RF00442	ykkC-yxkD	19	0.90	0.53	99	0.94	0.81	18	0.94	0.68
RF00380	ykoK	49	0.92	1.00	125	0.75	1.00	27	0.80	0.95
RF00080	yybP-ykoY	41	0.32	0.89	100	0.78	0.90	18	0.63	0.66
mean		145	0.84	0.91	121	0.81	0.82	21	0.75	0.77
median		113	0.91	0.97	105	0.81	0.83	19	0.78	0.78

Tbl 2: Prediction accuracy compared to prokaryotic subset of Rfam full alignments.

Membership: # of seqs in overlap between our predictions and Rfam's, the sensitivity (Sn) and specificity (Sp) of our membership predictions. Overlap: the avg len of overlap between our predictions and Rfam's (nt), the fractional lengths of the overlapped region in Rfam's predictions (Sn) and in ours (Sp). Structure: the avg # of correctly predicted canonical base pairs (in overlapped regions) in the secondary structure (bp), and sensitivity and specificity of our predictions. ¹After 2nd RaveNnA scan, membership Sn of Glycine, Cobalamin increased to 76% and 98% resp., Glycine Sp unchanged, but Cobalamin Sp dropped to 84%.

Example: Ribosomal Autoregulation: Excess L19 represses L19 (RF00556; 555-559 similar)

A L19 (*rplS*) mRNA leader

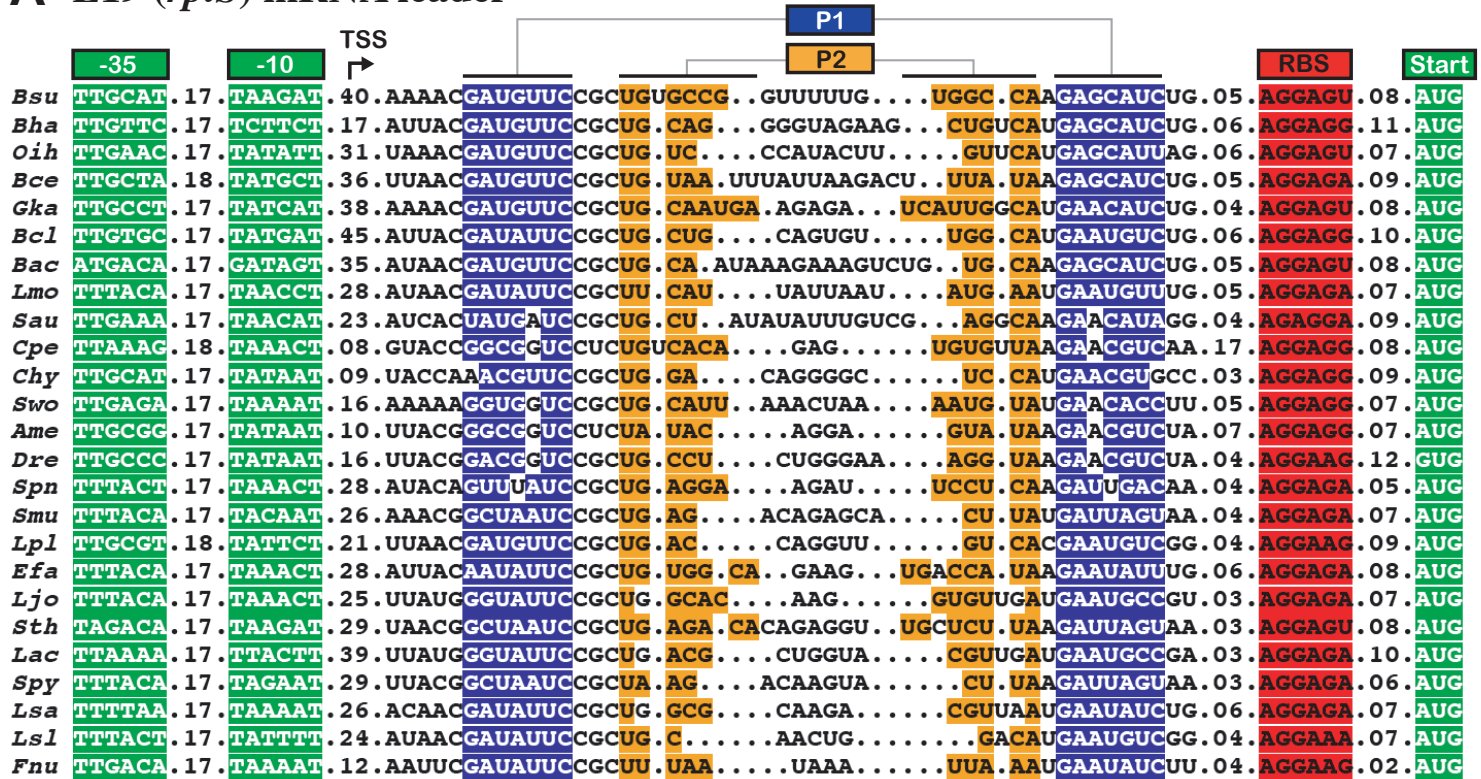

B

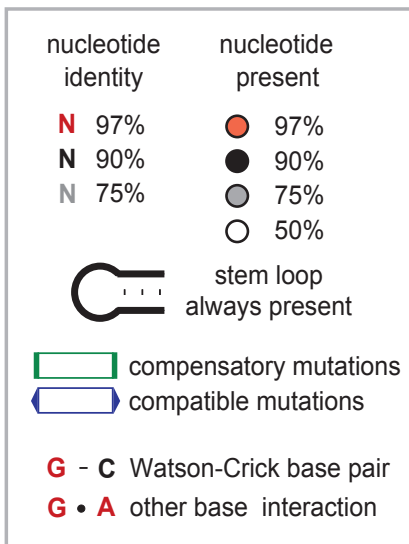
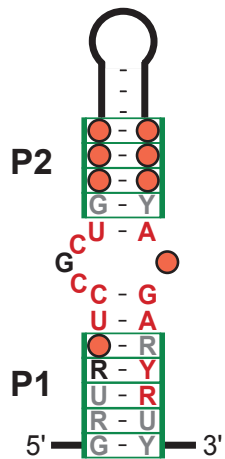

C

B. subtilis L19 mRNA leader

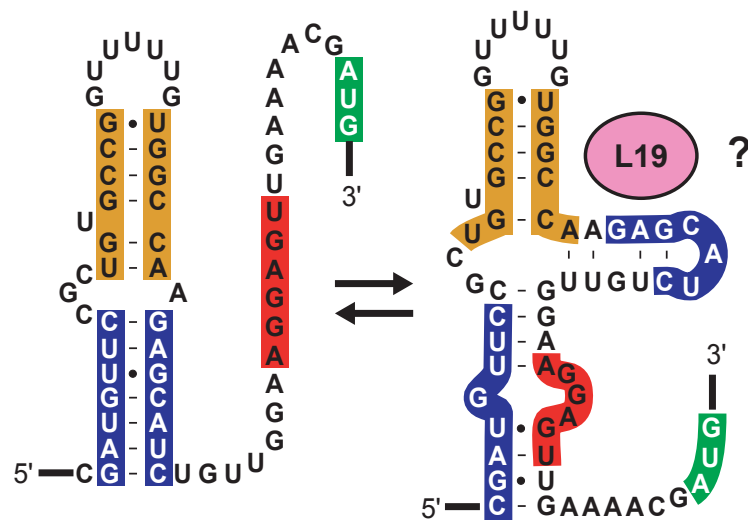

Examples: 6 (of 22) Representative motifs

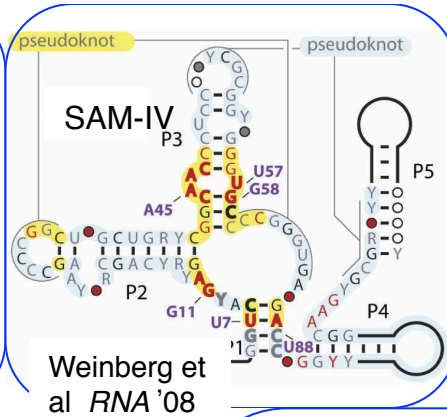
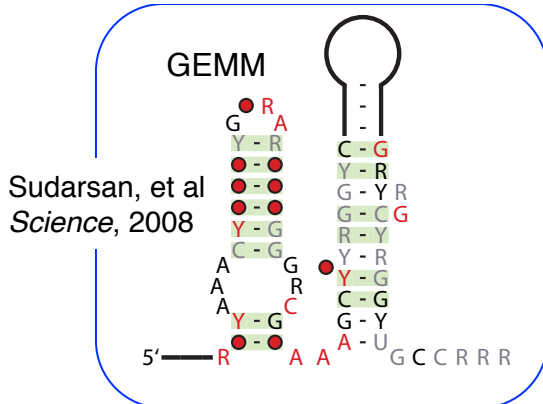

Legend

nt: nucleotides, SD: Shine-Dalgarno start: start codon, R: A/G, Y: C/U

nucleotide identity

- N 97%
- N 90%
- N 75%

nucleotide present

- 97%
- 90%
- 75%
- 50%

base pair annotations

- has covarying mutations
- has compatible mutations
- no mutations observed

nucleotide annotations

- variable hairpin
- variable loop
- modular structure

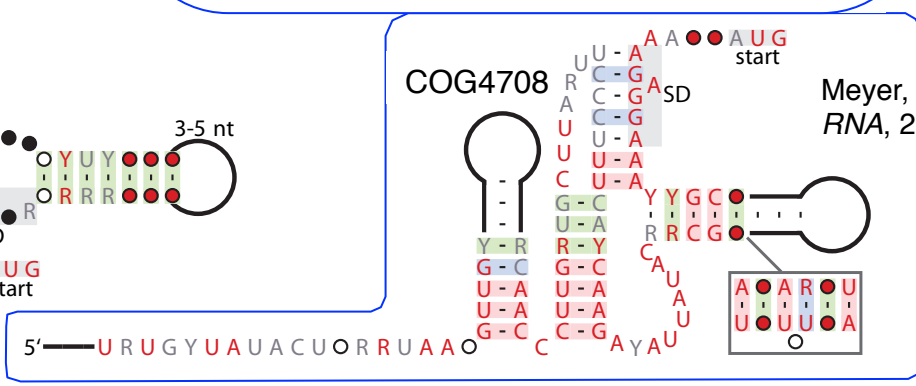
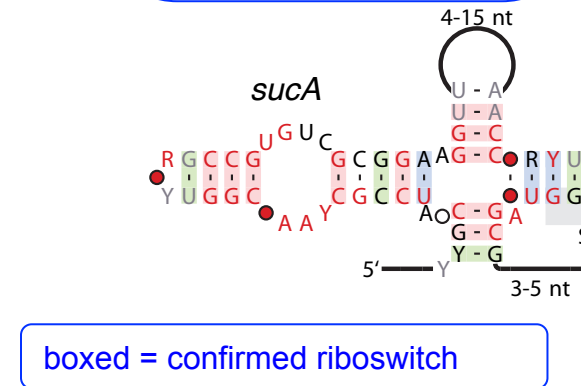
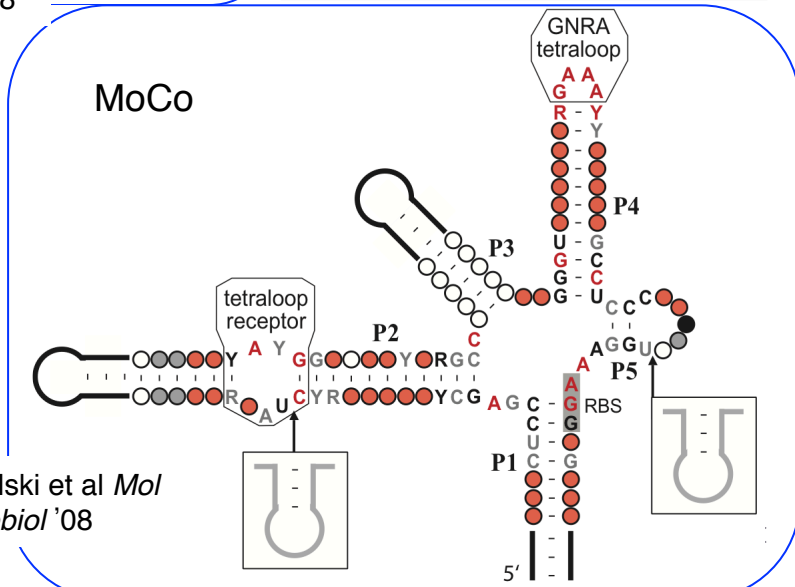
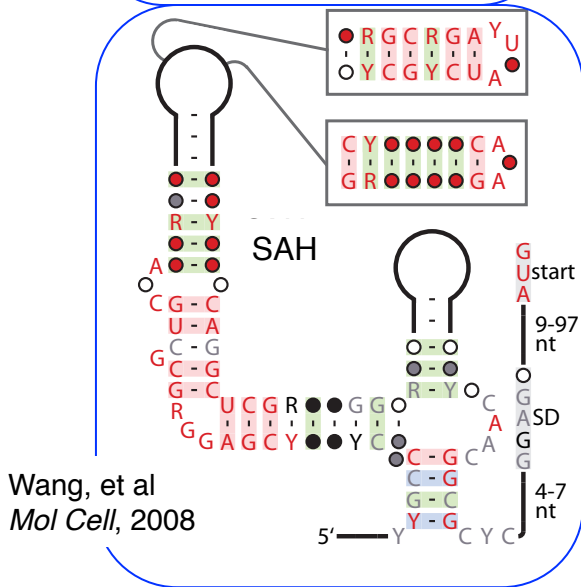

Vertebrate ncRNAs

Some Results

Human Predictions

EvoFold

S Pedersen, G Bejerano, A Siepel, K Rosenbloom, K Lindblad-Toh, ES Lander, J Kent, W Miller, D Haussler, "Identification and classification of conserved RNA secondary structures in the human genome."

[PLoS Comput. Biol., 2, #4 \(2006\) e33.](#)

48,479 candidates (~70% FDR?)

RNAz

S Washietl, IL Hofacker, M Lukasser, A Huttenhofer, PF Stadler, "Mapping of conserved RNA secondary structures predicts thousands of functional noncoding RNAs in the human genome."

[Nat. Biotechnol., 23, #11 \(2005\) 1383-90.](#)

36,000 structured RNA elements

1,000 conserved across *all* vertebrates.

~1/3 in introns of known genes, ~1/6 in UTRs

~1/2 located far from any known gene

FOLDALIGN

E Torarinsson, M Sawera, JH Havgaard, M Fredholm, J Gorodkin, "Thousands of corresponding human and mouse genomic regions unalignable in primary sequence contain common RNA structure."

[Genome Res., 16, #7 \(2006\) 885-9.](#)

1800 candidates from 36970 (of 100,000) pairs

CMfinder

Torarinsson, Yao, Wiklund, Bramsen, Hansen, Kjems, Tommerup, Ruzzo and Gorodkin. Comparative genomics beyond sequence based alignments: RNA structures in the ENCODE regions.

[Genome Research, Feb 2008, 18\(2\):242-251 PMID: 18096747](#)

6500 candidates in ENCODE alone (better FDR, but still high)

Some details below

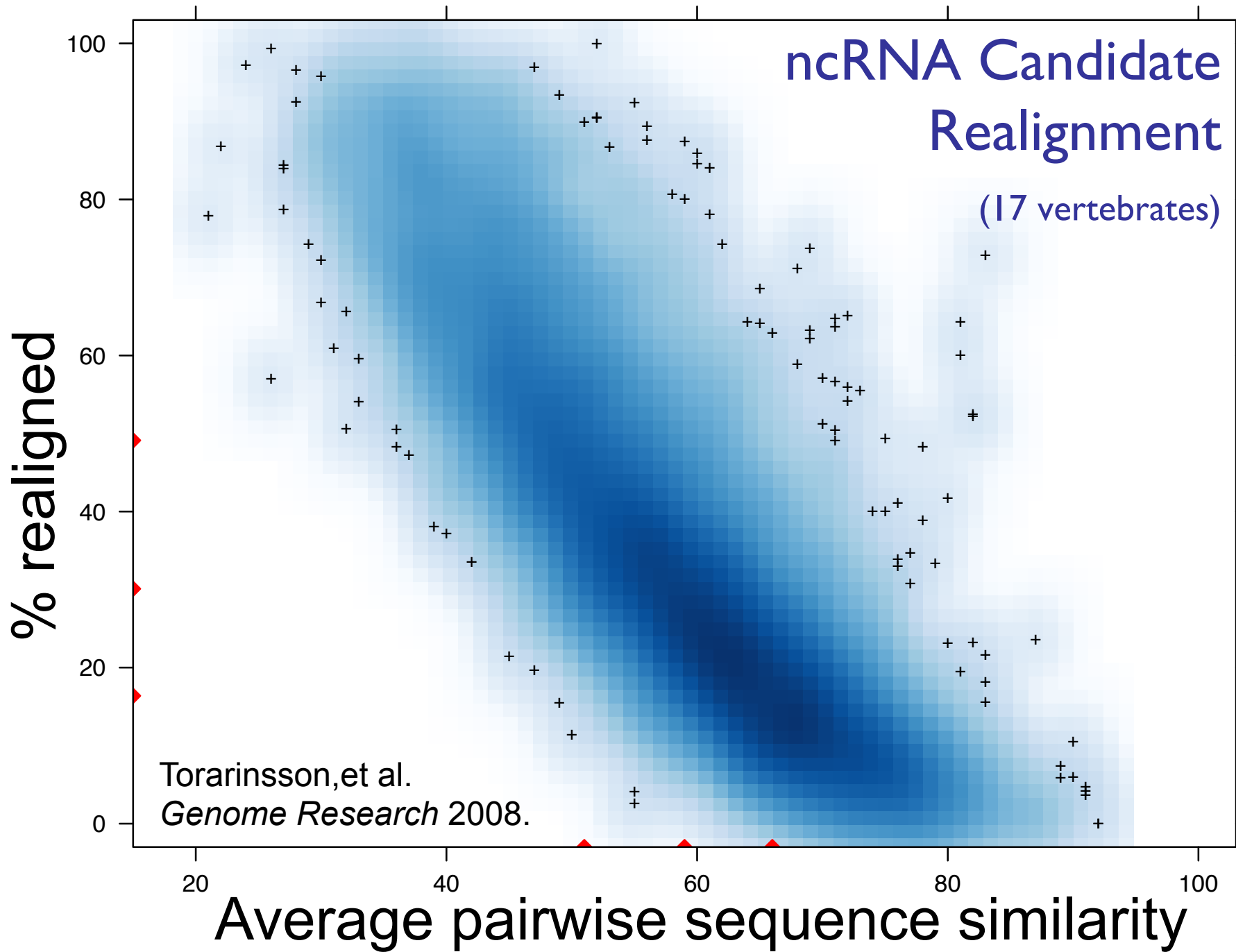

Summary

After careful control of FDR,
Widespread structured RNA prediction
Evidence for conservation
Evidence for expression
Evidence for elevated expression of
structured vs non-structured in CDS
contexts
Hypothesis: cis-regulatory roles at these loci

ncRNA Summary

ncRNA is a “hot” topic

For family homology modeling: CMs

Training & search like HMM (but slower)

Dramatic acceleration possible

Automated model construction possible

New computational methods yield new discoveries

Many open problems

CSE 427

Computational Biology

Course Wrap Up

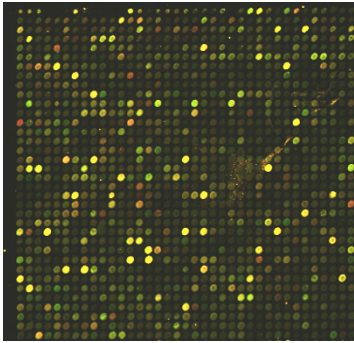

“High-Throughput BioTech”

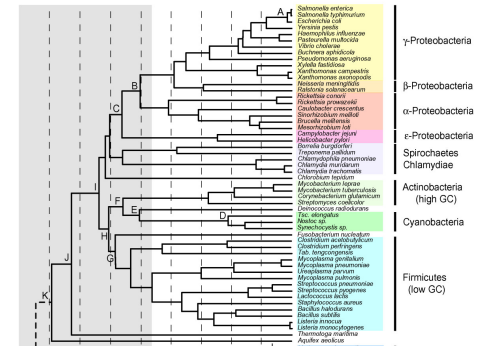

Sensors

- DNA sequencing
- Microarrays/Gene expression
- Mass Spectrometry/Proteomics
- Protein/protein & DNA/protein interaction

Controls

- Cloning
- Gene editing/knock out/knock in
- RNAi

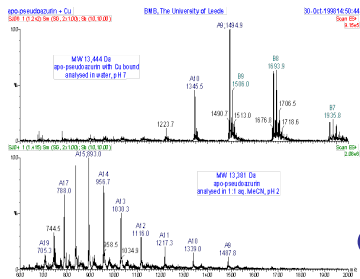
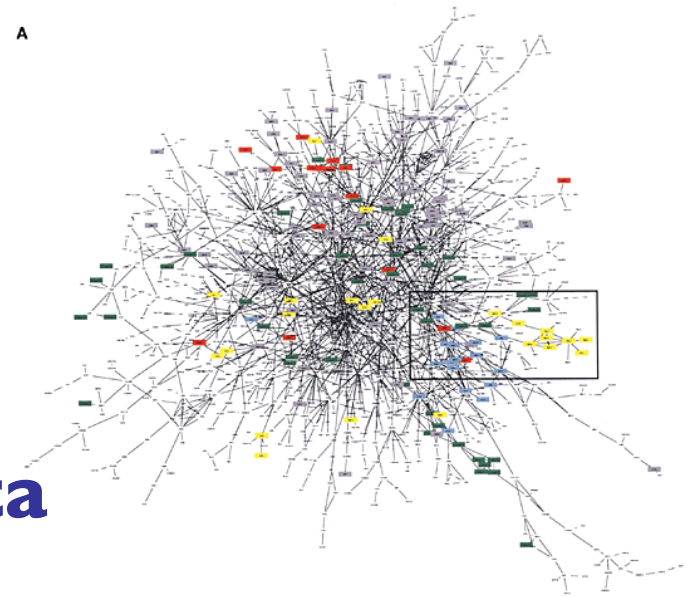
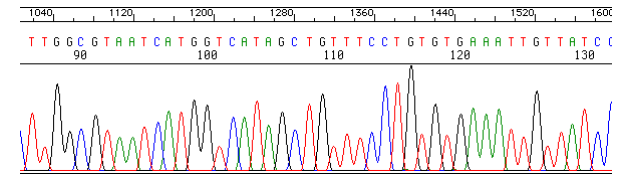
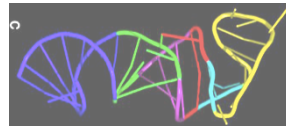

Floods of data

“Grand Challenge” problems

CS Points of Contact

Scientific visualization

- Gene expression patterns

Databases

- Integration of disparate, overlapping data sources

- Distributed genome annotation in face of shifting underlying coordinates

AI/NLP/Text Mining

- Information extraction from journal texts with inconsistent nomenclature, indirect interactions, incomplete/inaccurate models,...

Machine learning

- System level synthesis of cell behavior from low-level heterogeneous data (DNA sequence, gene expression, protein interaction, mass spec, ...)

Algorithms

...

Frontiers & Opportunities

New data:

Proteomics, SNP, arrays, CGH, comparative sequence information, epigenomics, chromatin structure, ncRNA, interactome, single-cell everything

New methods:

graphical models, rigorous filtering

Data integration

many, complex, noisy sources

Systems Biology

Frontiers & Opportunities

Open Problems:

- splicing, alternative splicing
- multiple sequence alignment (genome scale, w/ RNA etc.)
- protein & RNA structure
- interaction modeling
- regulation, at all levels
- network models
- RNA trafficking
- ncRNA discovery
- ...

Exciting Times

“Biology is to 21st Century
as Physics was to 20th”

Lots to do

Highly multidisciplinary

You'll be hearing a lot more about it

I hope I've given you a taste of it

Thanks!

PS: Please complete online course
evaluation by Sunday

<https://uw.iasystem.org/survey/151683>