

## 8. Projections

1

## Reading

Required:

- ♦ Watt, Section 5.2.2 – 5.2.4.

Further reading:

- ♦ Foley, et al, Chapter 5.6 and Chapter 6
- ♦ David F. Rogers and J. Alan Adams, *Mathematical Elements for Computer Graphics*, 2<sup>nd</sup> Ed., McGraw-Hill, New York, 1990, Chapter 2.

2

## 3D Geometry Pipeline

Before being turned into pixels, a piece of geometry goes through a number of transformations...

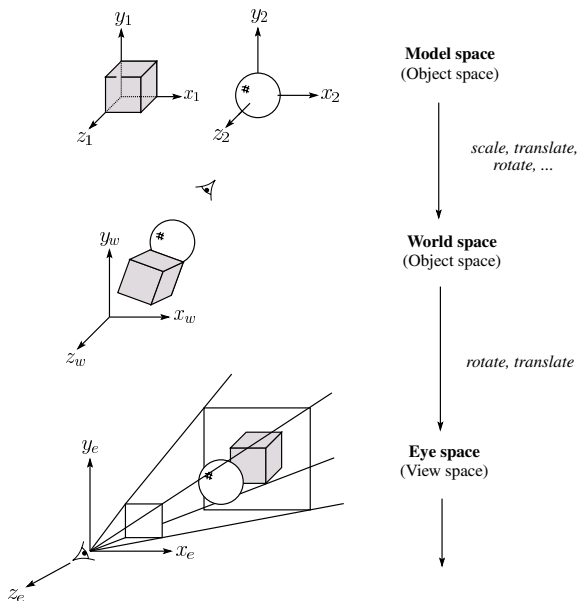

3

## 3D Geometry Pipeline (cont'd)

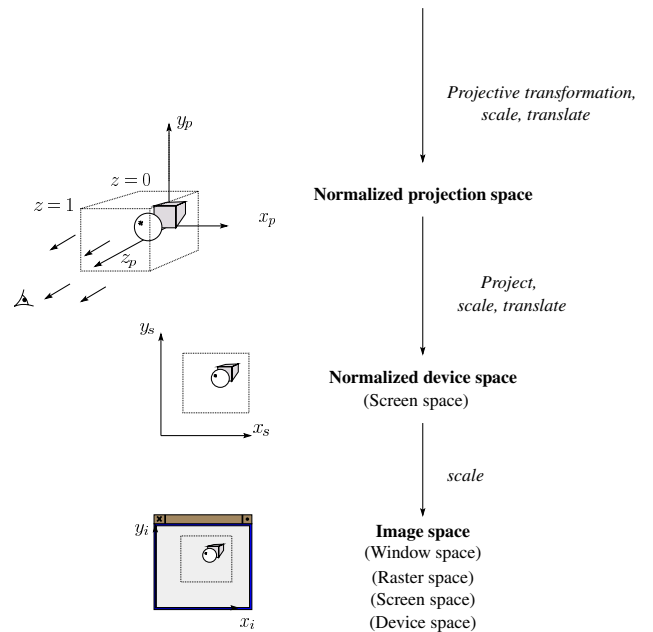

4

## Projections

**Projections** transform points in  $n$ -space to  $m$ -space, where  $m < n$ .

In 3-D, we map points from 3-space to the **projection plane** (PP) along **projectors** emanating from the **center of projection** (COP):

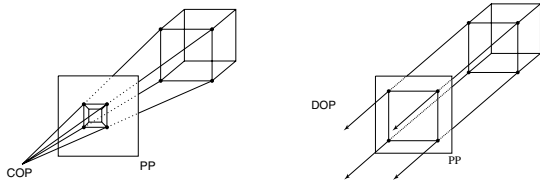

The center of projection is exactly the same as the pinhole in a pinhole camera.

There are two basic types of projections:

- ◆ Perspective – distance from COP to PP finite
- ◆ Parallel – distance from COP to PP infinite

5

## Parallel projections

For parallel projections, we specify a **direction of projection** (DOP) instead of a COP.

There are two types of parallel projections:

- ◆ **Orthographic projection** – DOP perpendicular to PP
- ◆ **Oblique projection** – DOP not perpendicular to PP

We can write orthographic projection onto the  $z=0$  plane with a simple matrix.

$$\begin{bmatrix} x' \\ y' \\ 1 \end{bmatrix} = \begin{bmatrix} 1 & 0 & 0 & 0 \\ 0 & 1 & 0 & 0 \\ 0 & 0 & 0 & 1 \end{bmatrix} \begin{bmatrix} x \\ y \\ z \\ 1 \end{bmatrix}$$

Normally, we do not drop the  $z$  value right away. Why not?

6

## Oblique parallel projections

There are two standard kinds of oblique projections:

- ◆ **Cavalier projection**
  - DOP makes 45 degree angle with PP
  - Does not foreshorten lines perpendicular to PP
- ◆ **Cabinet projection**
  - DOP makes a 63.4 degree angle with PP
  - Foreshortens lines perpendicular to PP by one-half

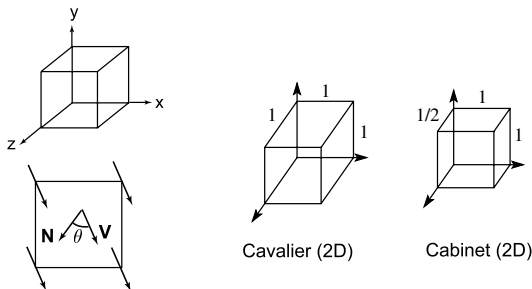

Oblique projection geometry (3D)

7

## Properties of parallel projection

Properties of parallel projection:

- ◆ Not realistic looking
- ◆ Good for exact measurements
- ◆ Are actually a kind of affine transformation
  - Parallel lines remain parallel
  - Angles not (in general) preserved
- ◆ Most often used in CAD, architectural drawings, etc., where taking exact measurement is important

8

## Derivation of perspective projection

Consider the projection of a point onto the projection plane:

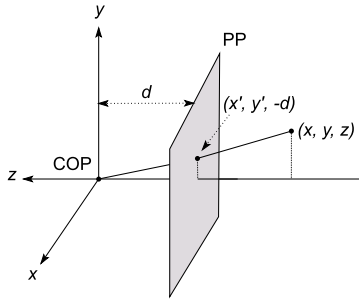

By similar triangles, we can compute how much the x and y coordinates are scaled:

[Note: Watt uses a left-handed coordinate system, and he looks down the +z axis, so his PP is at +d.]

9

## Homogeneous coordinates revisited

Remember how we said that affine transformations work with the last coordinate always set to one.

What happens if the coordinate is not one?

We divide all the coordinates by w:

$$\begin{bmatrix} x \\ y \\ z \\ w \end{bmatrix} \rightarrow \begin{bmatrix} x/w \\ y/w \\ z/w \\ 1 \end{bmatrix}$$

If  $w = 1$ , then nothing changes.

Sometimes we call this division step the "perspective divide."

10

## Homogeneous coordinates and perspective projection

Now we can re-write the perspective projection as a matrix equation:

$$\begin{bmatrix} x' \\ y' \\ w' \end{bmatrix} = \begin{bmatrix} 1 & 0 & 0 & 0 \\ 0 & 1 & 0 & 0 \\ 0 & 0 & -1/d & 0 \end{bmatrix} \begin{bmatrix} x \\ y \\ z \\ w \end{bmatrix} = \begin{bmatrix} x \\ y \\ -z/d \end{bmatrix}$$

After division by w, we get:

$$\begin{bmatrix} x' \\ y' \\ 1 \end{bmatrix} = \begin{bmatrix} -x/d \\ -y/d \\ z \end{bmatrix}$$

Again, projection implies dropping the z coordinate to give a 2D image, but we usually keep it around a little while longer.

11

## Projective normalization

After applying the perspective transformation and dividing by w, we are free to do a simple parallel projection to get the 2D image.

What does this imply about the shape of things after the perspective transformation + divide?

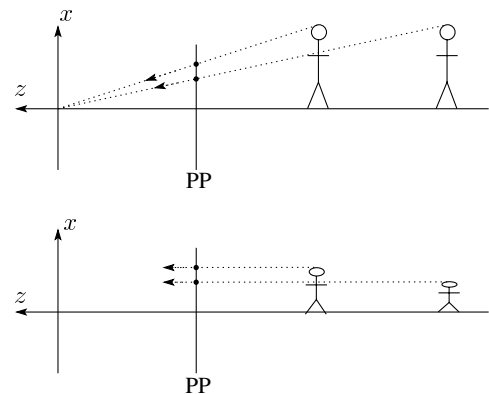

12

## Vanishing points

What happens to two parallel lines that are not parallel to the projection plane?

Think of train tracks receding into the horizon...

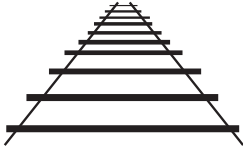

The equation for a line is:

$$\mathbf{l} = \mathbf{p} + t\mathbf{v} = \begin{bmatrix} p_x \\ p_y \\ p_z \\ 1 \end{bmatrix} + t \begin{bmatrix} v_x \\ v_y \\ v_z \\ 0 \end{bmatrix}$$

After perspective transformation we get:

$$\begin{bmatrix} x' \\ y' \\ w' \end{bmatrix} = \begin{bmatrix} p_x + tv_x \\ p_y + tv_y \\ -(p_z + tv_z)/d \end{bmatrix}$$

13

## Vanishing points (cont'd)

Dividing by  $w$ :

$$\begin{bmatrix} x' \\ y' \\ w' \end{bmatrix} = \begin{bmatrix} \frac{p_x + tv_x}{p_z + tv_z} d \\ \frac{p_y + tv_y}{p_z + tv_z} d \\ 1 \end{bmatrix}$$

Letting  $t$  go to infinity:

We get a point!

What happens to the line  $\mathbf{l} = \mathbf{q} + t\mathbf{v}$ ?

Each set of parallel lines intersect at a **vanishing point** on the PP.

**Q:** How many vanishing points are there?

14

## Principal vanishing points

If we define a set of **principal axes** in world coordinates, i.e., the  $x_w$ ,  $y_w$ , and  $z_w$  axes, then it's possible to choose the viewpoint such that these axes will converge to different vanishing points.

The vanishing points of the principal axes are called the **principal vanishing points**. Example:

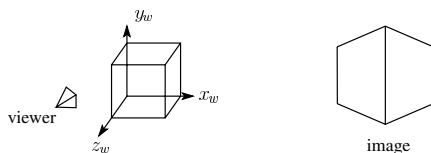

Perspective drawings are often classified by the number of principal vanishing points.

- One-point perspective – simplest to draw
- Two-point perspective – gives better impression of depth
- Three-point perspective – most difficult to draw

All three types are equally simple with computer graphics.

15

## Clipping and the viewing frustum

The center of projection and the portion of the projection plane that map to the final image form an infinite pyramid. The sides of the pyramid are **clipping planes**.

Frequently, additional clipping planes are inserted to restrict the range of depths. These clipping planes are called the **near** and **far** or the **hither** and **yon** clipping planes.

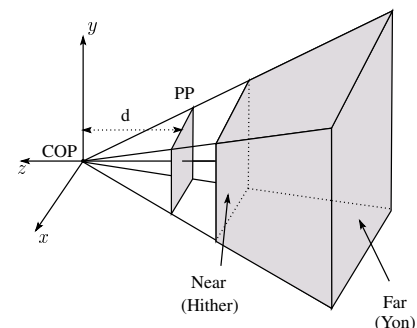

All of the clipping planes bound the the **viewing frustum**.

16

## Properties of perspective projections

The perspective projection is an example of a **projective transformation**.

Here are some properties of projective transformations:

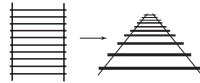

- ◆ Lines map to lines
- ◆ Parallel lines do not necessarily remain parallel
- ◆ Ratios are not preserved

One of the advantages of perspective projection is that size varies inversely with distance – looks realistic.

A disadvantage is that we can't judge distances as exactly as we can with parallel projections.

**Q:** Why did nature give us eyes that perform perspective projections?

**Q:** Do our eyes "see in 3D"?

## Summary

What to take away from this lecture:

- ◆ All the boldfaced words.
- ◆ An appreciation for the various coordinate systems used in computer graphics.
- ◆ How the perspective transformation works.
- ◆ How we use homogeneous coordinates to represent perspective projections.
- ◆ The classification of different types of projections.
- ◆ The concepts of vanishing points and one-, two-, and three-point perspective.
- ◆ The mathematical properties of projective transformations.