

## CSE 461: Transport Layer Connections

### Naming Processes/Services

- Process here is an abstract term for your Web browser (HTTP), Email servers (SMTP), hostname translation (DNS), RealAudio player (RTSP), etc.
- How do we identify for remote communication?
  - Process id or memory address are OS-specific and transient
- So TCP and UDP use Ports
  - 16-bit integers representing mailboxes that processes "rent"
    - typically from OS
  - Identify endpoint uniquely as (IP address, protocol, port)
    - OS converts into process-specific channel, like "socket"

## Processes as Endpoints

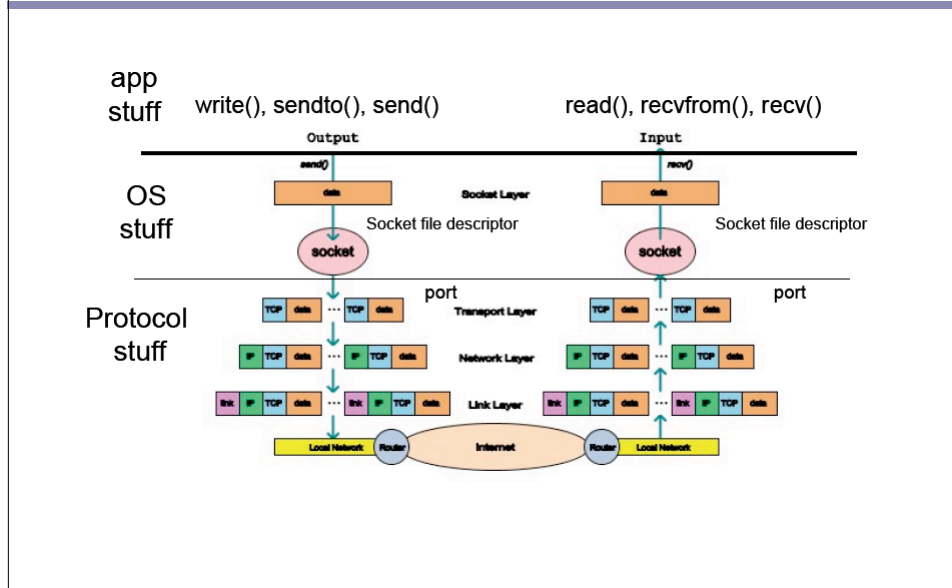

## Picking Port Numbers

- We still have the problem of allocating port numbers
  - What port should a Web server use on host X?
  - To what port should you send to contact that Web server?
- Servers typically bind to "well-known" port numbers
  - e.g., HTTP 80, SMTP 25, DNS 53, ... look in `/etc/services`
  - Ports below 1024 reserved for "well-known" services
- Clients use OS-assigned temporary (ephemeral) ports
  - Above 1024, recycled by OS when client finished

# User Datagram Protocol (UDP)

- Provides message delivery between processes
  - Source port filled in by OS as message is sent
  - Destination port identifies UDP delivery queue at endpoint

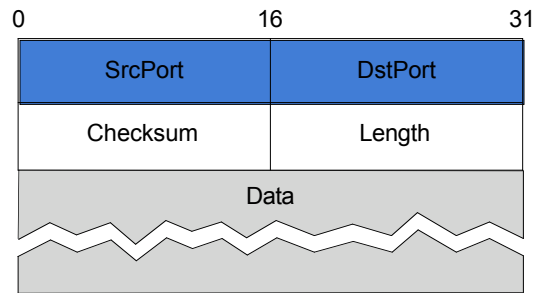

# UDP Delivery

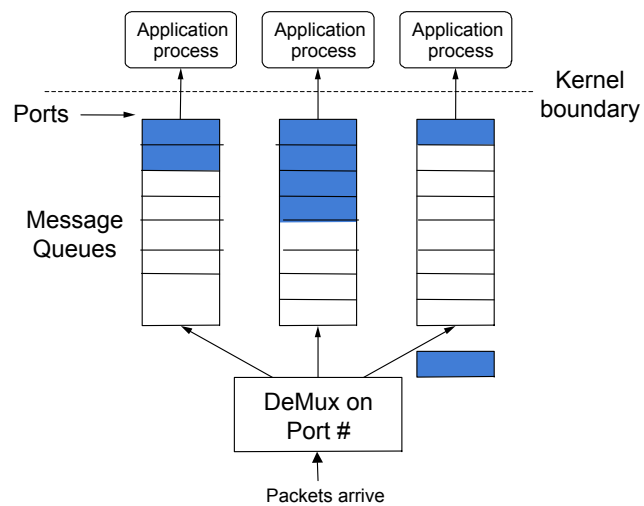

## UDP Checksum

- UDP includes optional protection against errors
  - Checksum intended as an end-to-end check on delivery
  - So it covers data, UDP header

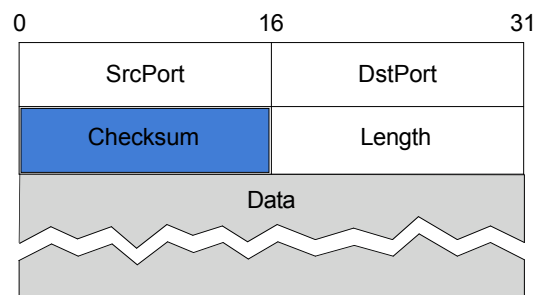

## Transmission Control Protocol (TCP)

- Reliable bi-directional bytestream between processes
  - Message boundaries are not preserved
- Connections
  - Conversation between endpoints with beginning and end
- Flow control
  - Prevents sender from over-running receiver buffers
- Congestion control
  - Prevents sender from over-running network buffers

# TCP Header Format

- Ports plus IP addresses identify a connection

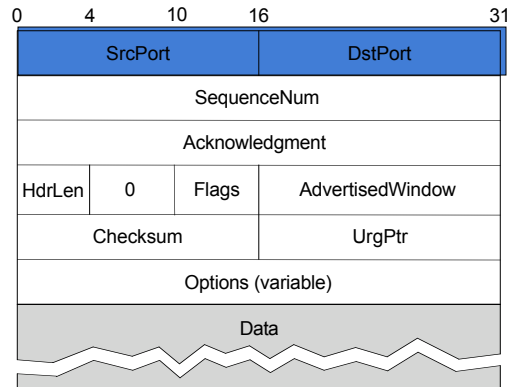

# TCP Header Format

- Sequence, Ack numbers used for the sliding window

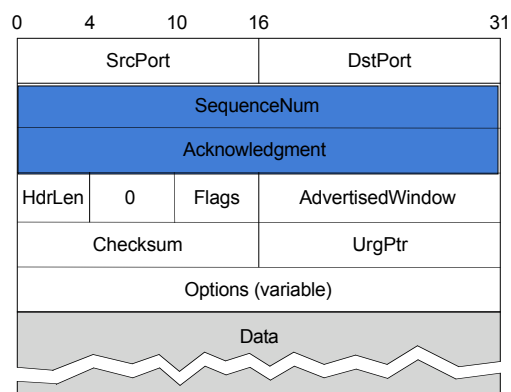

## TCP Header Format

- Flags may be URG, ACK, PUSH, RST, SYN, FIN

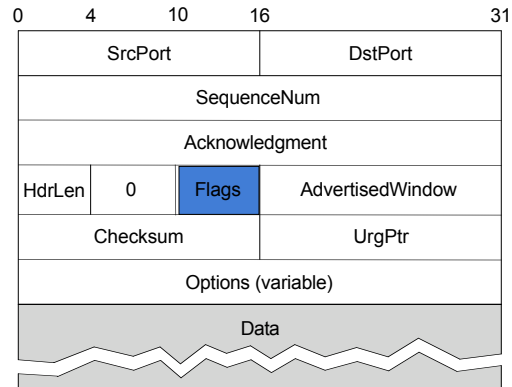

## TCP Header Format

- Advertised window is used for flow control

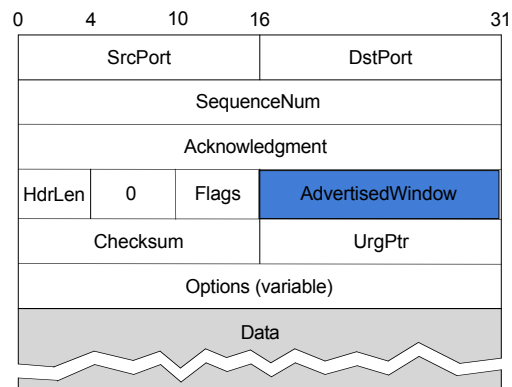

## TCP Connection Establishment

- Both connecting and closing are (slightly) more complicated than you might expect
- That they *can* work is reasonably straightforward
- Harder is what to do when things go wrong
  - TCP SYN+ACK attack
- Close looks a bit complicated because both sides have to close to be done
  - Conceptually, there are two one-way connections
  - Don't want to hang around forever if other end crashes

## Three-Way Handshake

- Opens both directions for transfer

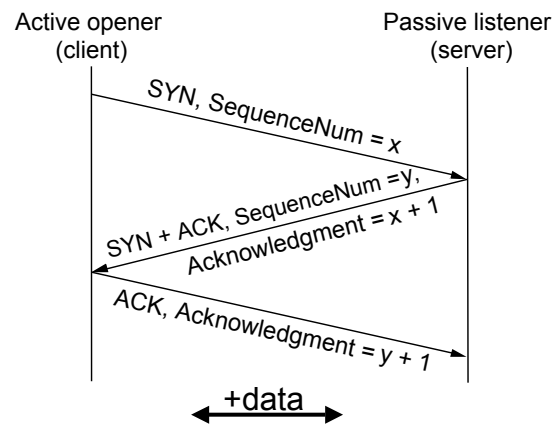

## Some Comments

- We could abbreviate this setup, but it was chosen to be robust, especially against delayed duplicates
  - Three-way handshake from Tomlinson 1975
- Choice of changing initial sequence numbers (ISNs) minimizes the chance of hosts that crash getting confused by a previous incarnation of a connection
- But with random ISN it actually proves that two hosts can communicate
  - Weak form of authentication

## TCP State Transitions

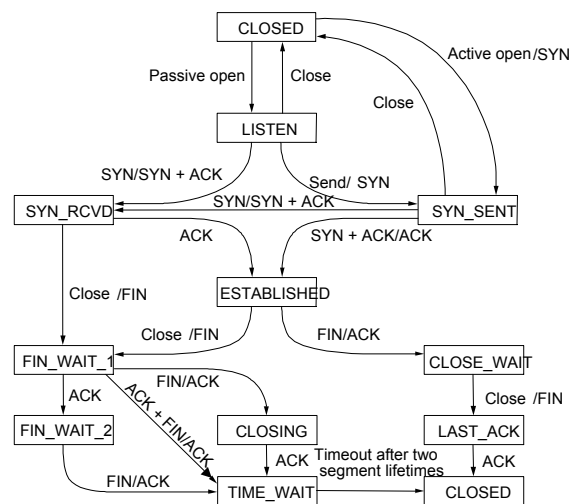



## Again, with States

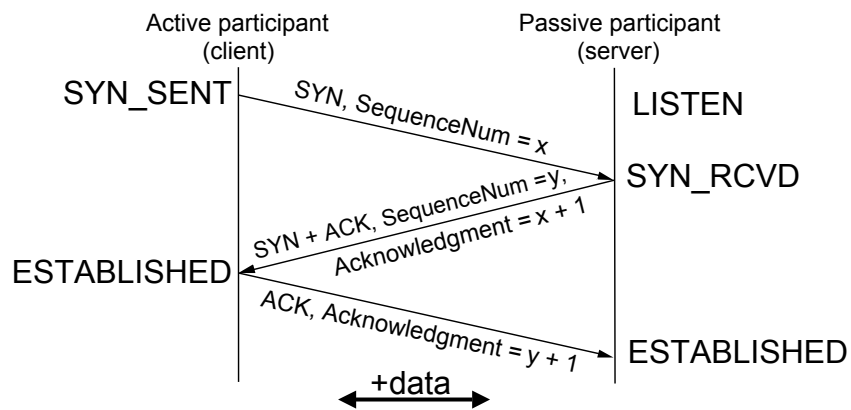

## Connection Teardown

- Orderly release by sender and receiver when done
  - Delivers all pending data and “hangs up”
- Cleans up state in sender and receiver
- TCP provides a “symmetric” close
  - both sides shutdown independently

## TCP Connection Teardown

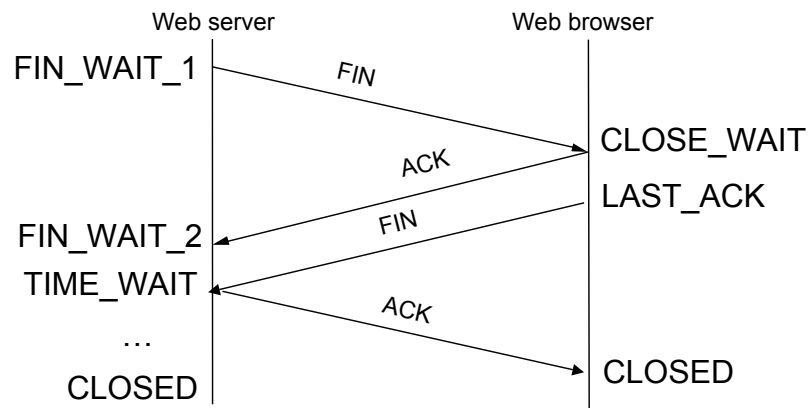

## The TIME\_WAIT State

- We wait 2MSL (two times the maximum segment lifetime of 60 seconds) before completing the close
- Why?
  - ACK might have been lost and so FIN will be resent
  - Could interfere with a subsequent connection

## Berkeley Sockets interface

- Networking protocols implemented in OS
  - OS must expose a programming API to applications
  - most OSs use the "socket" interface
  - originally provided by BSD 4.1c in ~1982.
- Principle abstraction is a "socket"
  - a point at which an application attaches to the network
  - defines operations for creating connections, attaching to network, sending and receiving data, closing connections

## TCP (connection-oriented)

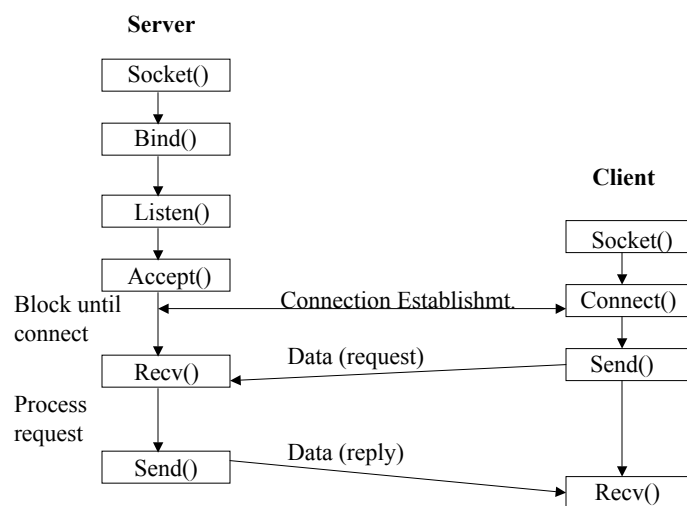

## UDP (connectionless)

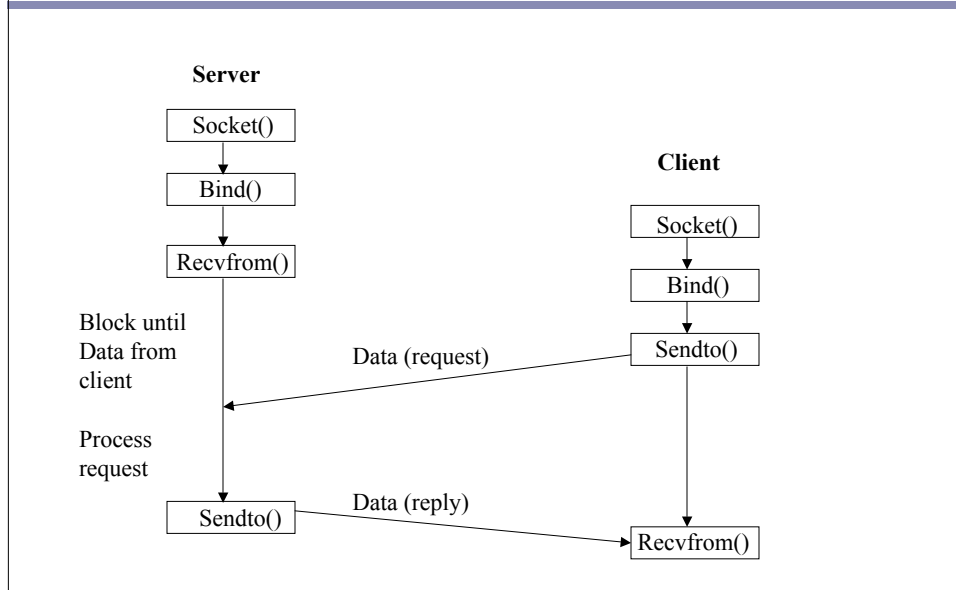

## Key Concepts

- We use ports to name processes in TCP/UDP
  - "Well-known" ports are used for popular services
- Connection setup and teardown complicated by the effects of the network on messages
  - TCP uses a three-way handshake to set up a connection
  - TCP uses a symmetric disconnect