

Network Layer

Where we are in the Course

- Moving on up to the Network Layer!

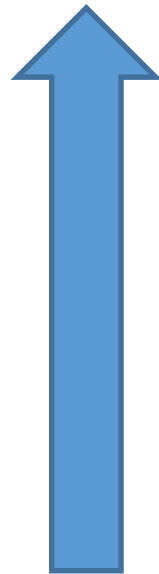
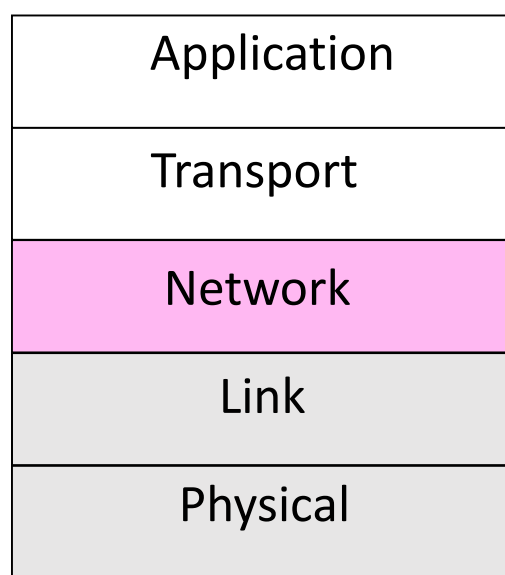

Network Layer

- How to connect different link layer networks
 - Routing as the primary concern

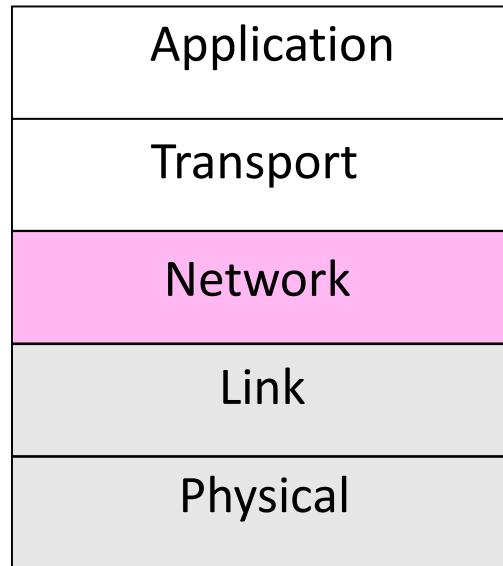

Why do we need a Network layer?

- We can already build networks with links and switches and send frames between hosts ...

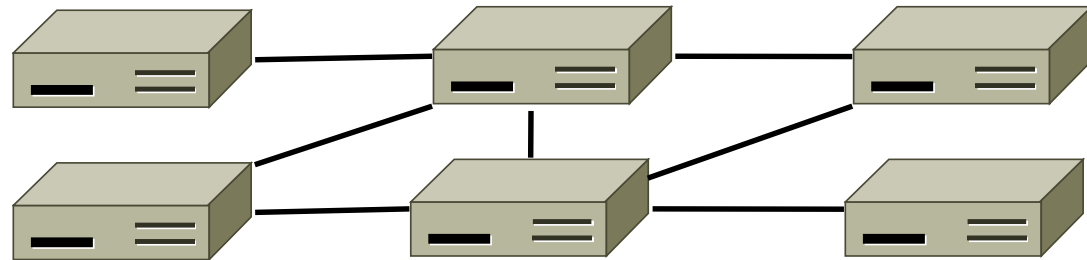

Shortcomings of Switches

1. Don't scale to large networks
 - Blow up of routing table, broadcast

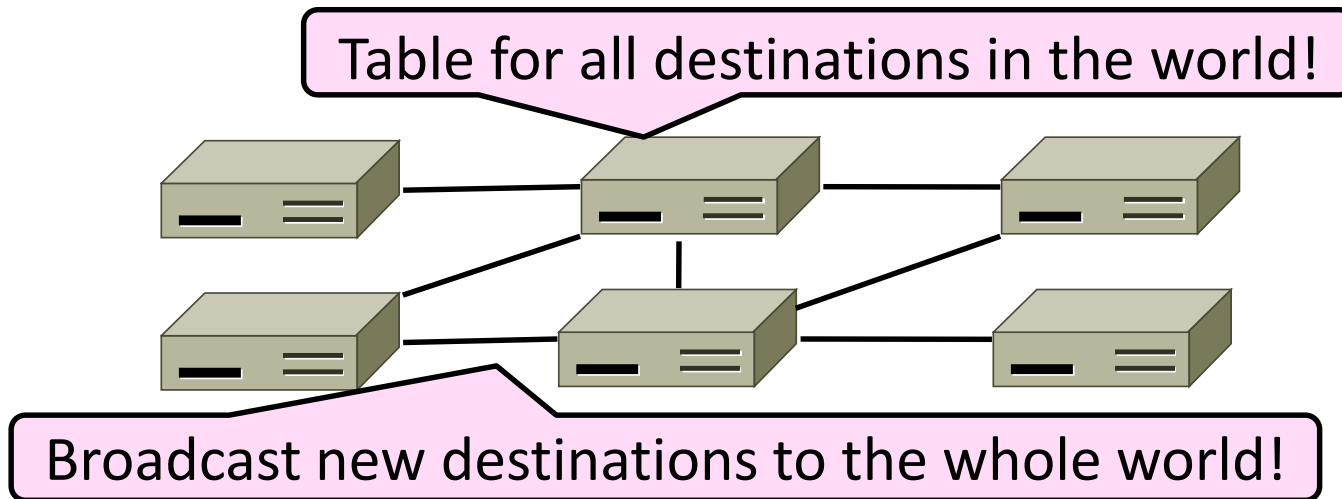

Shortcomings of Switches (2)

2. Don't work across more than one link layer technology

- Hosts on Ethernet + 3G + 802.11 ...

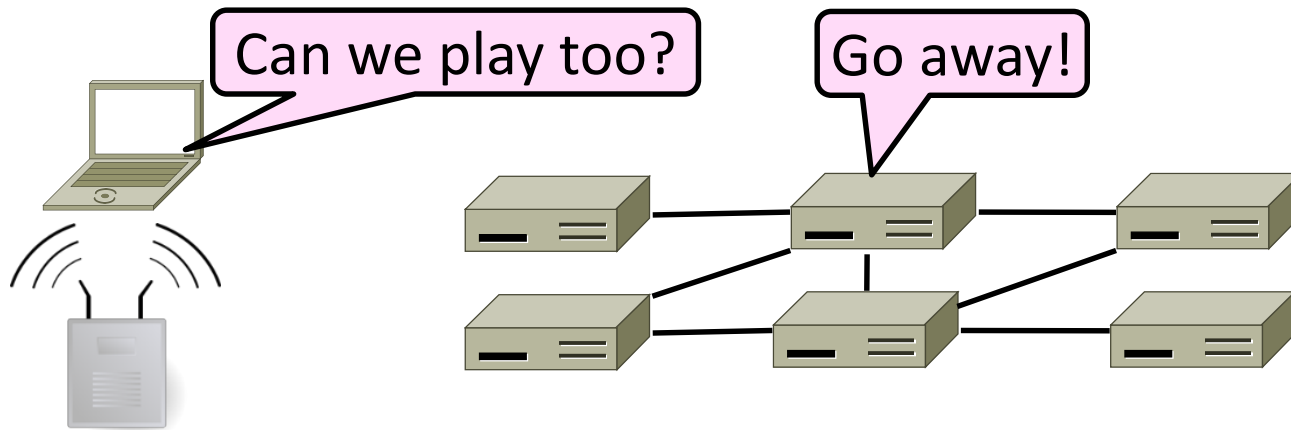

Shortcomings of Switches (3)

3. Don't give much traffic control
 - Want to plan routes / bandwidth

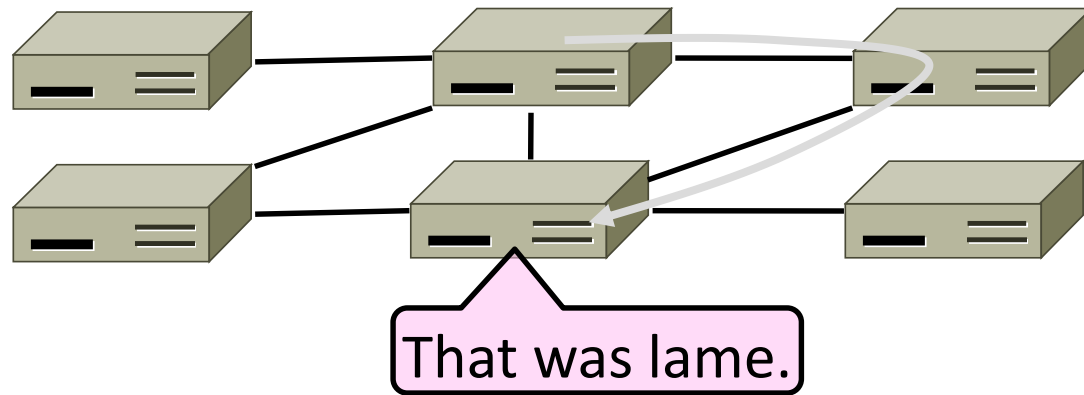

Network Layer Approach

- Scaling:
 - Hierarchy, in the form of prefixes
- Heterogeneity:
 - IP for internetworking
- Bandwidth Control:
 - Lowest-cost routing
 - Later QOS (Quality of Service)

Topics

- Network service models
 - Datagrams (packets), virtual circuits
- IP (Internet Protocol)
 - Internetworking
 - Forwarding (Longest Matching Prefix)
 - Helpers: ARP and DHCP
 - Fragmentation and MTU discovery
 - Errors: ICMP (traceroute!)
 - IPv6, scaling IP to the world
 - NAT, and “middleboxes”
- Routing Algorithms

Routing vs. Forwarding

- Routing is the process of deciding in which direction to send traffic
 - Network wide (global) and expensive

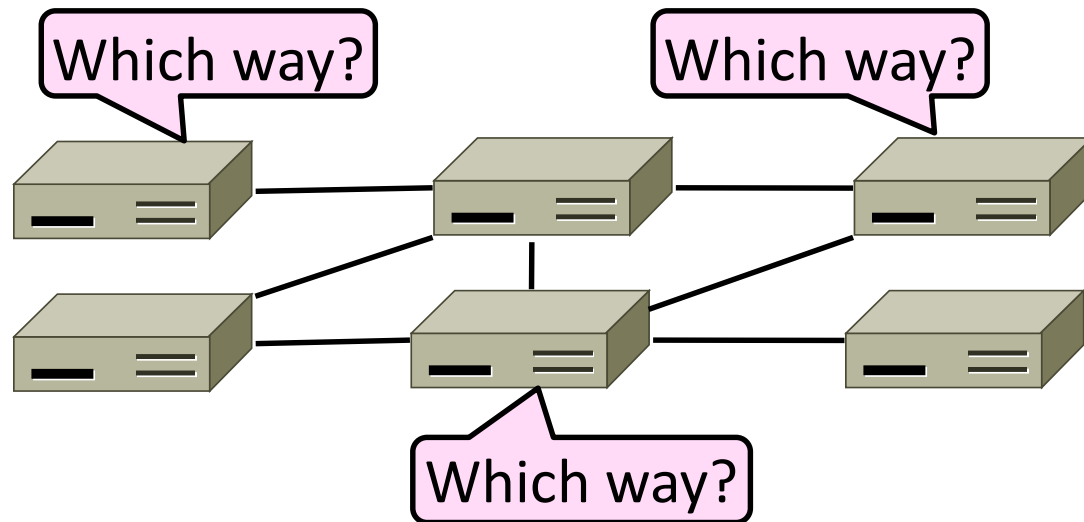

Routing vs. Forwarding (2)

- Forwarding is the process of sending a packet
 - Node process (local) and fast

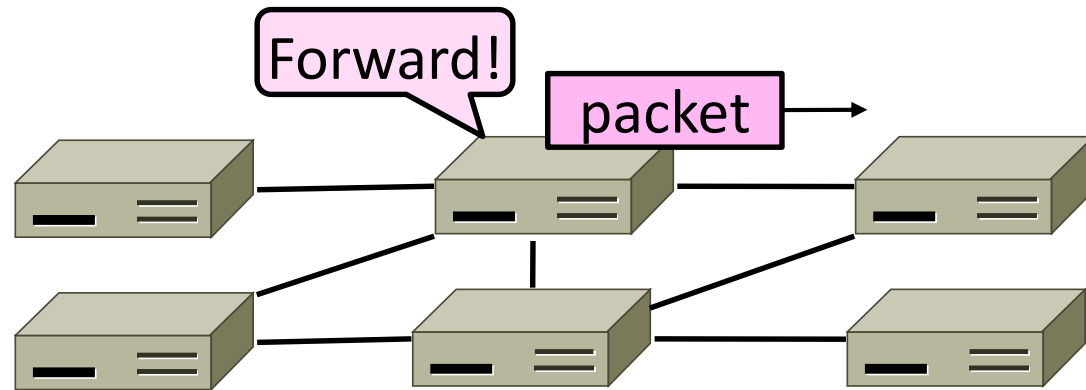

Networking Services

Topic

- What kind of service does the Network layer provide to the Transport layer?
 - How is it implemented at routers?

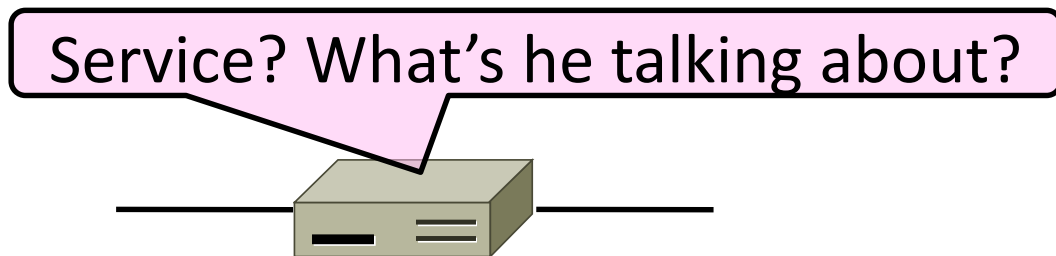

Two Network Service Models

- Datagrams, or connectionless service

- Like postal letters

- (IP as an example)



- Virtual circuits, or connection-oriented service

- Like a telephone call



Store-and-Forward Packet Switching

- Both models are implemented with store-and-forward packet switching
 - Routers receive a complete packet, storing it temporarily if necessary before forwarding it onwards
 - We use statistical multiplexing to share link bandwidth over time

Store-and-Forward (2)

- Switching element has internal buffering for contention

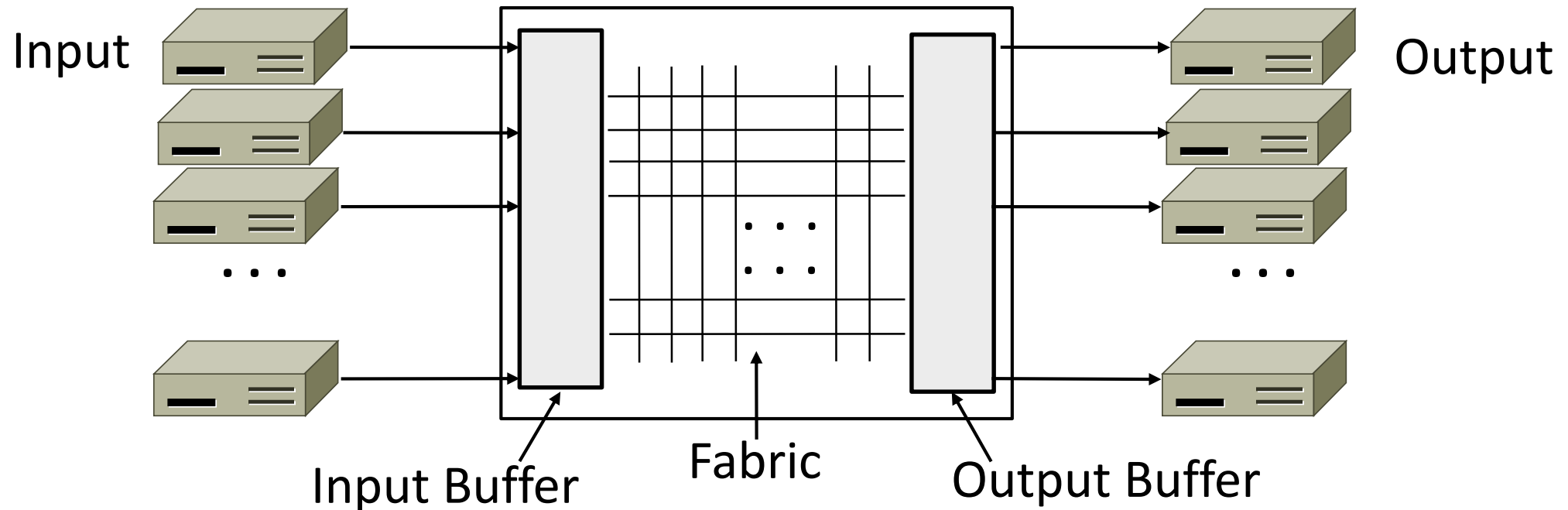

Store-and-Forward (3)

- Simplified view with per port output buffering
 - Buffer is typically a FIFO (First In First Out) queue
 - If full, packets are discarded (congestion, later)

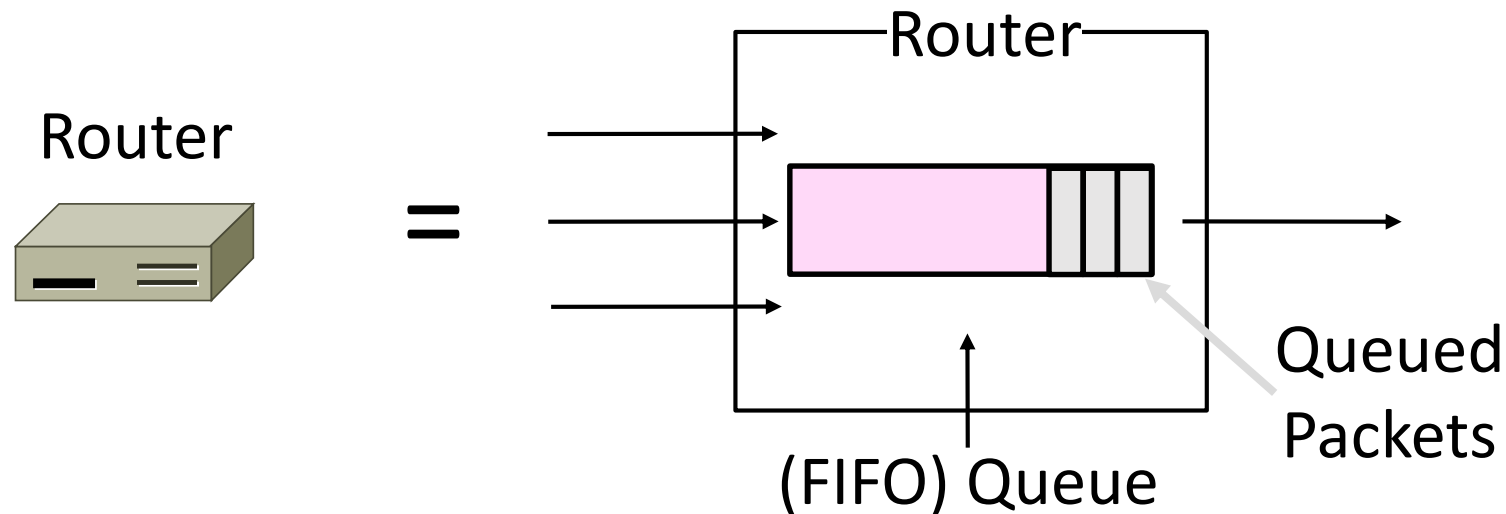

Datagram Model

- Packets contain a destination address; each router uses it to forward packets, maybe on different paths

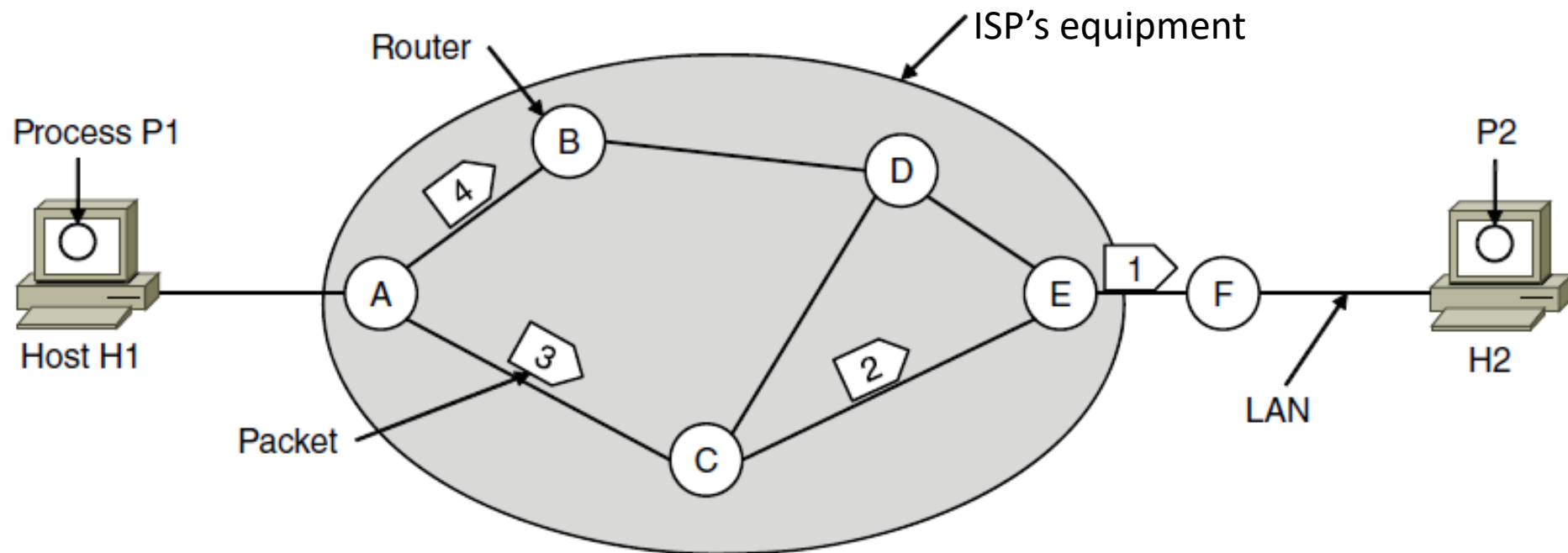

Datagram Model (2)

- Each router has a forwarding table keyed by address
 - Gives next hop for each destination address; may change

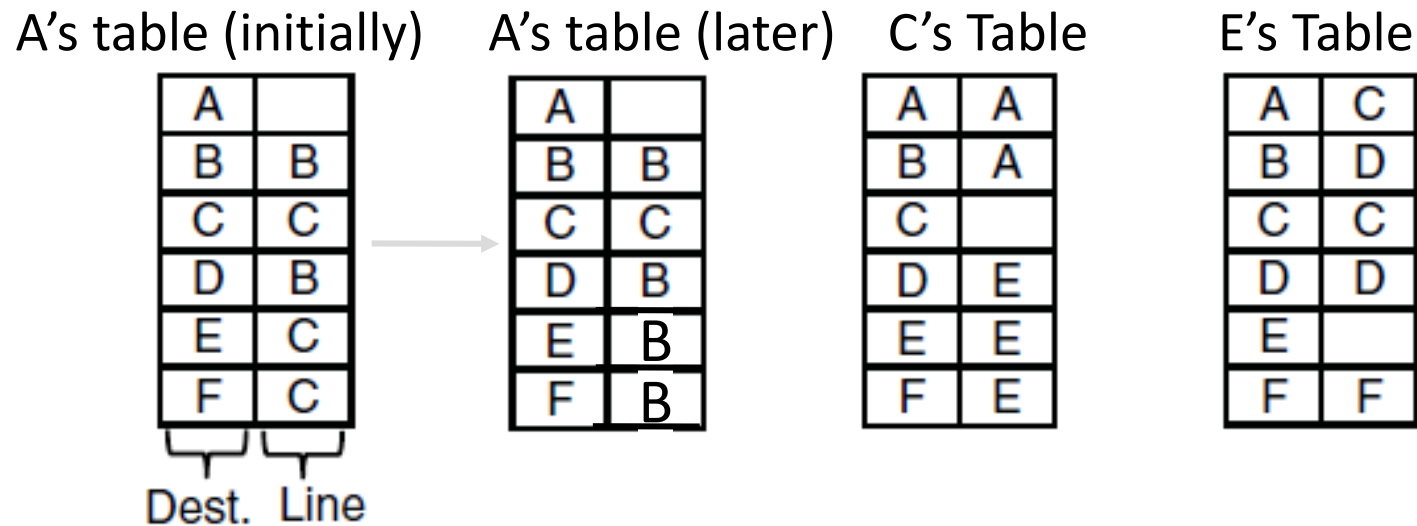

Datagrams vs Virtual Circuits

- Complementary strengths

Issue	Datagrams	Virtual Circuits
Setup phase	Not needed	Required
Router state	Per destination	Per connection
Addresses	Packet carries full address	Packet carries short label
Routing	Per packet	Per circuit
Failures	Easier to mask	Difficult to mask
Quality of service	Difficult to add	Easier to add

IP (Internet Protocol)

- Network layer of the Internet, uses datagrams (next)
 - IPv4 carries 32 bit addresses on each packet (often 1.5 KB)

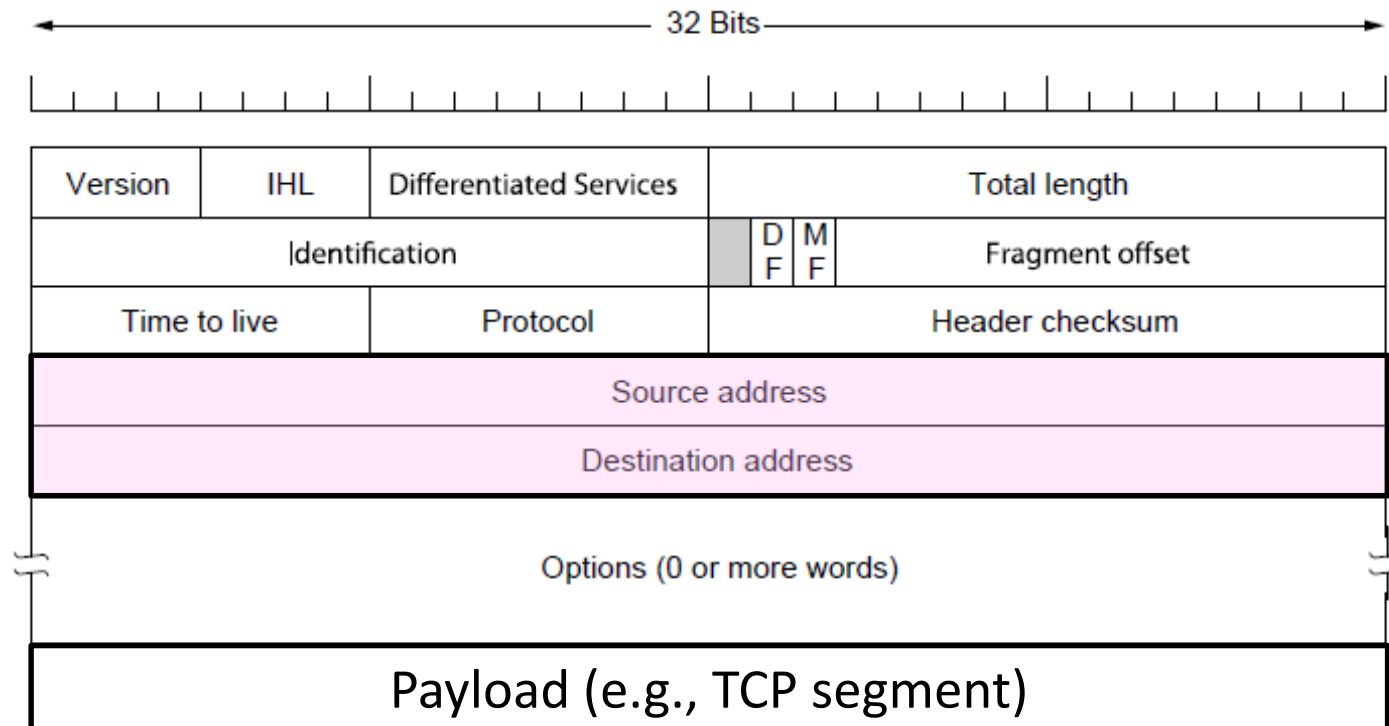

Internetworking (IP)

Topic

- How do we connect different networks together?
 - This is called internetworking
 - We'll look at how IP does it

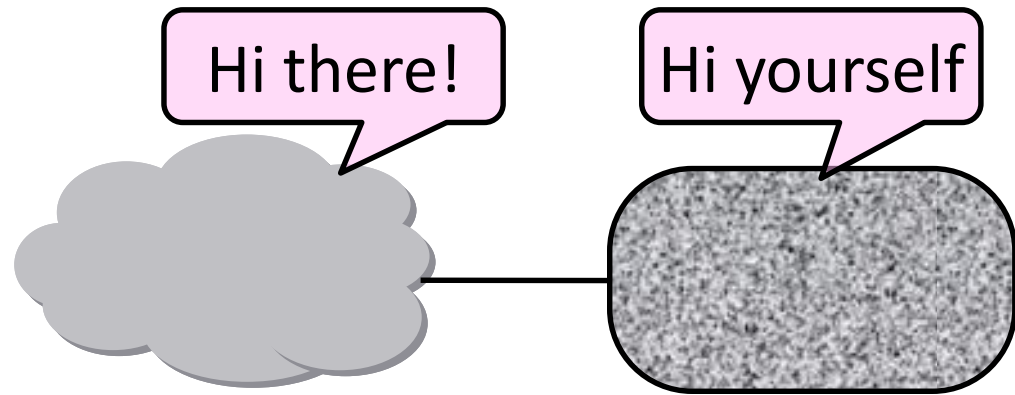

How Networks May Differ

- Basically, in a lot of ways:
 - Service model (datagrams, VCs)
 - Addressing (what kind)
 - QOS (priorities, no priorities)
 - Packet sizes
 - Security (whether encrypted)
- Internetworking hides the differences with a common protocol. (Uh oh.)

Connecting Datagram and VC networks

- An example to show that it's not so easy
 - Need to map destination address to a VC and vice-versa
 - A bit of a “road bump”, e.g., might have to set up a VC

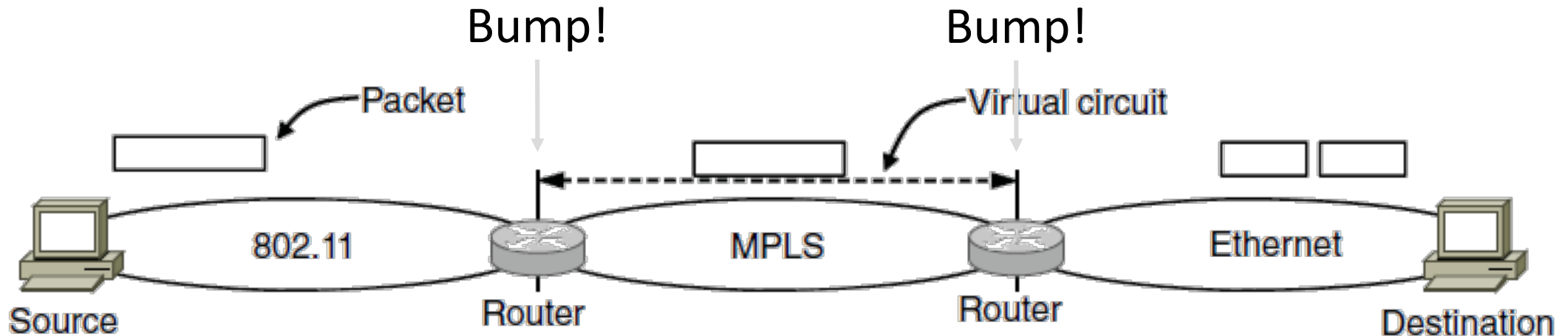

Internetworking – Cerf and Kahn

- Pioneers: Cerf and Kahn
 - “Fathers of the Internet”
 - In 1974, later led to TCP/IP
- Tackled the problems of interconnecting networks
 - Instead of mandating a single network technology

Vint Cerf

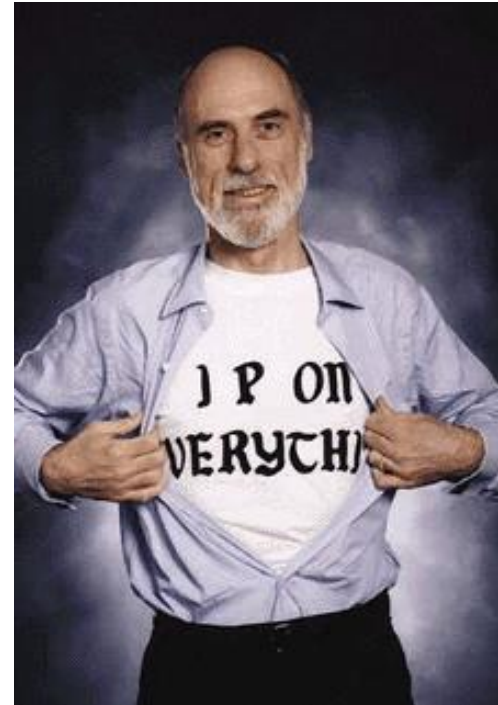

Bob Kahn



© 2009 IEEE

Internet Reference Model

- Internet Protocol (IP) is the “narrow waist”
 - Supports many different links below and apps above

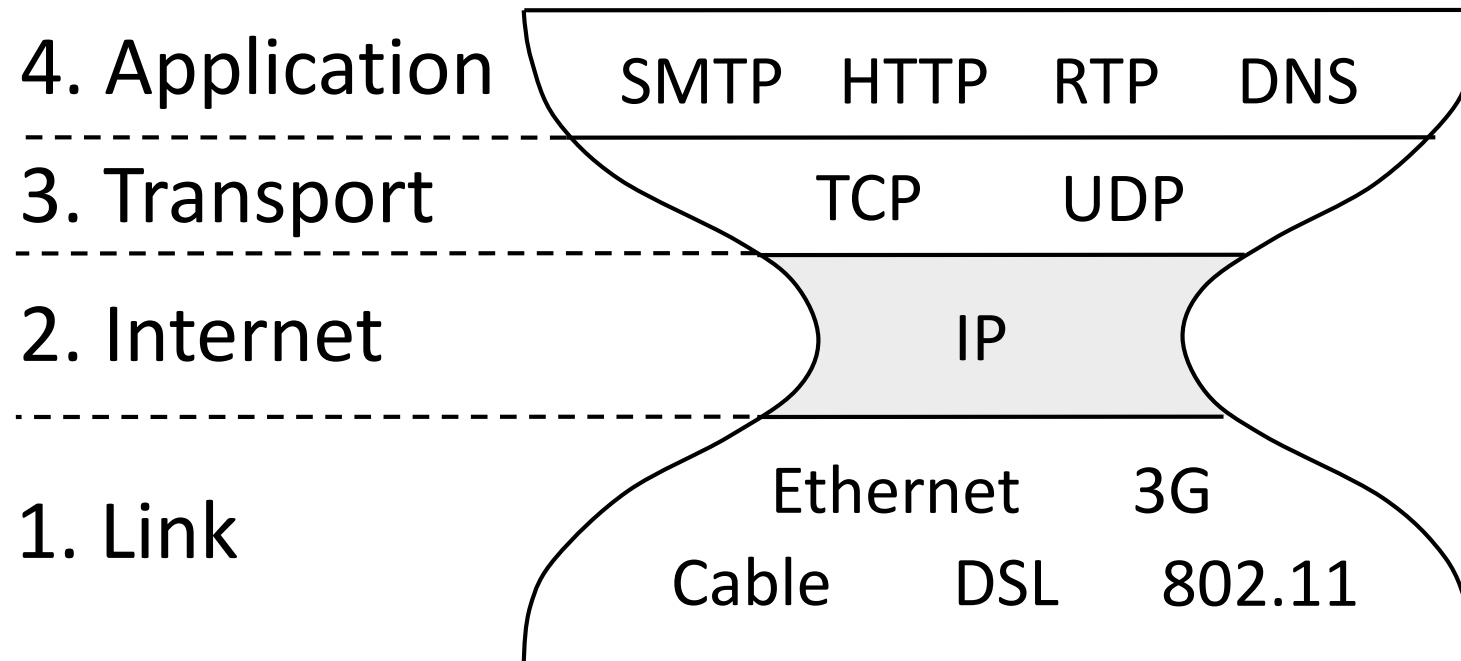

IP as a Lowest Common Denominator

- Suppose only some networks support QOS or security etc.
 - Difficult for internetwork to support
- Pushes IP to be a “lowest common denominator”
 - Asks little of lower-layer networks
 - Gives little as a higher layer service

IPv4 (Internet Protocol)

- Various fields to meet straightforward needs
 - Version, Header (IHL), Total length, Protocol, and Header Checksum

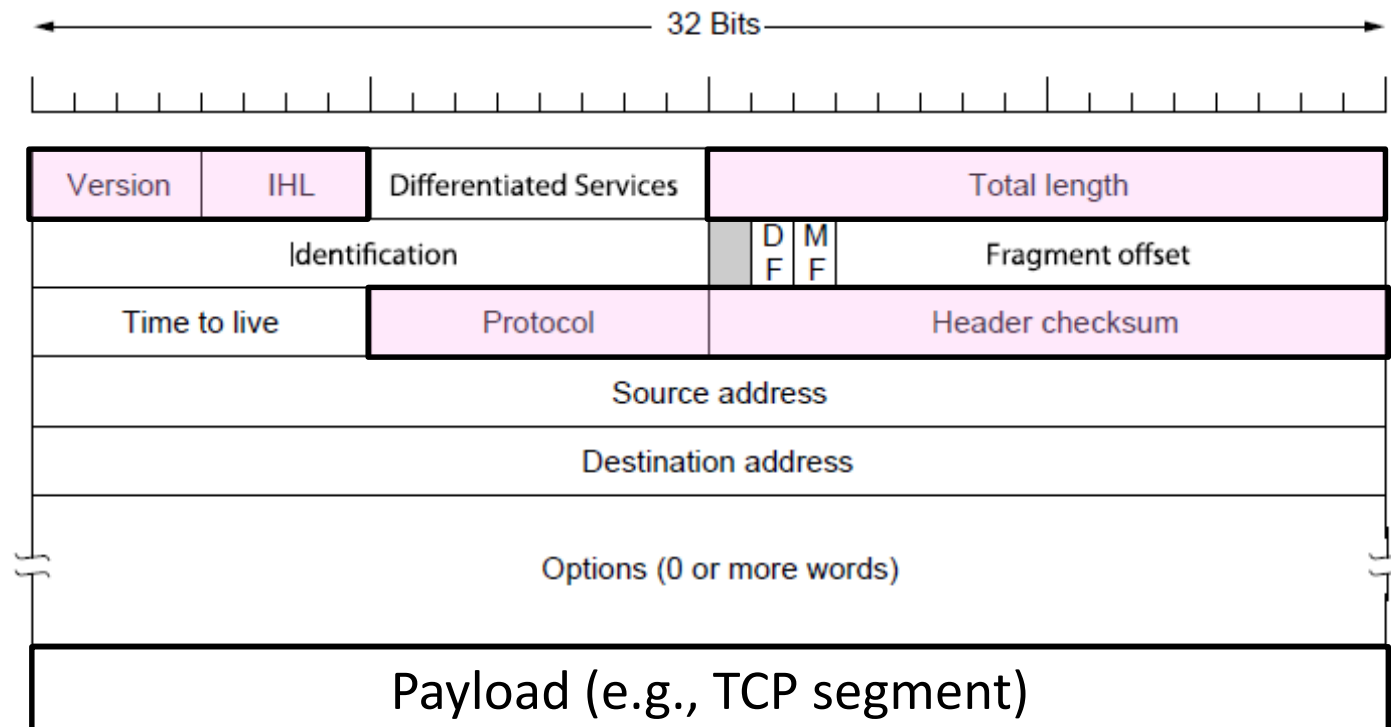

IPv4 (2)

- Some fields to handle packet size differences (later)
 - Identification, Fragment offset, Fragment control bits

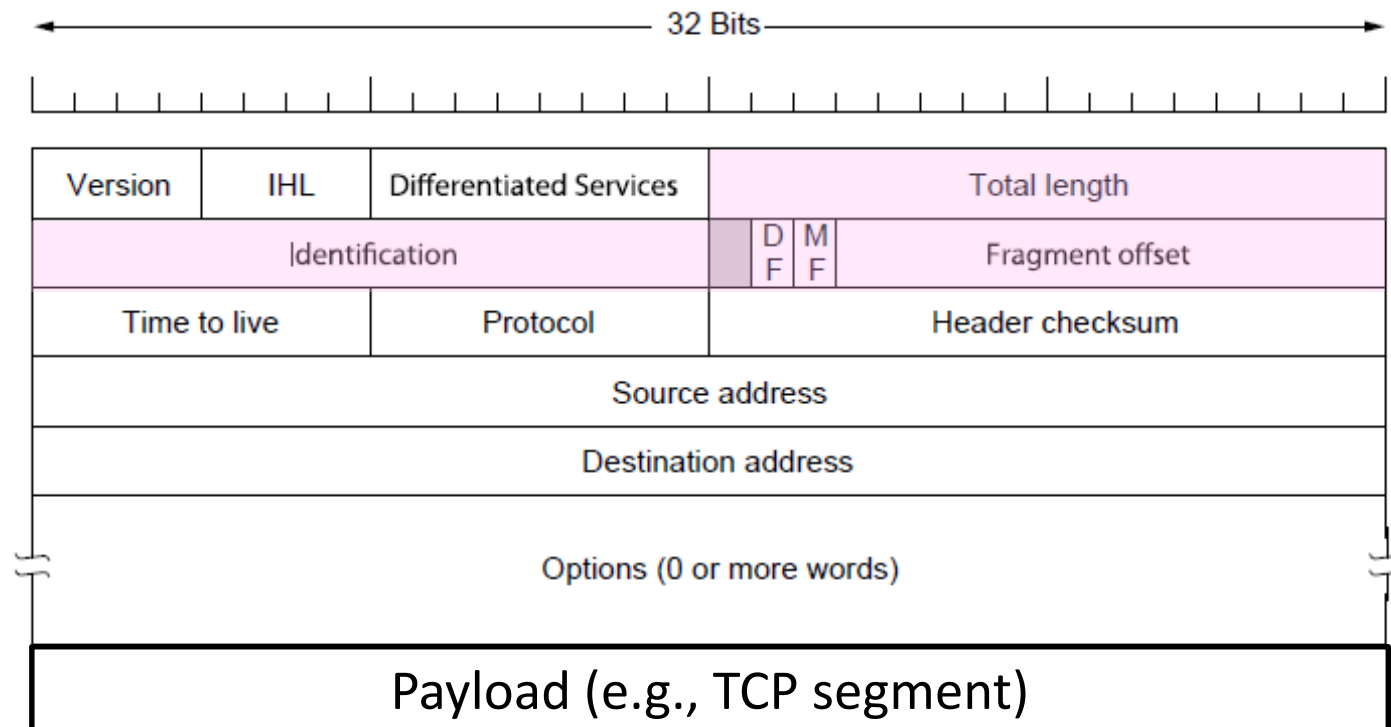

IPv4 (3)

- Other fields to meet other needs (later, later)
 - Differentiated Services, Time to live (TTL)

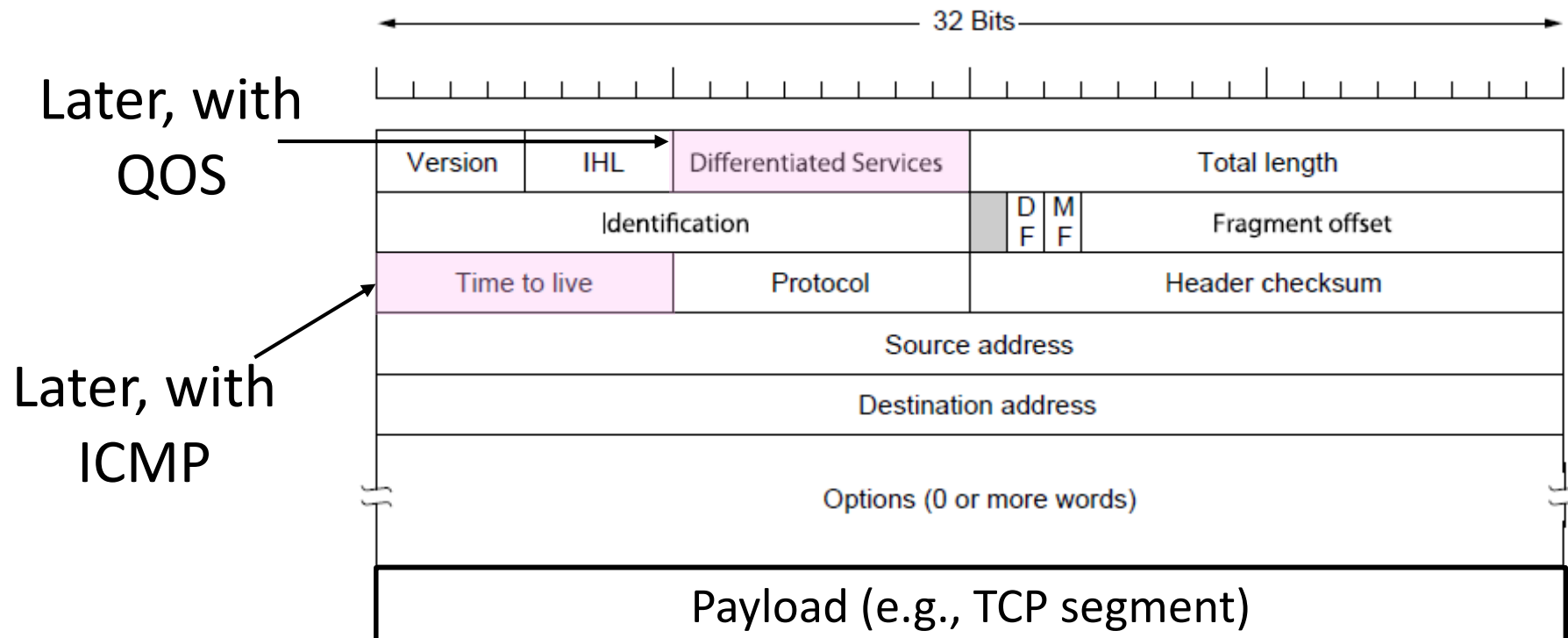

IPv4 (4)

- Network layer of the Internet, uses datagrams
 - Provides a layer of addressing above link addresses (next)

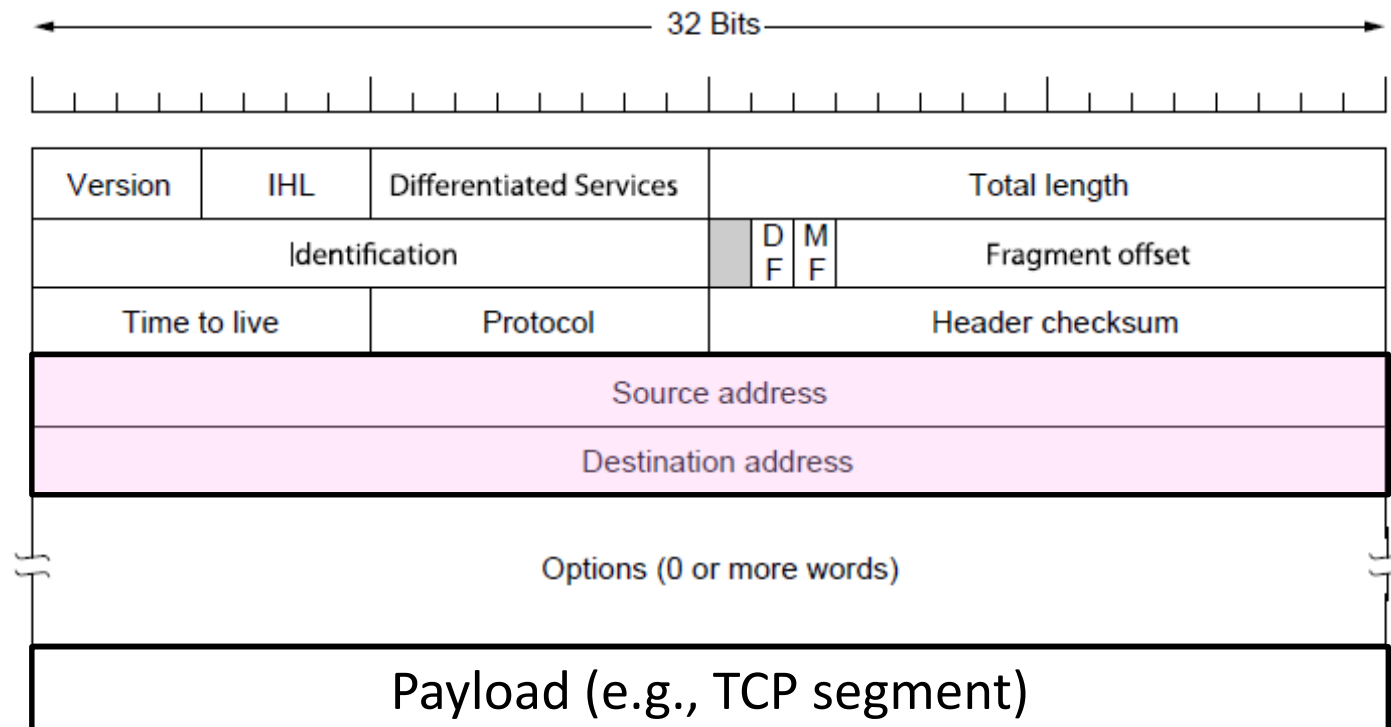

IP Addresses

- IPv4 uses 32-bit addresses
 - Later we'll see IPv6, which uses 128-bit addresses
- Written in “dotted quad” notation
 - Four 8-bit numbers separated by dots

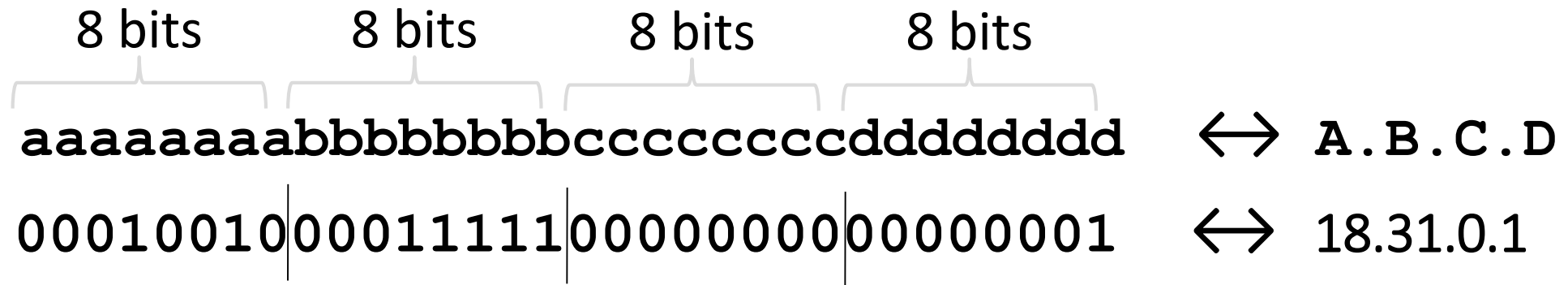

IP Prefixes

- Addresses are allocated in blocks called prefixes
 - Addresses in an L-bit prefix have the same top L bits
 - There are 2^{32-L} addresses aligned on 2^{32-L} boundary

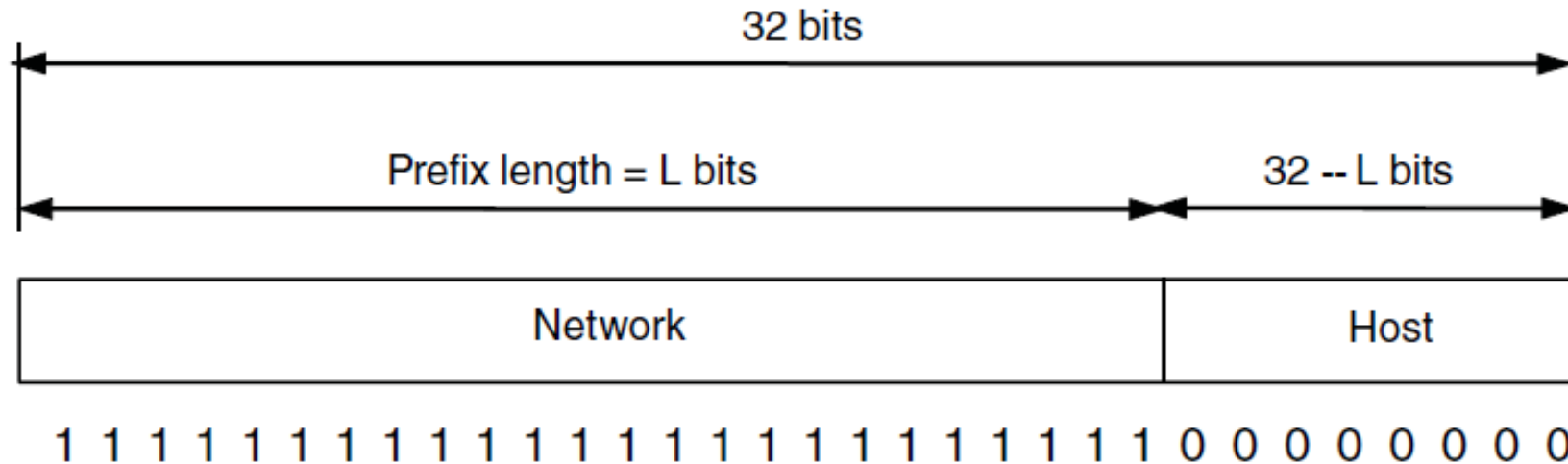

IP Prefixes (2)

- Written in “IP address/length” notation
 - Address is lowest address in the prefix, length is prefix bits
 - E.g., 128.13.0.0/16 is 128.13.0.0 to 128.13.255.255
 - So a /24 (“slash 24”) is 256 addresses, and a /32 is one address

00010010|00011111|00000000|xxxxxxxx ↔ 18.31.0.0/24

10000000|00001101|xxxxxxxxxxxxxxxx ↔ 128.13.0.0/16

Classful IP Addressing

- Originally, IP addresses came in fixed size blocks with the class/size encoded in the high-order bits
 - They still do, but the classes are now ignored

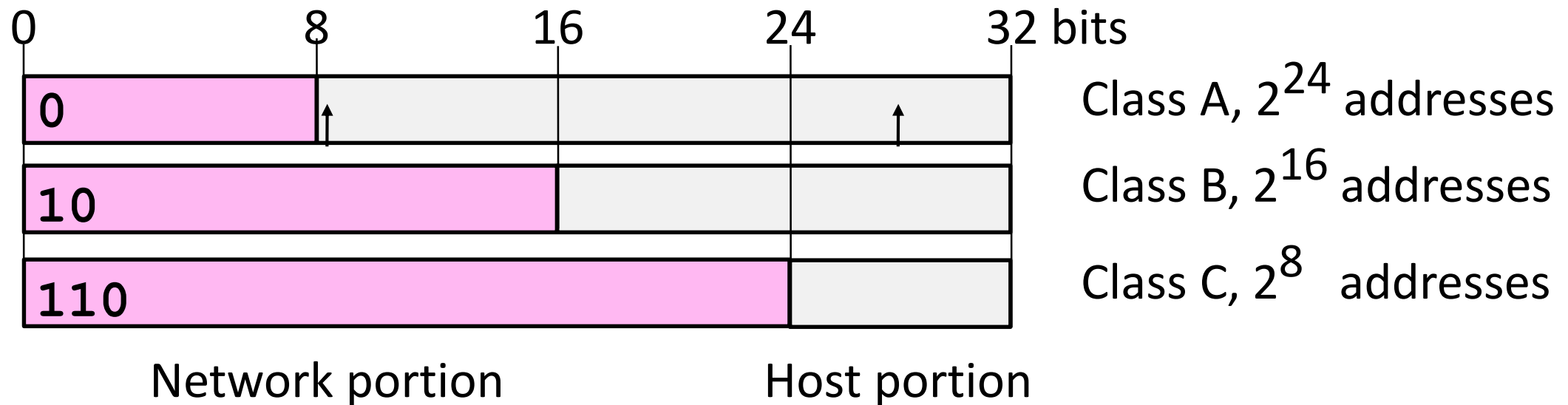

Classful IP Addressing

- This is an ARPANet assignment.

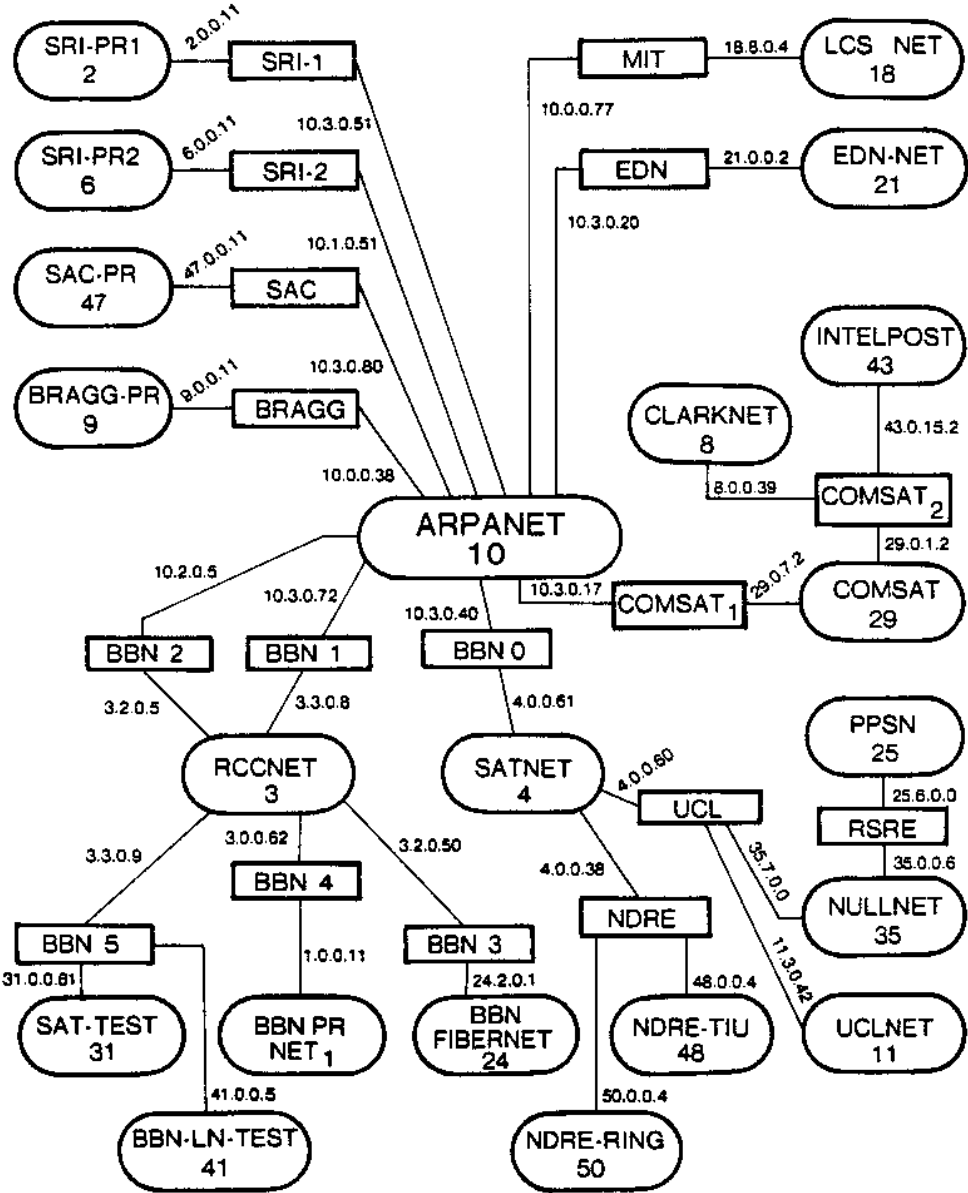

IP Forwarding

- Addresses on one network belong to a unique prefix
- Node uses a table that lists the next hop for prefixes

Prefix	Next Hop
192.24.0.0/19	D
192.24.12.0/22	B

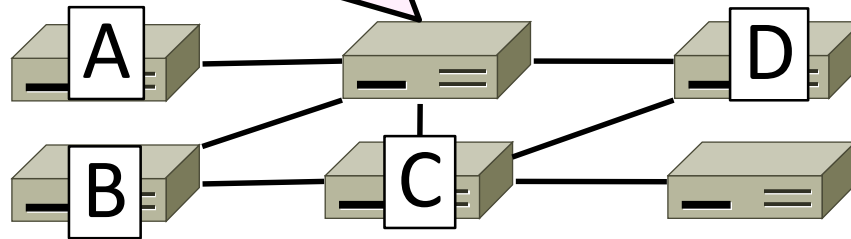

Longest Matching Prefix

- Prefixes in the table might overlap!
 - Combines hierarchy with flexibility
- Longest matching prefix forwarding rule:
 - For each packet, find the longest prefix that contains the destination address, i.e., the most specific entry
 - Forward the packet to the next hop router for that prefix

Longest Matching Prefix (2)

Prefix	Next Hop
192.24.0.0/19	D
192.24.12.0/22	B

192.24.6.0 →
192.24.14.32 →
192.24.54.0 →

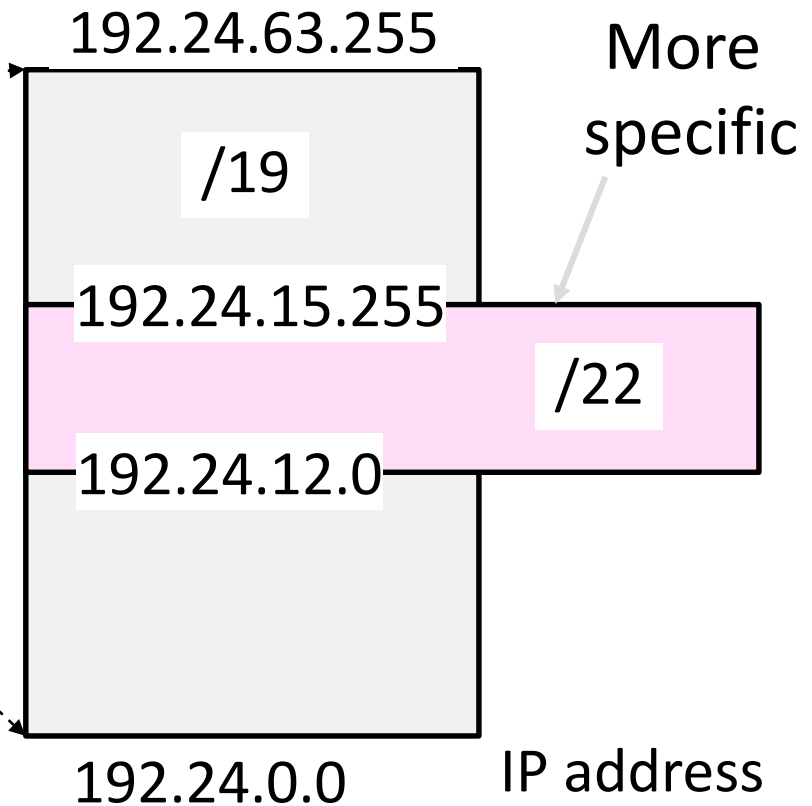

IP Address Work Slide:

- Route to D = 192.00011x.x.x
- Route to B = 192.00011000.000011x.x
- 192.24.6.0 = 192.00011000.00000110.00000000
- 192.24.14.32 = 192.00011000.00001110.00010000
- 192.24.54.0 = 192.00011000.00110110.00000000

Longest Matching Prefix (2)

Prefix	Next Hop
192.24.0.0/19	D
192.24.12.0/22	B

192.24.6.0 → D
192.24.14.32 → B
192.24.54.0 → D

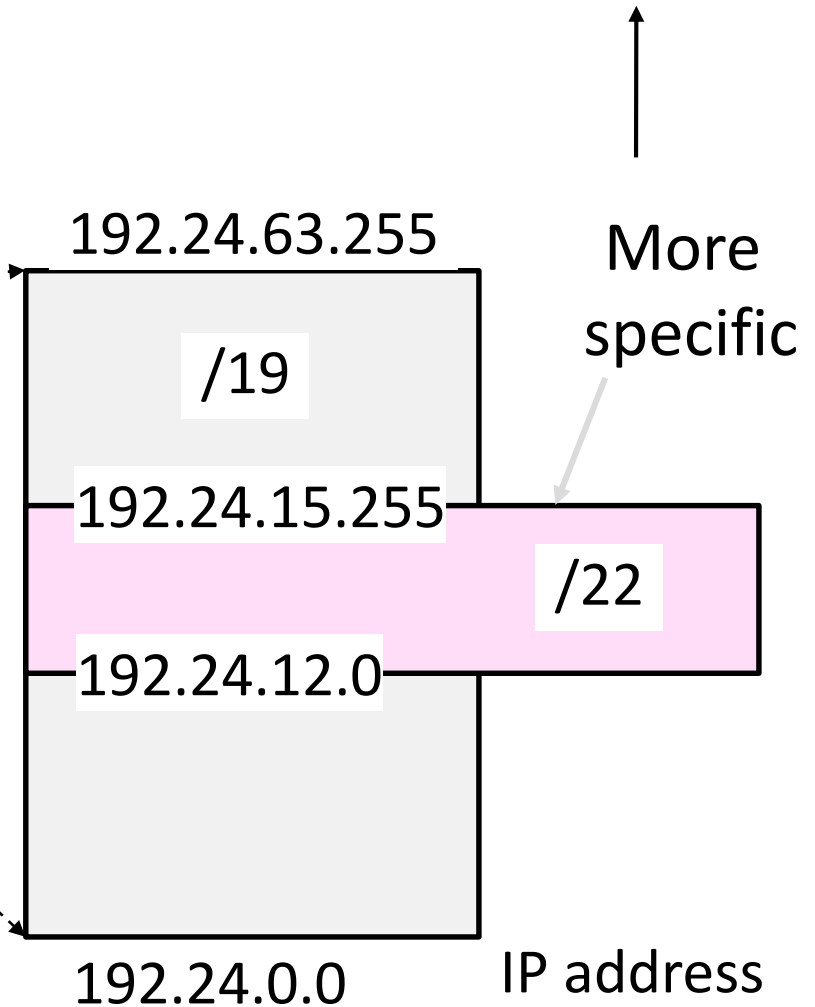

Host/Router Distinction

- In the Internet:
 - Routers do the routing, know way to all destinations
 - Hosts send remote traffic (out of prefix) to nearest router

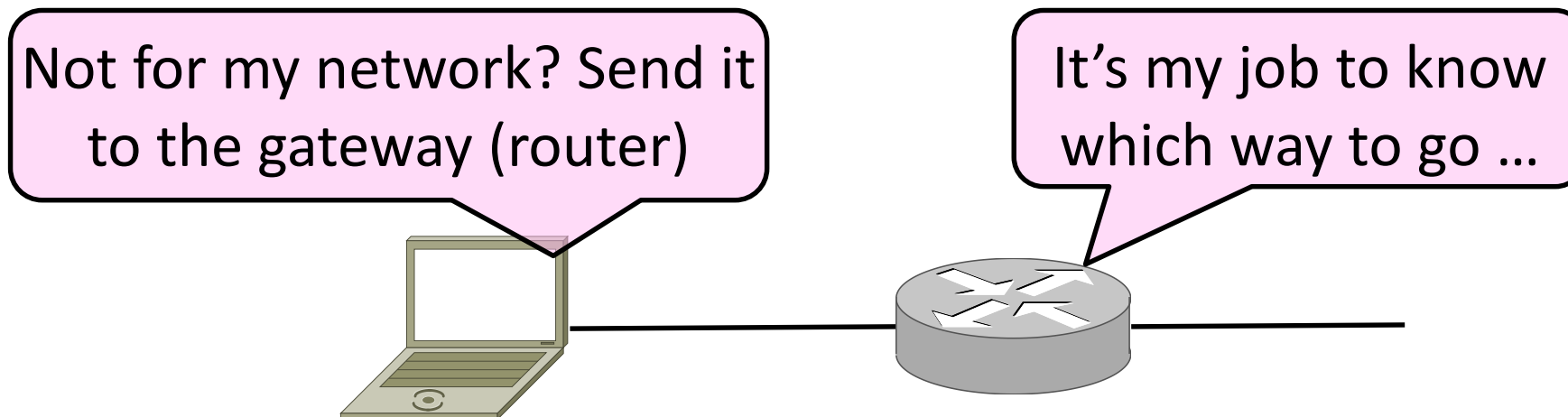

Host Networking

- Consists of 4 pieces of data:
 - IP Address
 - Subnet Mask
 - Defines local addresses
 - Gateway
 - Who (local) to send non-local packets to for routing
 - DNS Server (Later)

Host Forwarding Table

- Give using longest matching prefix
 - 0.0.0.0/0 is a default route that catches all IP addresses

Prefix	Next Hop
My network prefix	Send to that IP
0.0.0.0/0	Send to my router

Flexibility of Longest Matching Prefix

- Can provide default behavior, with less specifics
 - Send traffic going outside an organization to a border router (gateway)
- Can special case behavior, with more specifics
 - For performance, economics, security, ...

Performance of Longest Matching Prefix

- Uses hierarchy for a compact table
 - Relies on use of large prefixes
- Lookup more complex than table
 - Used to be a concern for fast routers
 - Not an issue in practice these days

Issues?

- What's still not solved?

Issues?

- Where does this break down?

Bootstrapping (DHCP)

Finding Link nodes (ARP)

~~Really big packets (Fragmentation)~~

Errors in the network (ICMP)

Running out of addresses (IPv6, NAT)

Dynamic Host Configuration Protocol (DHCP)

Bootstrapping

- Problem:
 - A node wakes up for the first time ...
 - What is its IP address? What's the IP address of its router?
 - At least Ethernet address is on NIC

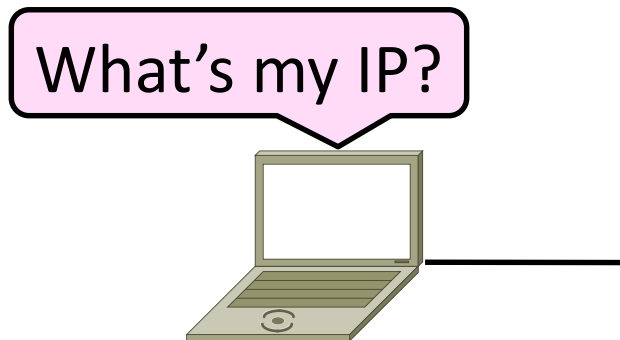

Bootstrapping (2)

1. Manual configuration (old days)
 - Can't be factory set, depends on use
2. DHCP: Automatically configure addresses
 - Shifts burden from users to IT folk

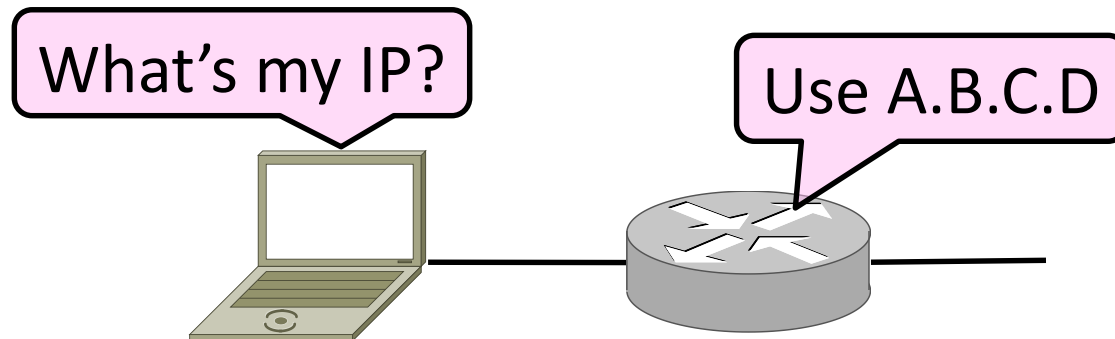

DHCP

- DHCP (Dynamic Host Configuration Protocol), from 1993, widely used
- It leases IP address to nodes
- Provides other parameters too
 - Network prefix
 - Address of local router
 - DNS server, time server, etc.

DHCP Protocol Stack

- DHCP is a client-server application
 - Uses UDP ports 67, 68

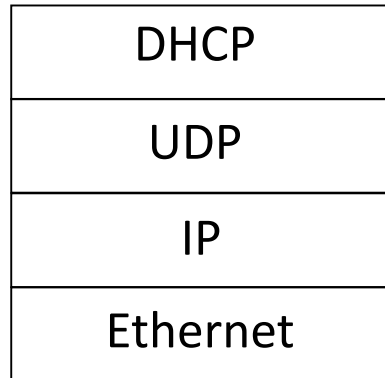

DHCP Addressing

- Bootstrap issue:
 - How does node send a message to DHCP server before it is configured?
- Answer:
 - Node sends broadcast messages that delivered to all nodes on the network
 - Broadcast address is all 1s
 - IP (32 bit): 255.255.255.255
 - Ethernet (48 bit): ff:ff:ff:ff:ff:ff

DHCP Messages

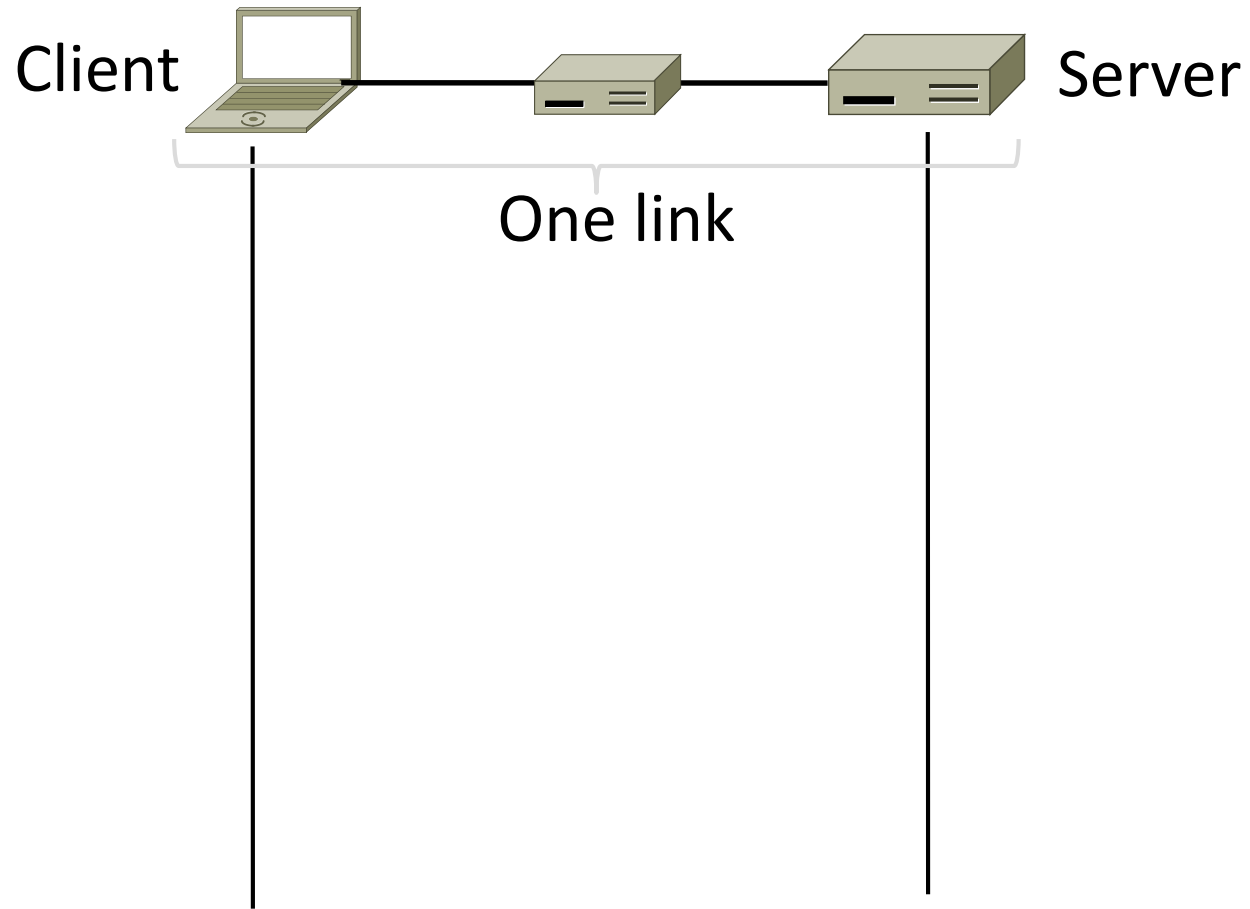

DHCP Messages (2)

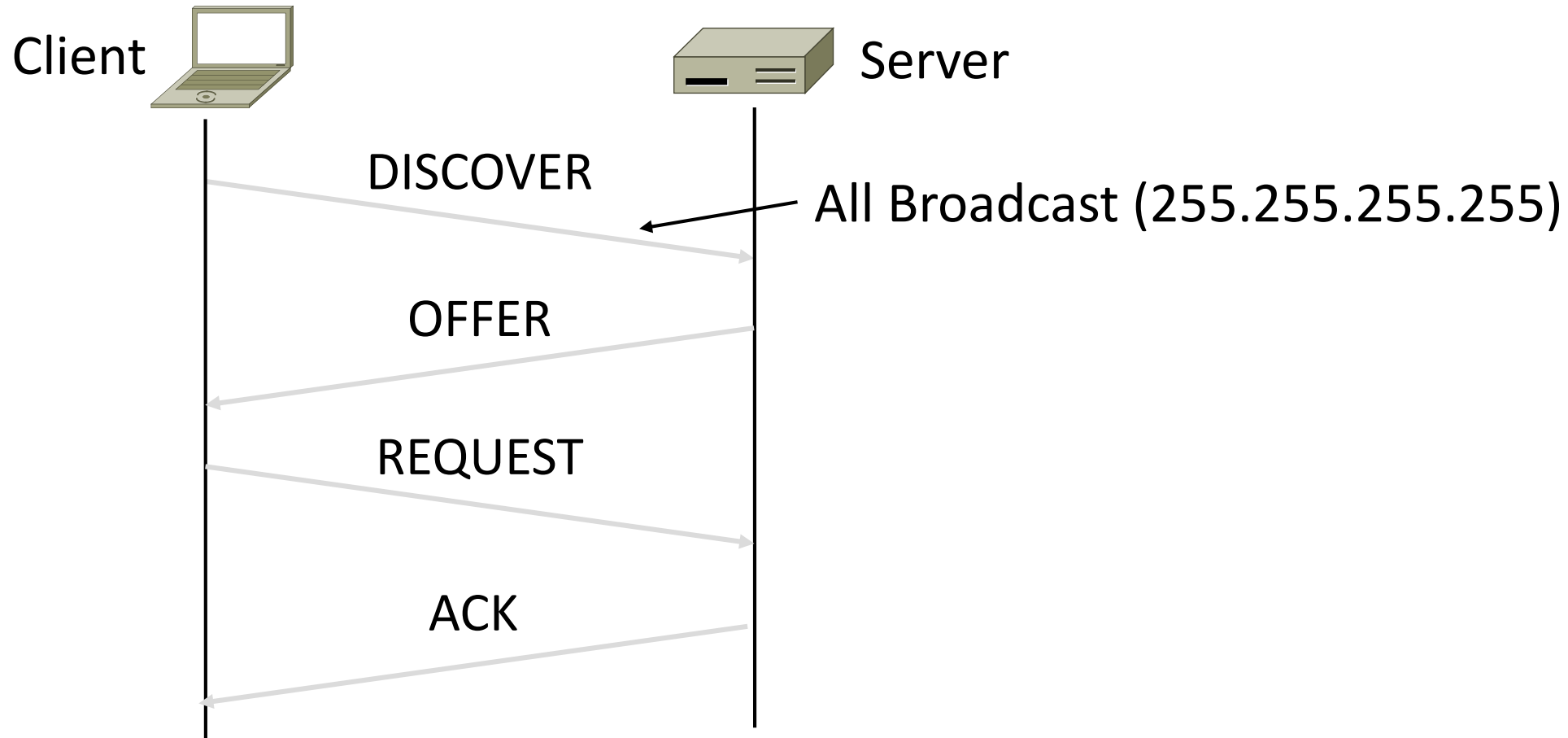

DHCP Messages (3)

- To renew an existing lease, an abbreviated sequence is used:
 - REQUEST, followed by ACK
- Protocol also supports replicated servers for reliability

Address Resolution Protocol (ARP)

Sending an IP Packet

- **Problem:**
 - A node needs Link layer addresses to send a frame over the local link
 - How does it get the destination link address from a destination IP address?

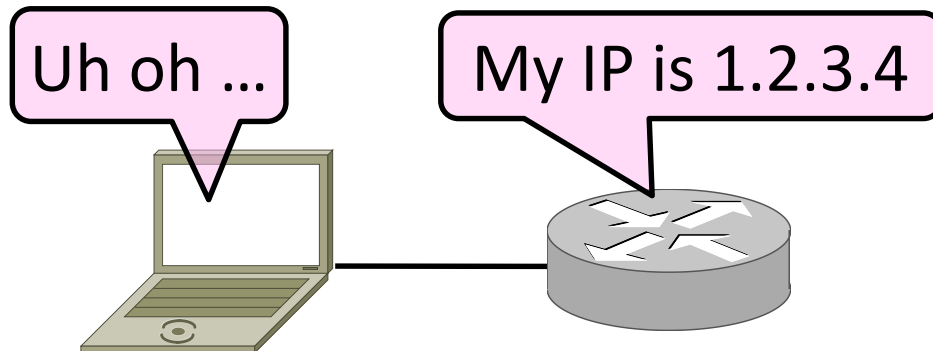

ARP Protocol Stack

- ARP sits right on top of link layer
 - No servers, just asks node with target IP to identify itself
 - Uses broadcast to reach all nodes

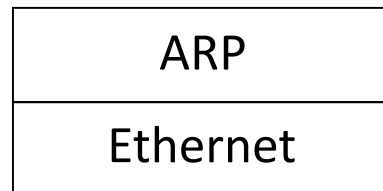

ARP Messages

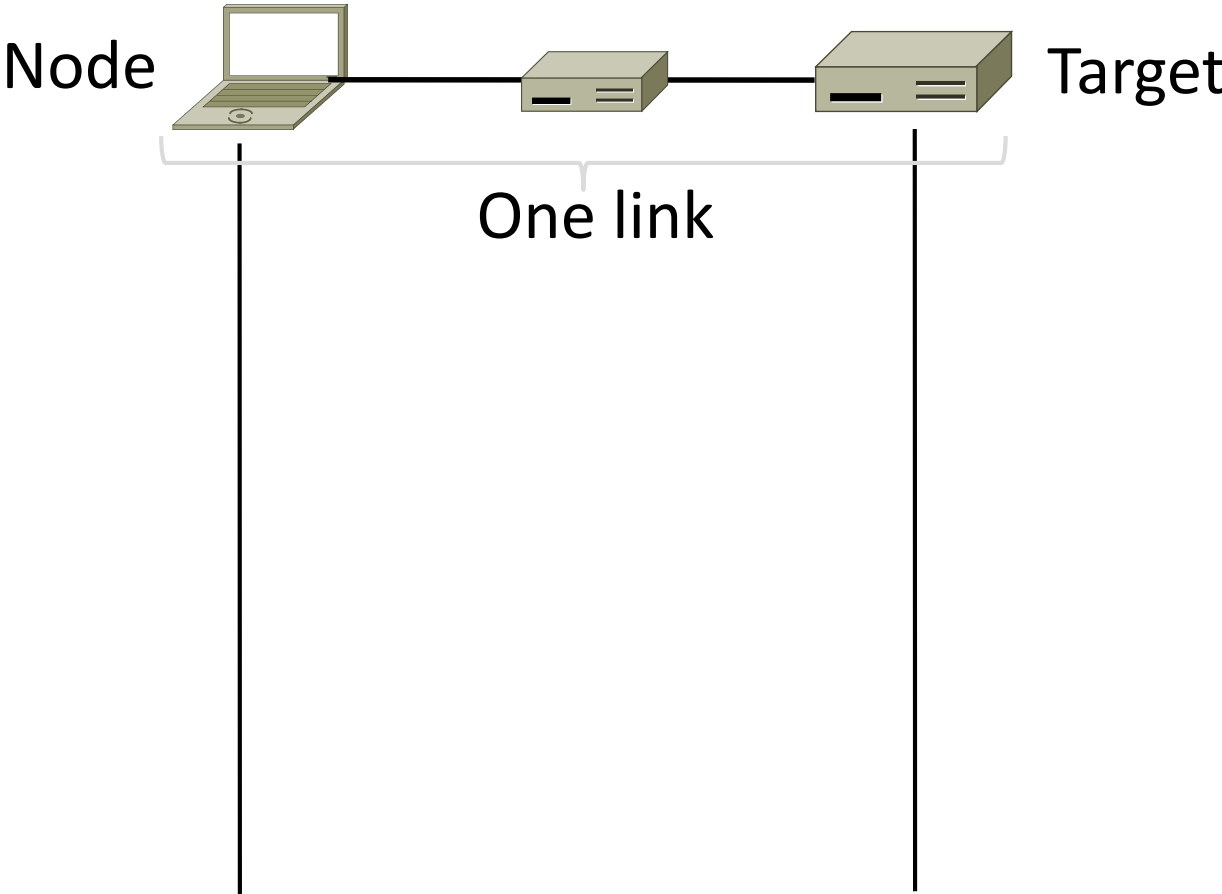

ARP Messages (2)

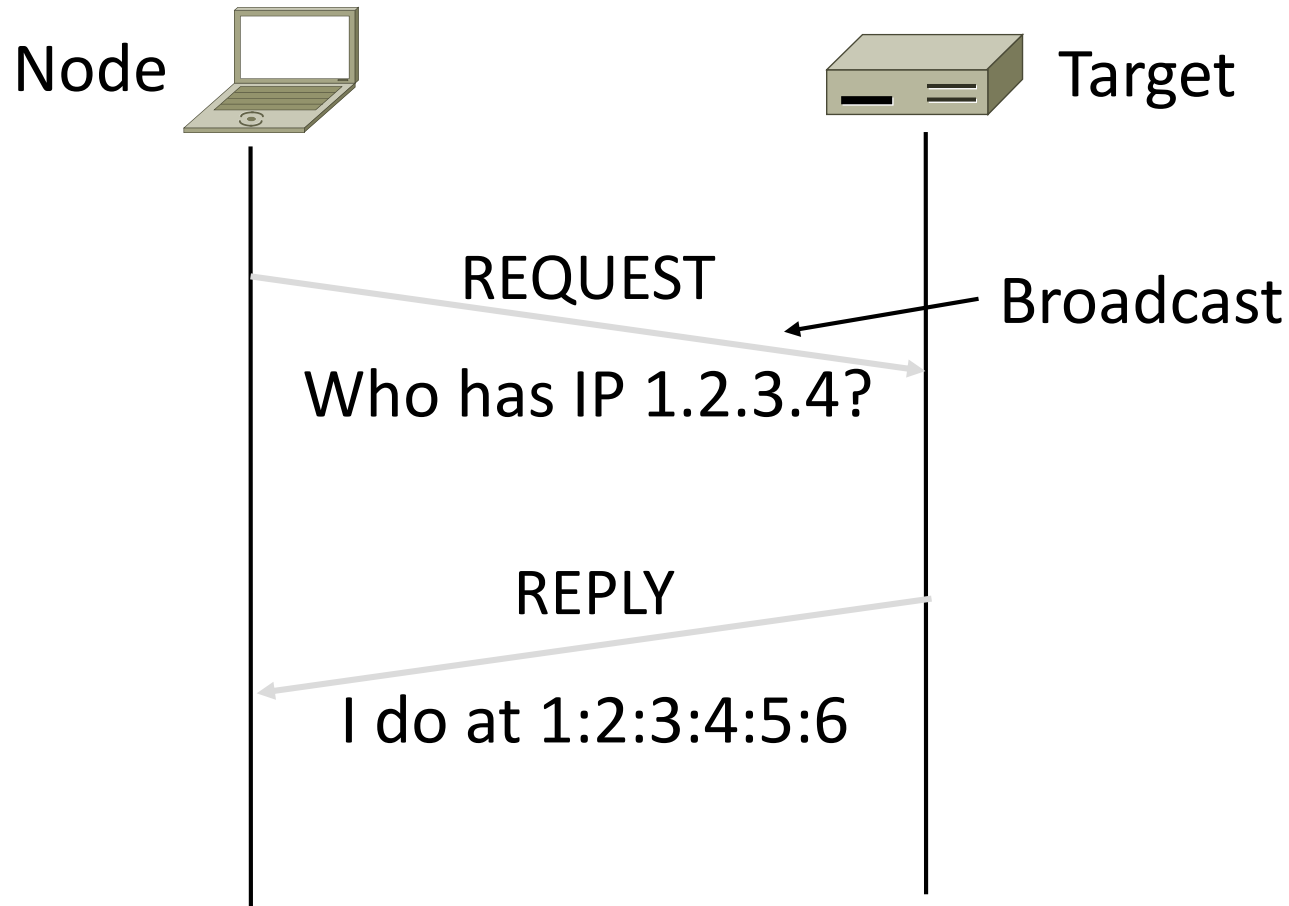

```
[root@host ~]# tcpdump -lni any arp &  
( sleep 1; arp -d 10.0.0.254; ping -c1 -n  
10.0.0.254 )
```

```
listening on any, link-type LINUX_SLL  
(Linux cooked), capture size 96 bytes
```

```
17:58:02.155495 arp who-has  
10.2.1.224 tell 10.2.1.253
```

```
17:58:02.317444 arp who-has 10.0.0.96  
tell 10.0.0.253
```

```
17:58:02.370446 arp who-has 10.3.1.12  
tell 10.3.1.61
```

ARP Table

```
# arp -an | grep 10
```

```
? (10.241.1.114) at 00:25:90:3e:dc:fc [ether] on vlan241
```

```
? (10.252.1.8) at 00:c0:b7:76:ac:19 [ether] on vlan244
```

```
? (10.252.1.9) at 00:c0:b7:76:ae:56 [ether] on vlan244
```

```
? (10.241.1.111) at 00:30:48:f2:23:fd [ether] on vlan241
```

```
? (10.252.1.6) at 00:c0:b7:74:fb:9a [ether] on vlan244
```

```
? (10.241.1.121) at 00:25:90:2c:d4:f7 [ether] on vlan241
```

```
[...]
```

Discovery Protocols

- Help nodes find each other
 - There are more of them!
 - E.g., Zeroconf, Bonjour
- Often involve broadcast
 - Since nodes aren't introduced
 - Very handy glue

Internet Control Message Protocol (ICMP)

Topic

- Problem: What happens when something goes wrong during forwarding?
 - Need to be able to find the problem

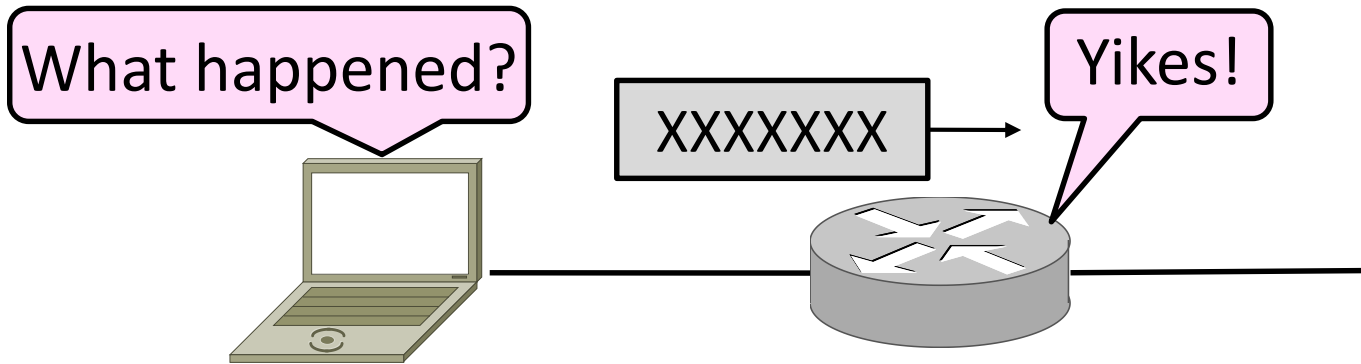

Internet Control Message Protocol

- ICMP is a companion protocol to IP
 - They are implemented together
 - Sits on top of IP (IP Protocol=1)
- Provides error report and testing
 - Error is at router while forwarding
 - Also testing that hosts can use

ICMP Errors

- When router encounters an error while forwarding:
 - It sends an ICMP error report back to the IP source
 - It discards the problematic packet; host needs to rectify

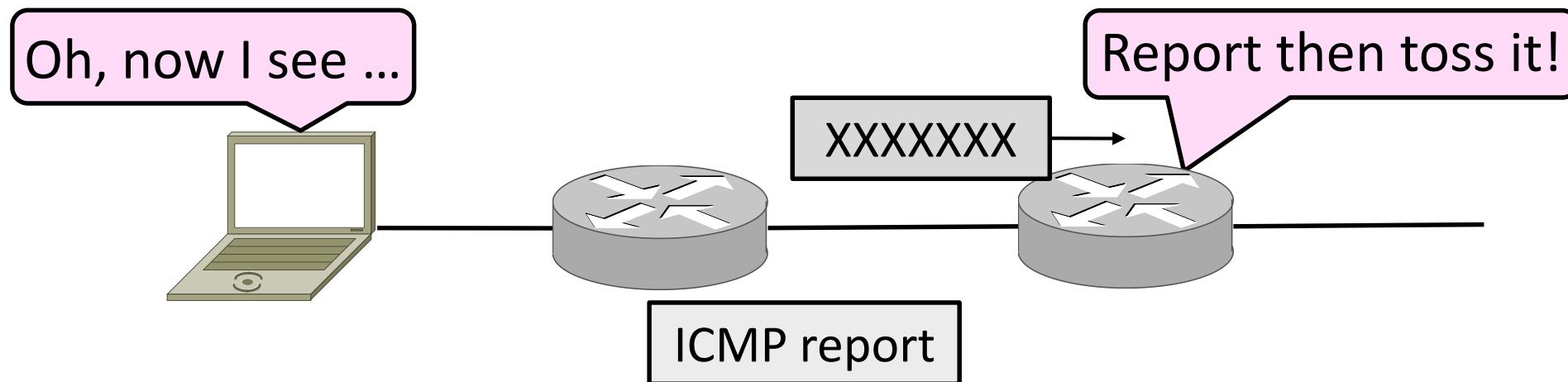

ICMP Message Format (2)

- Each ICMP message has a Type, Code, and Checksum
- Often carry the start of the offending packet as payload
- Each message is carried in an IP packet

Portion of offending packet,
starting with its IP header

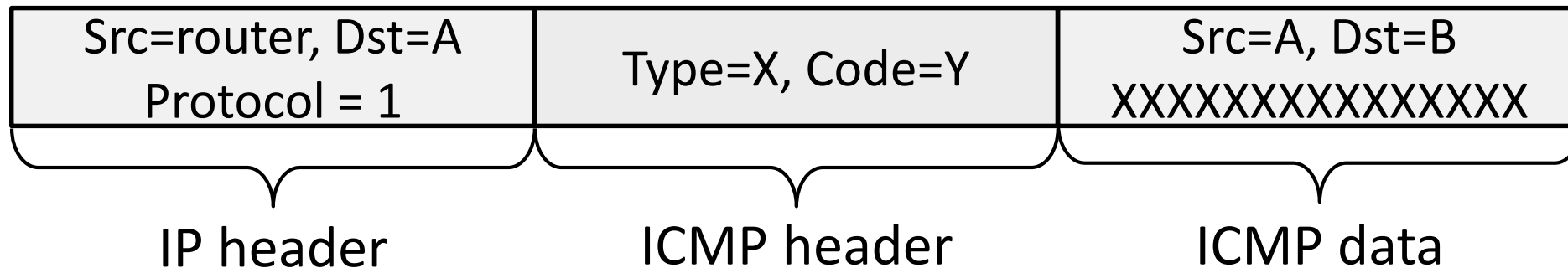

Example ICMP Messages

Name	Type / Code	Usage
Dest. Unreachable (Net or Host)	3 / 0 or 1	Lack of connectivity
Dest. Unreachable (Fragment)	3 / 4	Path MTU Discovery
Time Exceeded (Transit)	11 / 0	Traceroute
Echo Request or Reply	8 or 0 / 0	Ping

Testing, not a forwarding error: Host sends Echo Request, and destination responds with an Echo Reply



Traceroute

- IP header contains TTL (Time to live) field
 - Decrement every router hop, with ICMP error at zero
 - Protects against forwarding loops

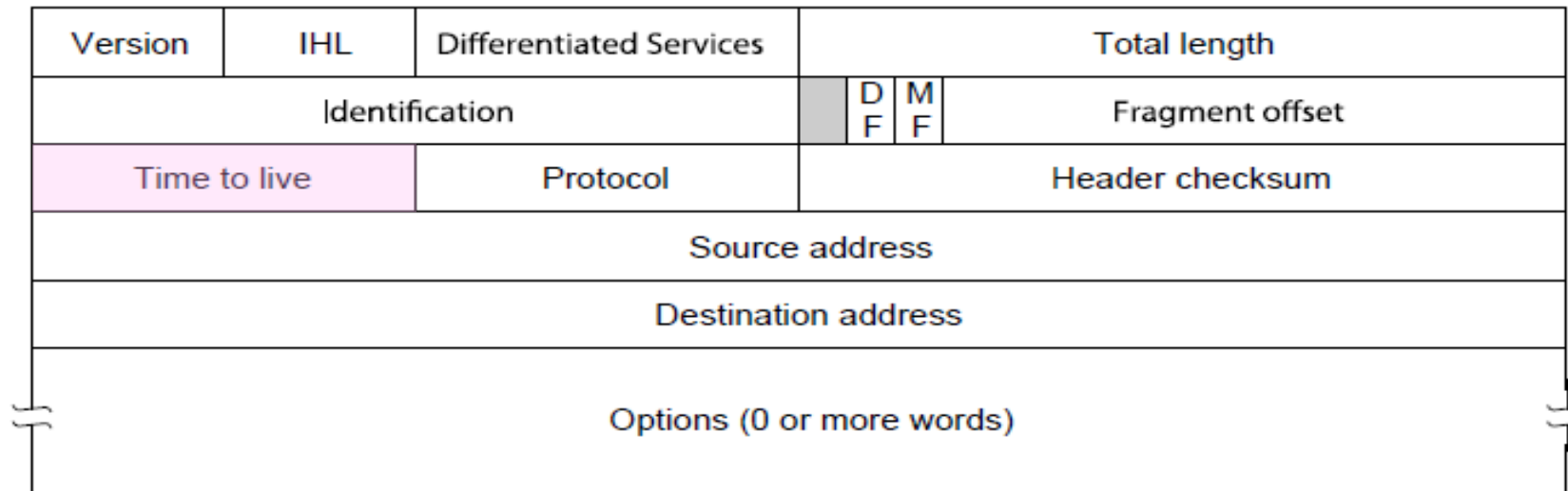

Traceroute (2)

- Traceroute repurposes TTL and ICMP functionality
 - Sends probe packets increasing TTL starting from 1
 - ICMP errors identify routers on the path

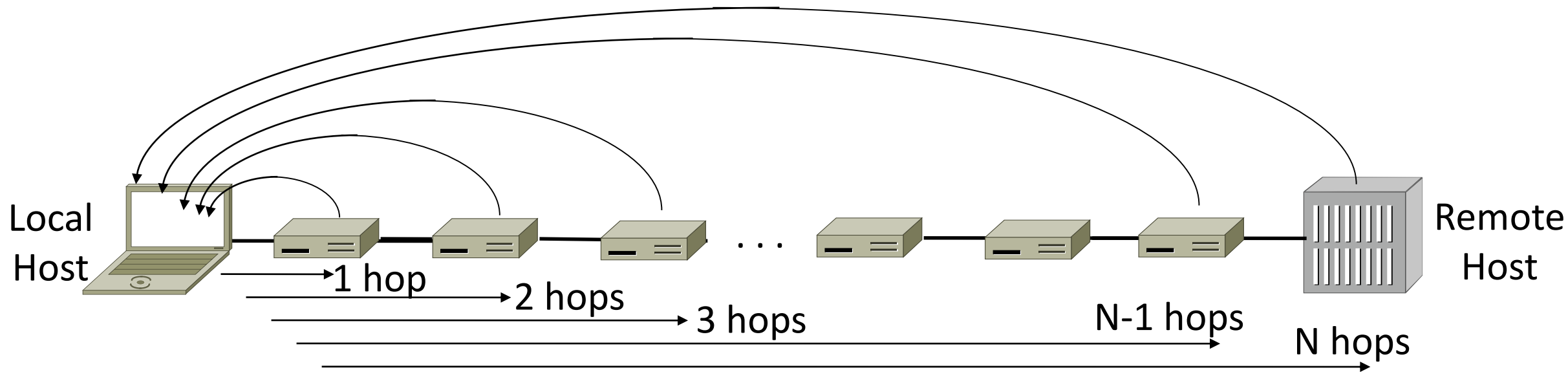

Network Address Translation (NAT)

Problem: Internet Growth

- Many billions of hosts
- And we're using 32-bit addresses!

Internet Domain Survey Host Count

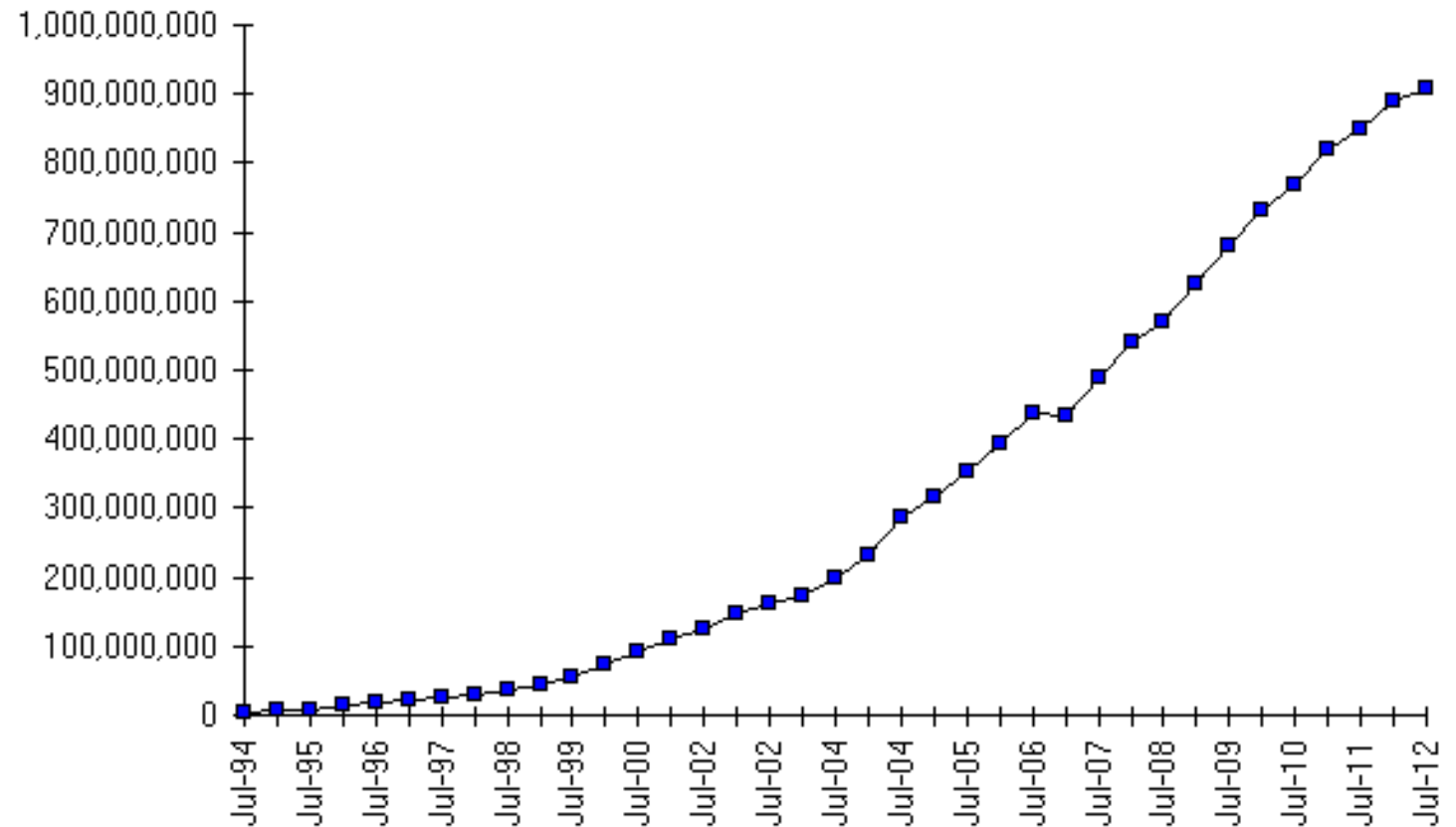

Source: Internet Systems Consortium (www.isc.org)

The End of New IPv4 Addresses

- Now running on leftover blocks held by the regional registries; much tighter allocation policies

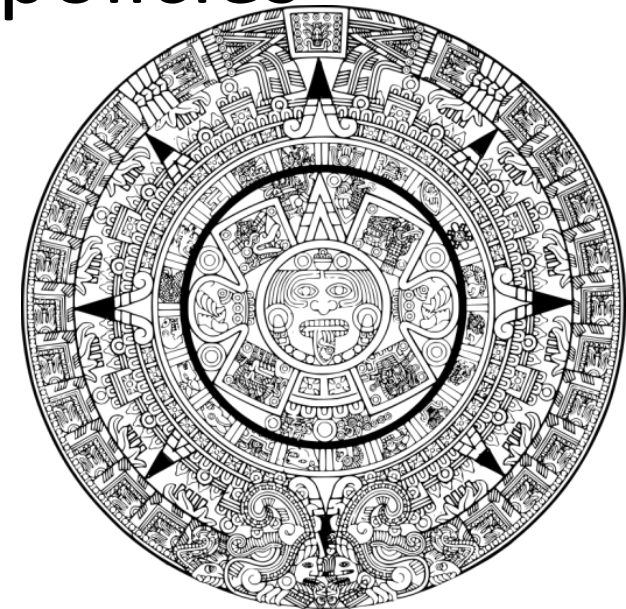
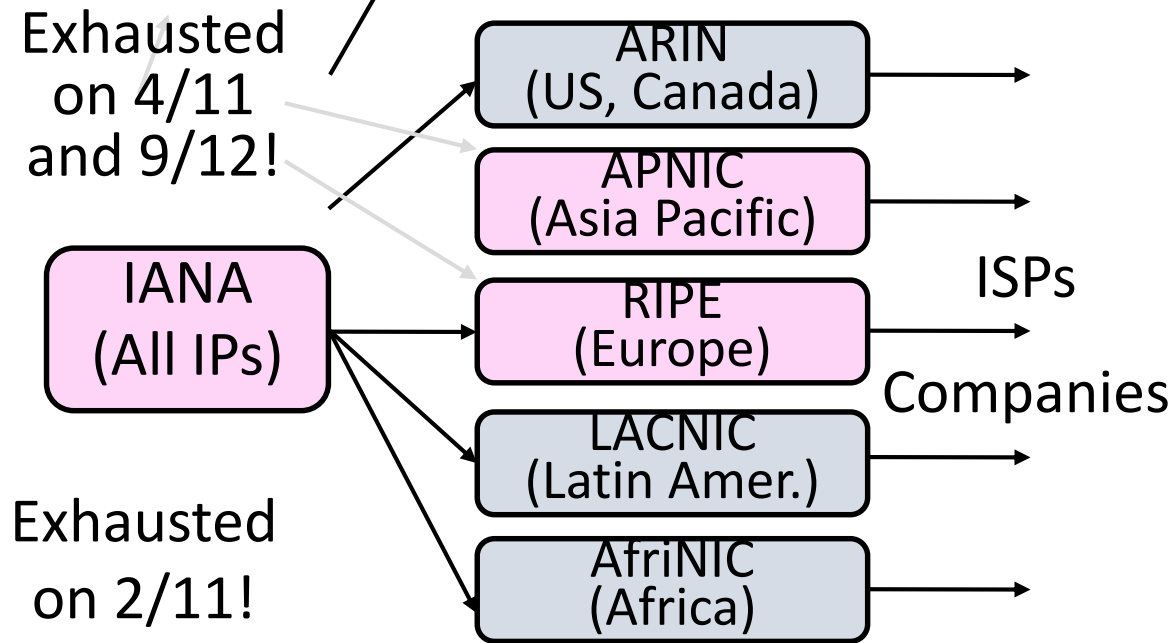

End of the world ? 12/21/12?

Solution 1: Network Address Translation (NAT)

- Basic idea: Map many “Private” IP addresses to one “Public” IP.
- Allocate IPs for private use (192.168.x, 10.x)

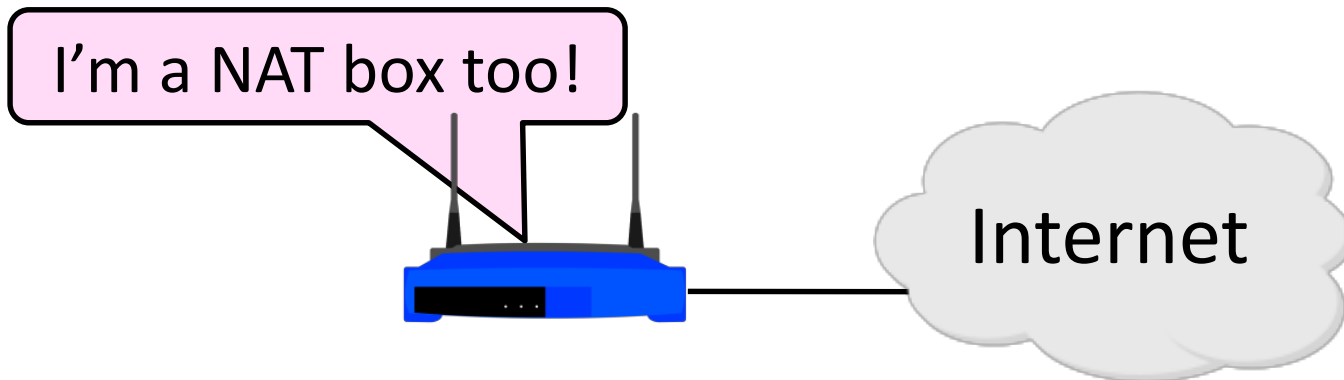

Layering Review

- Remember how layering is meant to work?
 - “Routers don’t look beyond the IP header.” Well ...

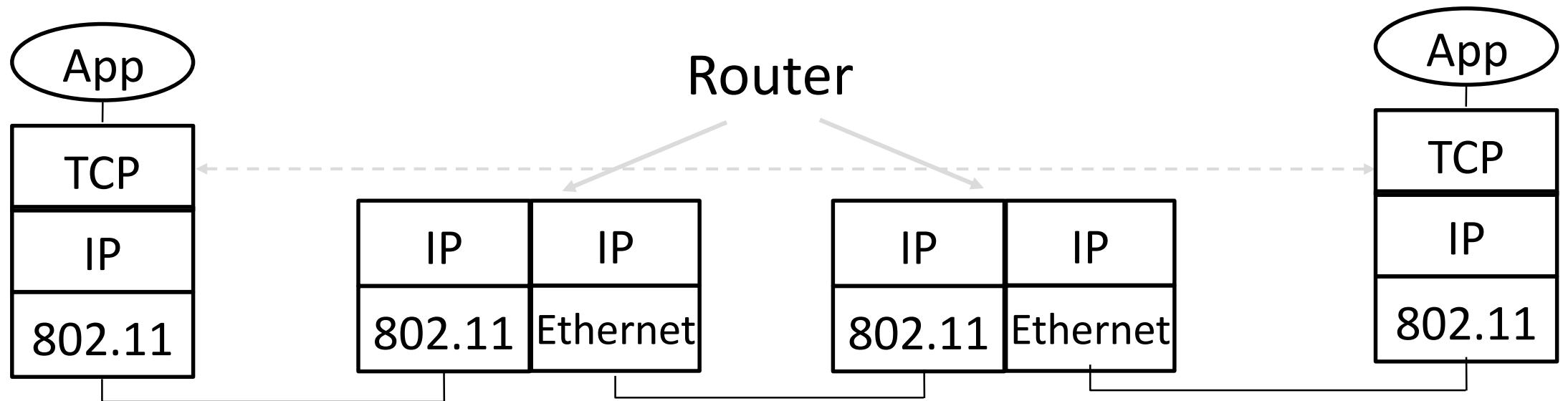

Middleboxes

- Sit “inside the network” but perform “more than IP” processing on packets to add new functionality
 - NAT box, Firewall / Intrusion Detection System

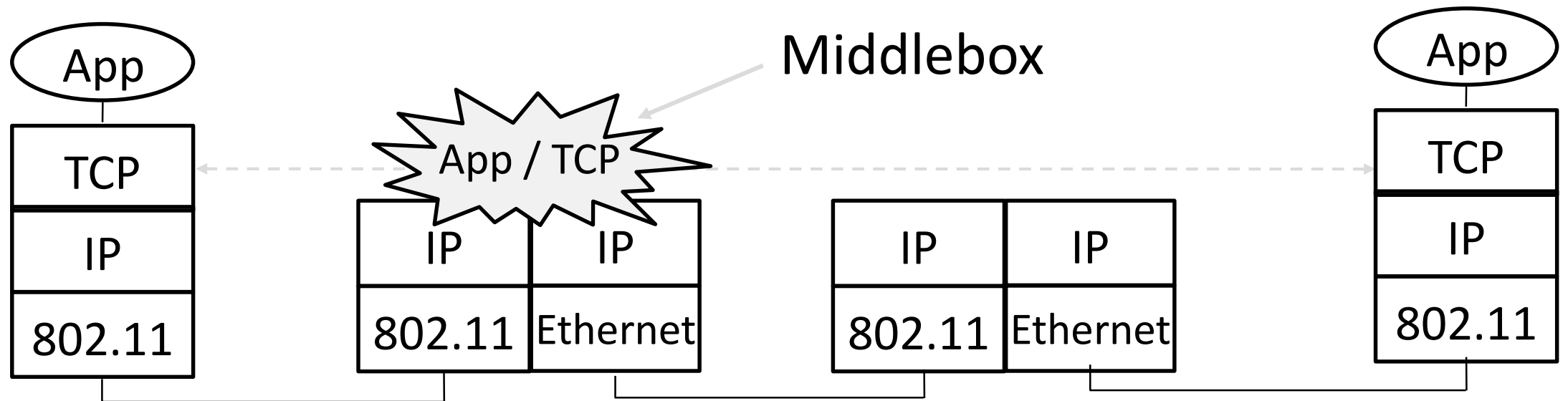

Middleboxes (2)

- Advantages

- A possible rapid deployment path when no other option
- Control over many hosts (IT)

- Disadvantages

- Breaking layering interferes with connectivity
 - strange side effects
- Poor vantage point for many tasks

NAT (Network Address Translation) Box

- NAT box maps an internal IP to an external IP
 - Many internal hosts connected using few external addresses
 - Middlebox that “translates addresses”
- Motivated by IP address scarcity
 - Controversial at first, now accepted

NAT (2)

- Common scenario:
 - Home computers use “private” IP addresses
 - NAT (in AP/firewall) connects home to ISP using a single external IP address

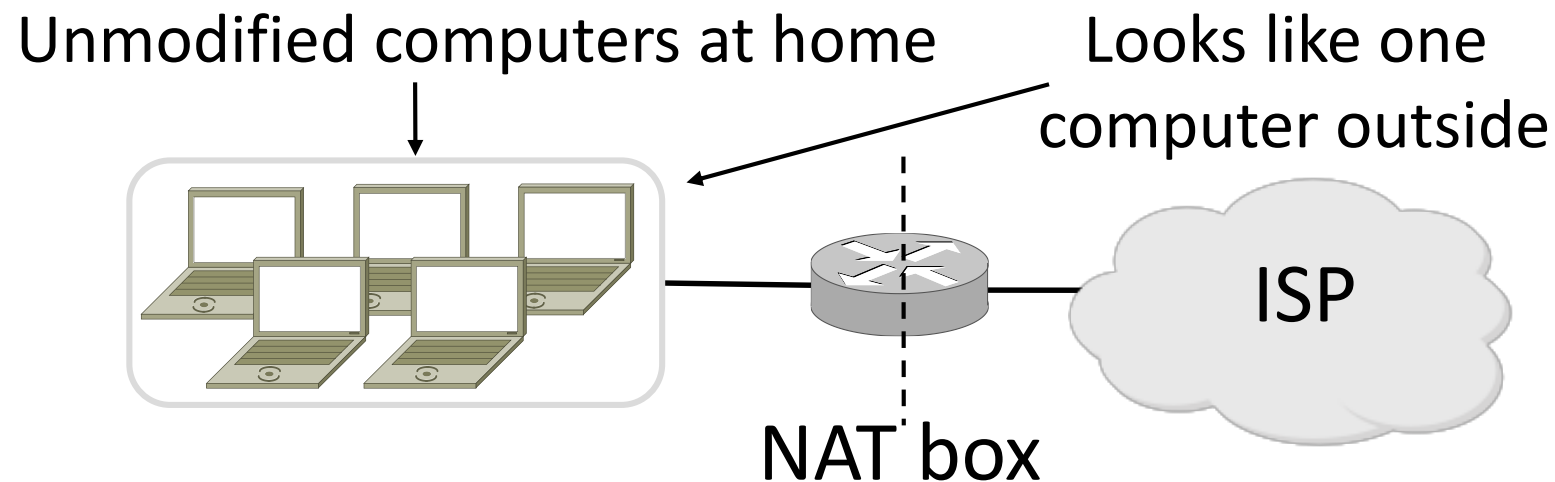

How NAT Works

- Keeps an internal/external translation table
 - Typically uses IP address + TCP port
 - This is address and port translation

What host thinks	What ISP thinks
Internal IP:port	External IP : port
192.168.1.12 : 5523	44.25.80.3 : 1500
192.168.1.13 : 1234	44.25.80.3 : 1501
192.168.2.20 : 1234	44.25.80.3 : 1502

- Need ports to make mapping 1-1 since there are fewer external IPs

How NAT Works (2)

- Internal → External:
 - Look up and rewrite Source IP/port

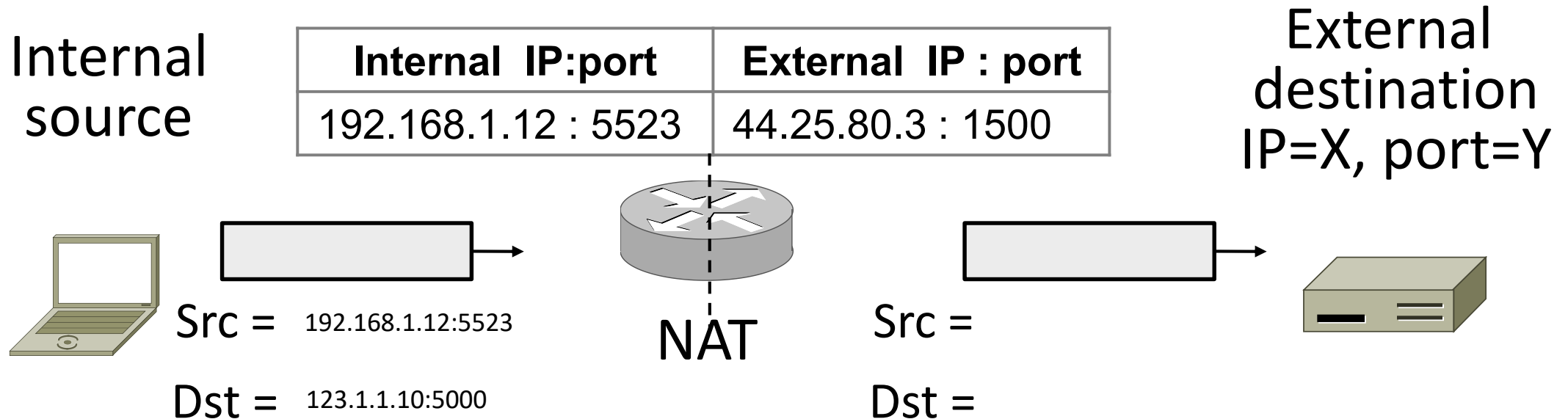

How NAT Works (2)

- Internal → External:
 - Look up and rewrite Source IP/port

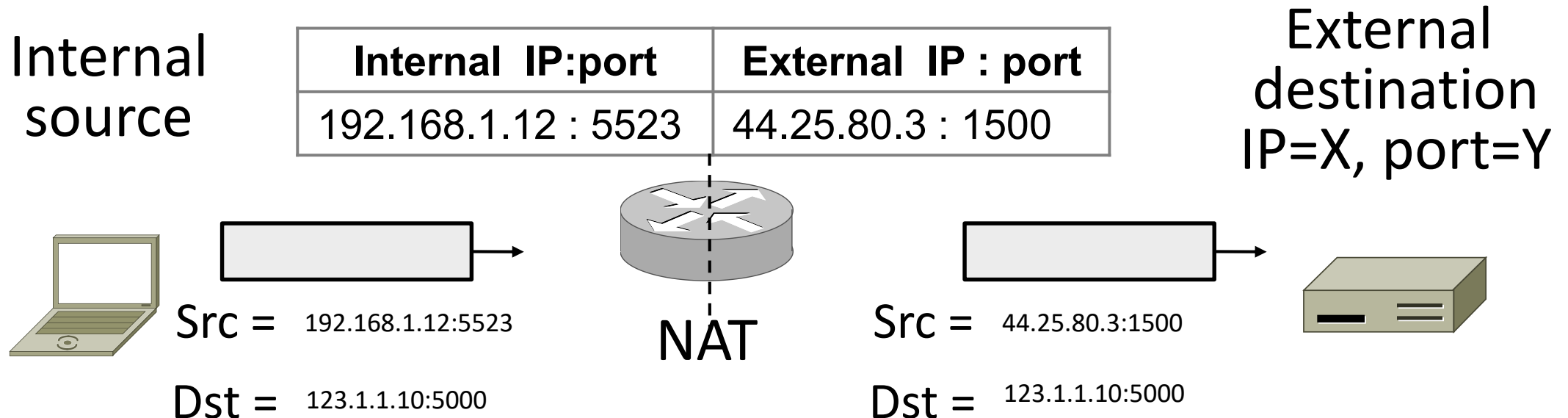

How NAT Works (3)

- External ← Internal
 - Look up and rewrite Destination IP/port

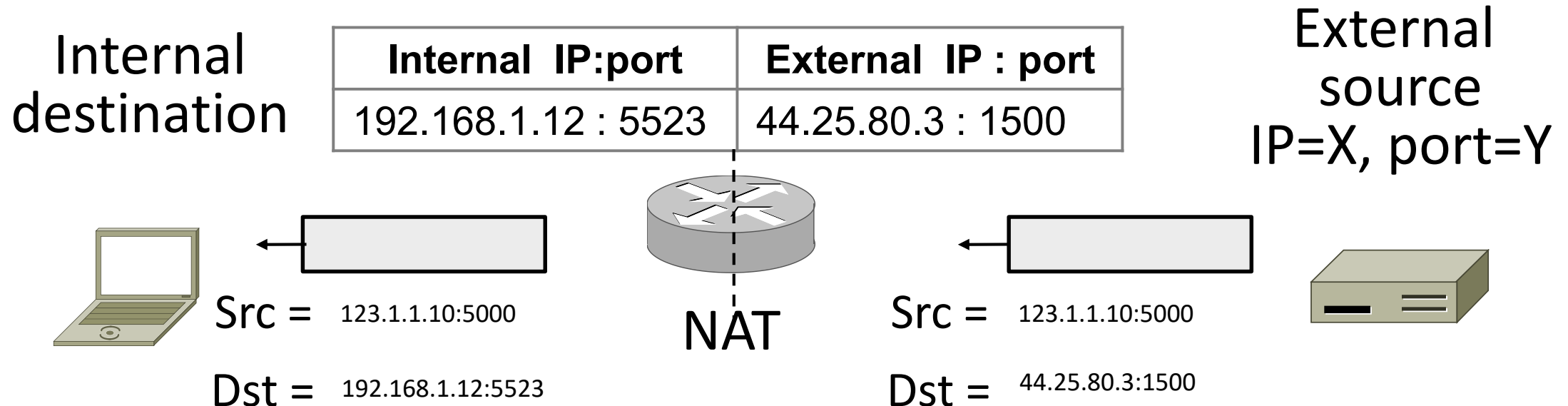

How NAT Works (4)

- Need to enter translations in the table for it to work
 - Create external name when host makes a TCP connection

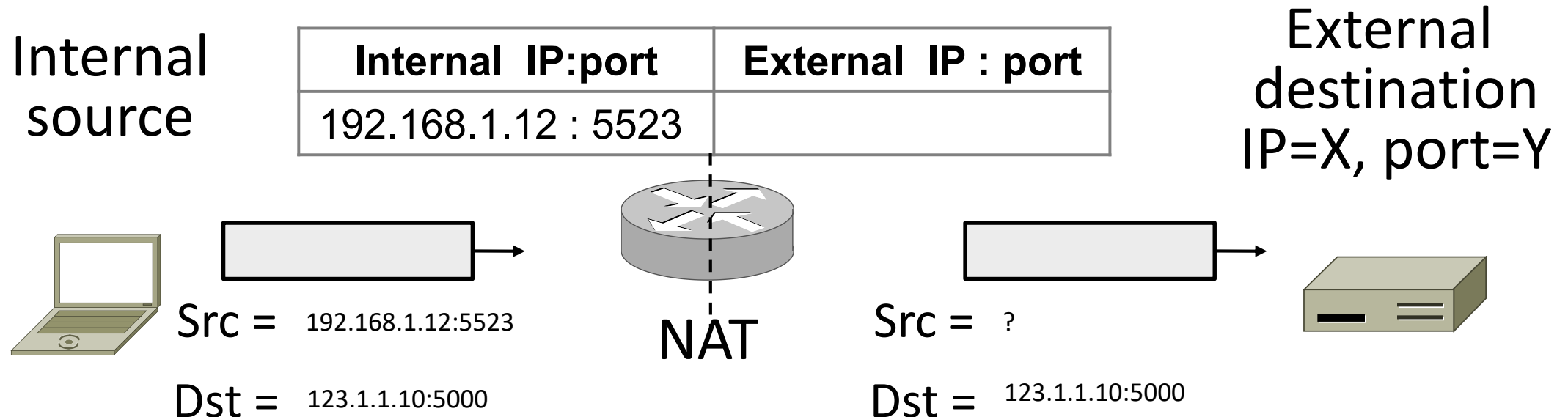

How NAT Works (5)

- What happens when a message arrives for an internal source without a table entry?

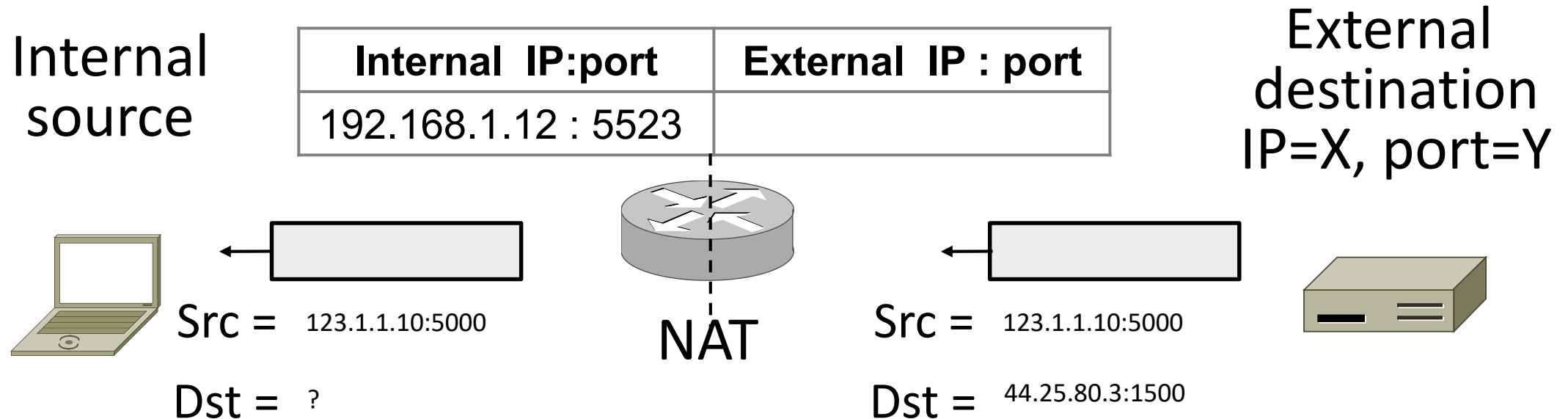

NAT Downsides

- Connectivity has been broken!
 - Can only send incoming packets after an outgoing connection is set up
 - Difficult to run servers or peer-to-peer apps (Skype)
- Doesn't work when there are no connections (UDP)
- Breaks apps that expose their IP addresses (FTP)

NAT Upsides

- Relieves much IP address pressure
 - Many home hosts behind NATs
- Easy to deploy
 - Rapidly, and by you alone
- Useful functionality
 - Firewall, helps with privacy
- Kinks will get worked out eventually
 - “NAT Traversal” for incoming traffic

IPv6

Problem: Internet Growth

- Many billions of hosts
- And we're using 32-bit addresses!

Internet Domain Survey Host Count

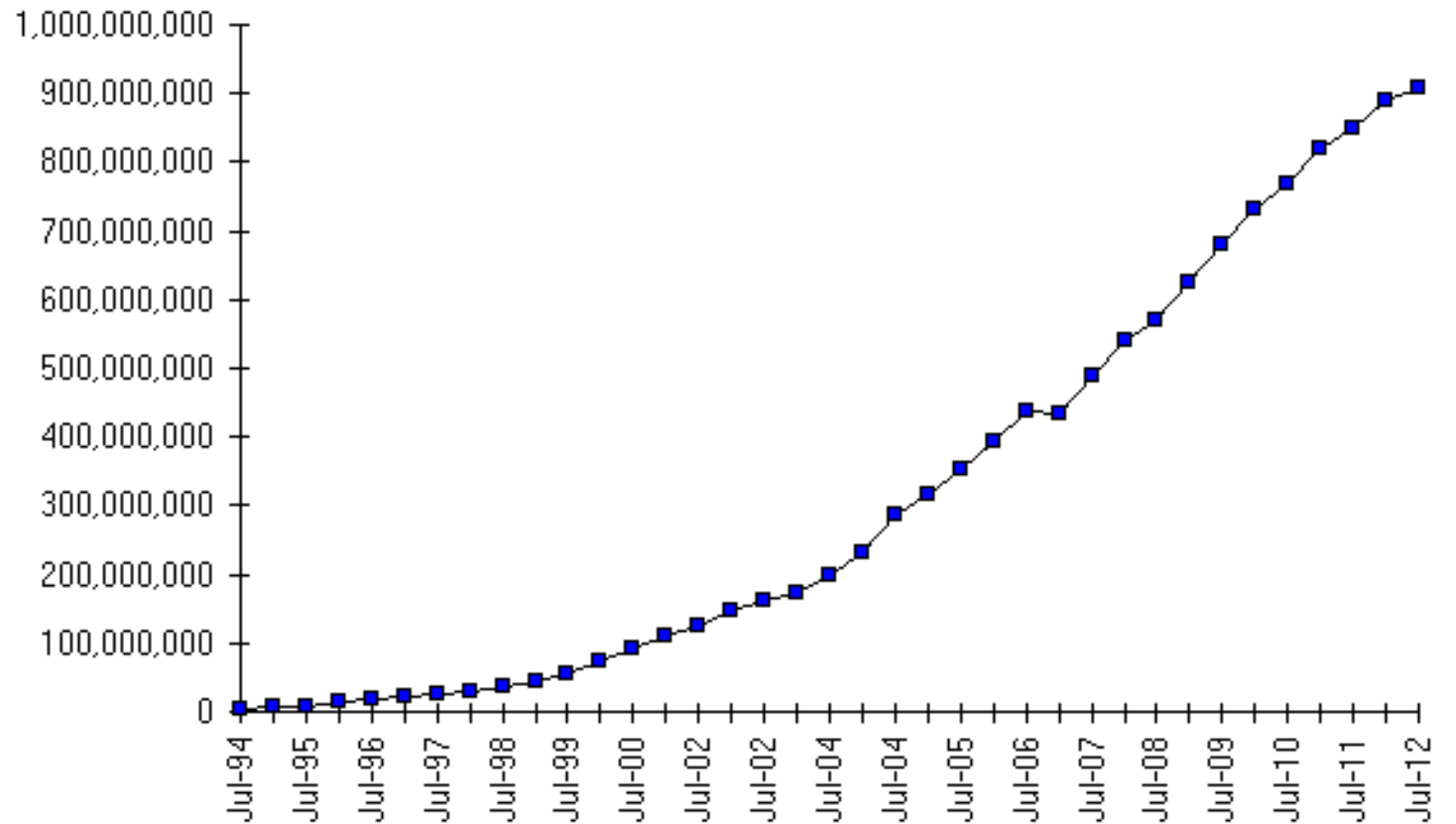

Source: Internet Systems Consortium (www.isc.org)

IP Version 6 to the Rescue

- Effort started by the IETF in 1994
 - Much larger addresses (128 bits)
 - Many sundry improvements
- Became an IETF standard in 1998
 - Nothing much happened for a decade
 - Hampered by deployment issues, and a lack of adoption incentives
 - Big push ~2011 as exhaustion loomed

IPv6

- Features large addresses
 - 128 bits, most of header
- New notation
 - 8 groups of 4 hex digits (16 bits)
 - Omit leading zeros, groups of zeros

Ex: 2001:0db8:0000:0000:0000:ff00:0042:8329
→ 2001:db8::ff00:42:8329

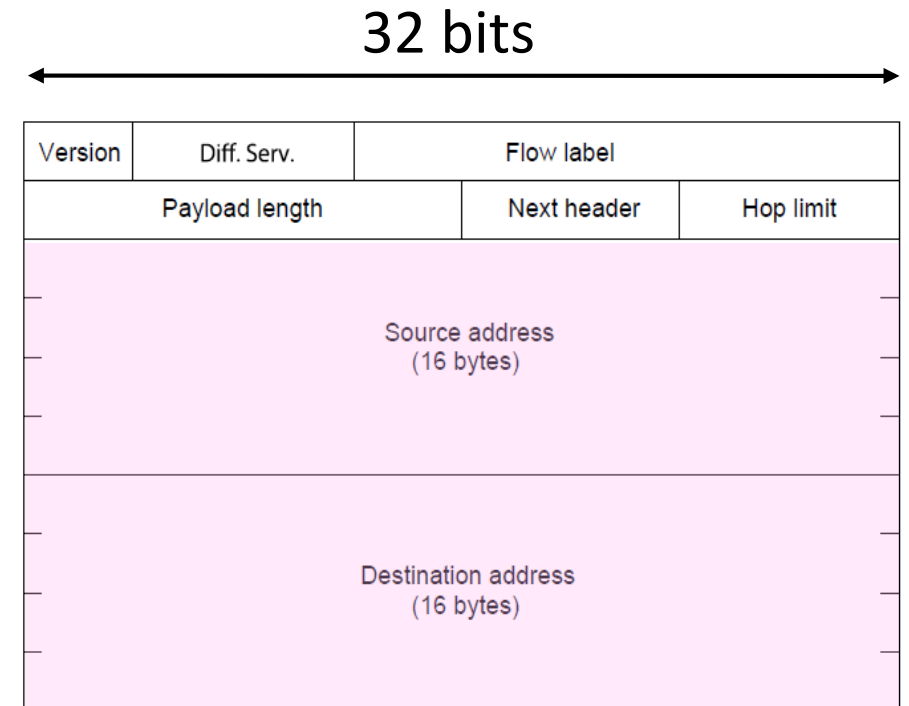

IPv6 (2)

- Lots of other changes
 - Only public addresses
 - No more NAT!
 - Streamlined header processing
 - No checksum (why's that faster?)
 - Flow label to group of packets
 - IPSec by default
 - Better fit with “advanced” features (mobility, multicasting, security)

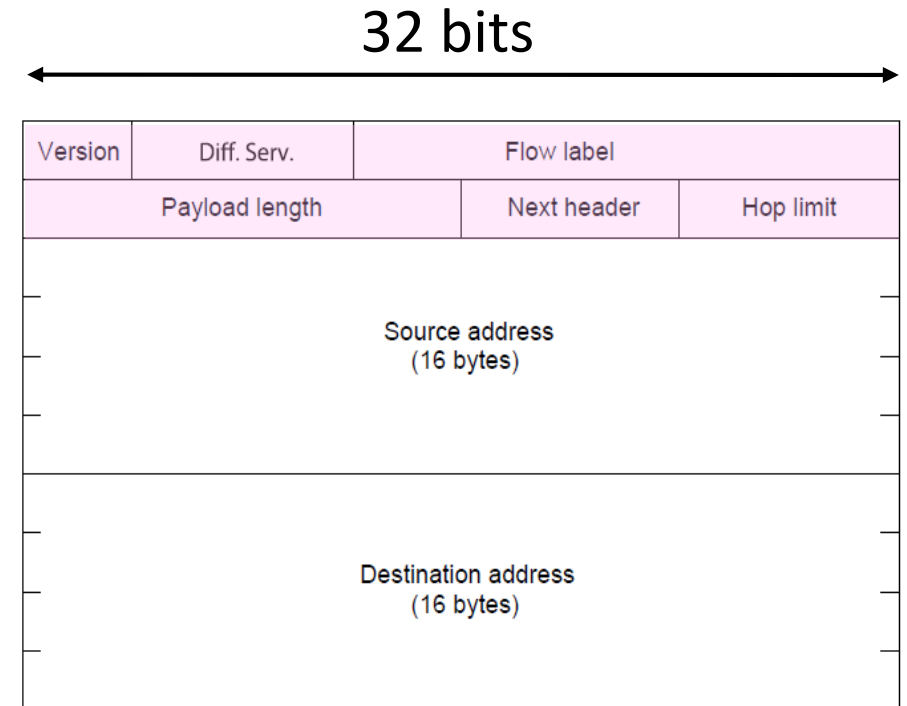

IPv6 (3)

- Does this fix ARP?
- Does this fix DHCP?
- Does this fix NAT?

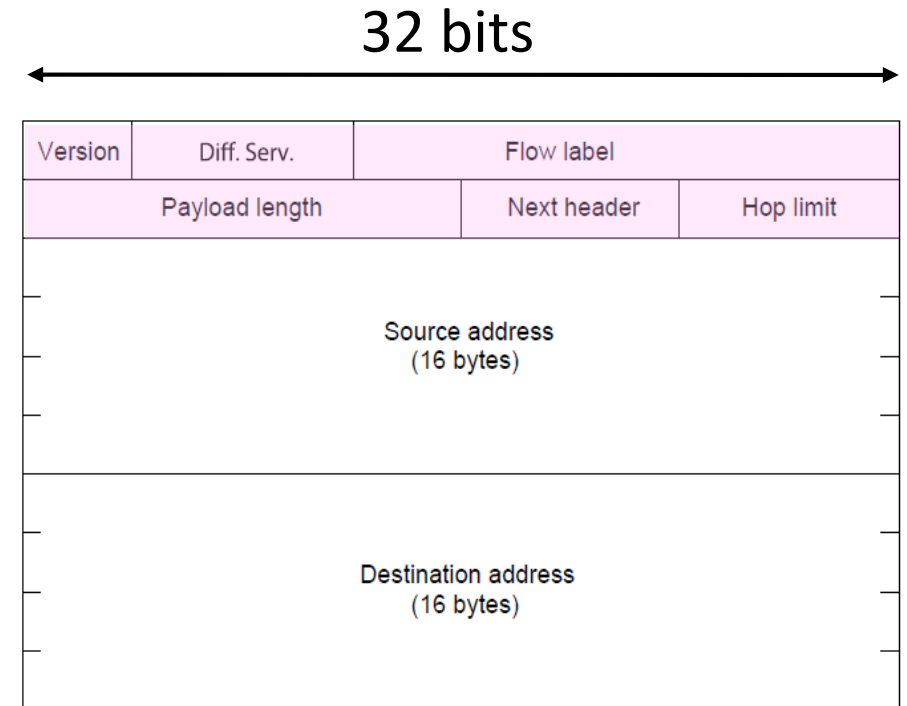

IPv6 (3)

- Does this fix ARP? No: NDP
- Does this fix DHCP? No: SLAAC
- Does this fix NAT? Yes!

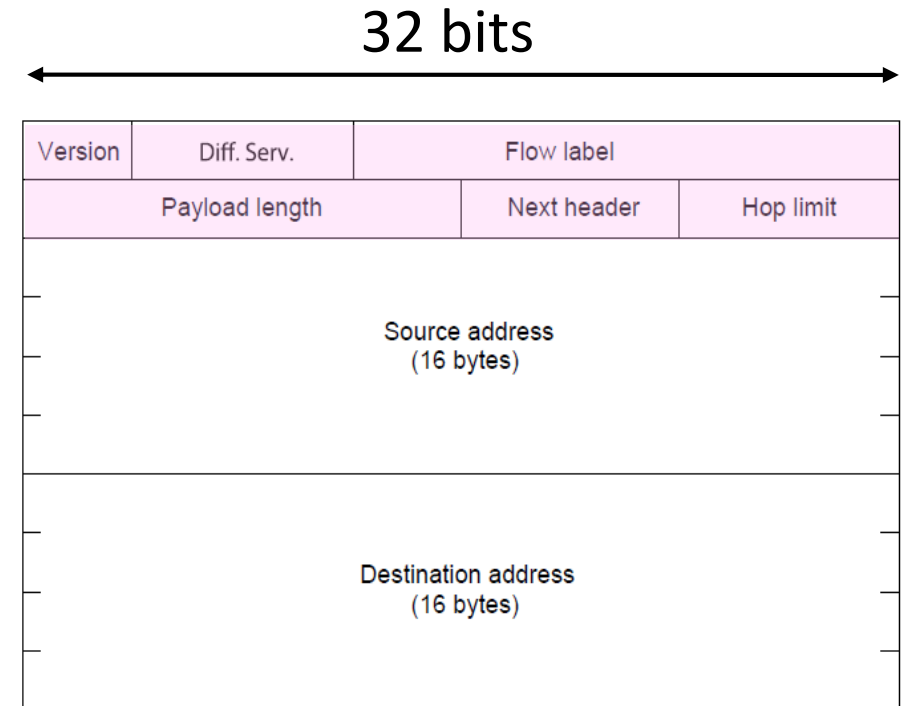

Neighbor Discovery Protocol

- Uses ICMPv6
- DHCP Functions:
 - Router discovery (133)/advertisement (134)
- ARP Functions:
 - Neighbor discovery (135)/advertisement (136)

Stateless Autoconfiguration (SLAAC)

- Replaces DHCP (sorta...)
- Uses ICMPv6
- Process:
 - Send broadcast message
 - Get prefix from router
 - Attach MAC to router Prefix /w some math
 - 48 bit → EUI-64 format

Address: 2000:1234:5678::1001/64
Prefix: 2000:1234:5678:: /64

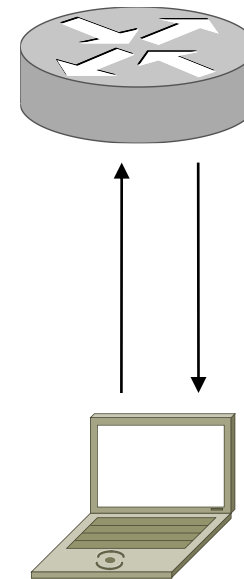

MAC: 0200:1234:5678 → 0000:12FF:FE34:5678
Address: 2000:1234:5678::12FF:FE34:5678

IPv6 Transition

- The Big Problem:
 - How to deploy IPv6?
 - Fundamentally incompatible with IPv4
- Dozens of approaches proposed
 - Dual stack (speak IPv4 and IPv6)
 - Translators (convert packets)
 - Tunnels (carry IPv6 over IPv4)

Tunneling

- Native IPv6 islands connected via IPv4
 - Tunnel carries IPv6 packets across IPv4 network

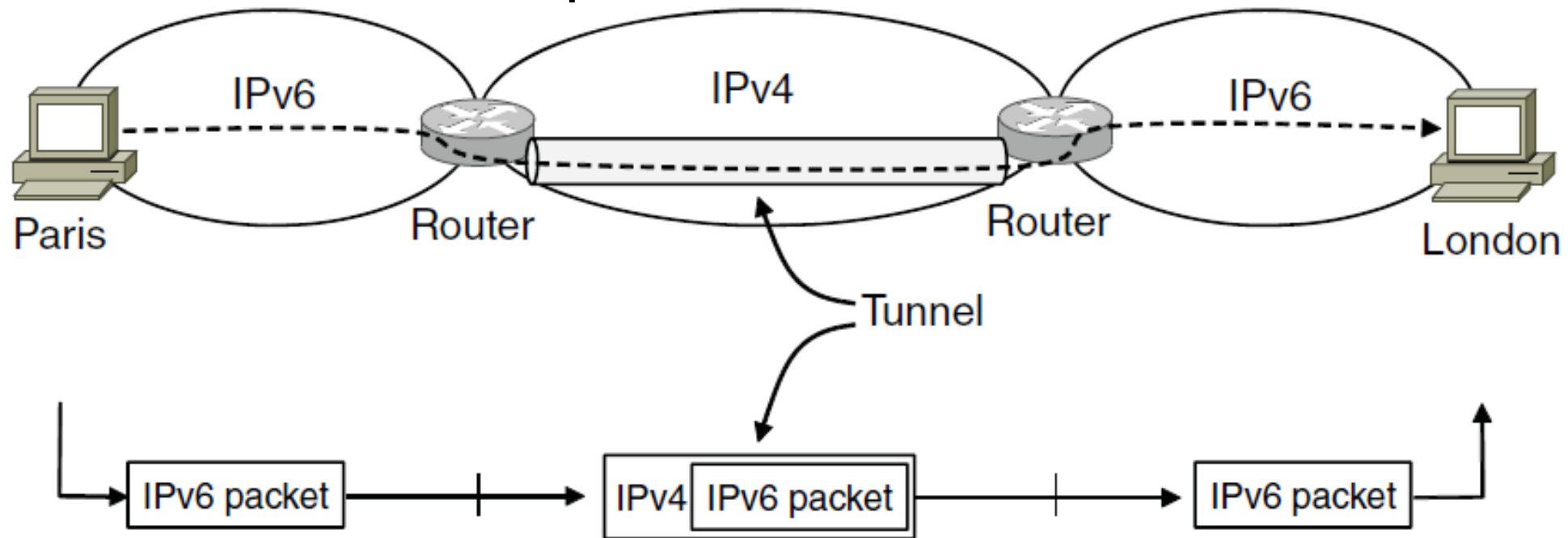

Tunneling (2)

- Tunnel acts as a single link across IPv4 network

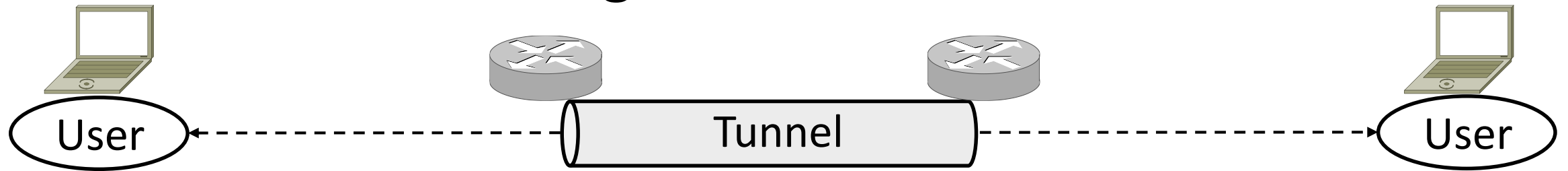

Tunneling (3)

- Tunnel acts as a single link across IPv4 network
 - Difficulty is to set up tunnel endpoints and routing

