

CSE 474 – Introduction to Embedded Systems

- Instructor:

- Bruce Hemingway
 - CSE 464, Office Hours: 11:00-12:00 p.m., Tuesday, Thursday
 - or whenever the door is open
 - bruceh@cs.washington.edu

- Teaching Assistants:

- Cody Ohlsen, Kendall Lowrey and Ying-Chao (Tony) Tung

CSE 474 – Software for Embedded Systems

- Class Meeting Times and Location:

- Lectures: EEB 037, TTh 2:30-4:20
- Labs: EEB 345, 24/7 access

- Exams

- Midterm: Tuesday, Feb. 7, EEB 037, 2:30-4:20
- Final: Tuesday, March 14, 2017, 4:30-6:20 pm, EEB 037

CSE 474 – Software for Embedded Systems

■ Grading Policy

- There will be two exams, as shown on the class schedule.
- Lab reports: Demo usually required, sometimes questions

■ Ratios:

- Lab: 40%
- Exams total: 40%
- Class Participation: 20%

Recommended Textbook (not required):

The Definitive Guide to ARM® Cortex®-M3 and Cortex®-M4 Processors, Third Edition

By Joseph Yiu

Newnes; 3 edition (November 1,
2013)

U Bookstore doesn't have it.

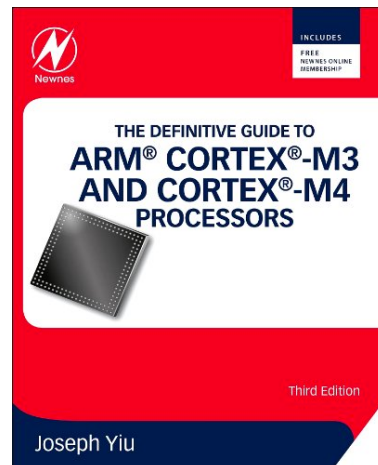

Other Textbook (not required):

- **Embedded Systems: A Contemporary Design Tool**
Paperback – 2009

- by James K Peckol

U Bookstore has used hardback.

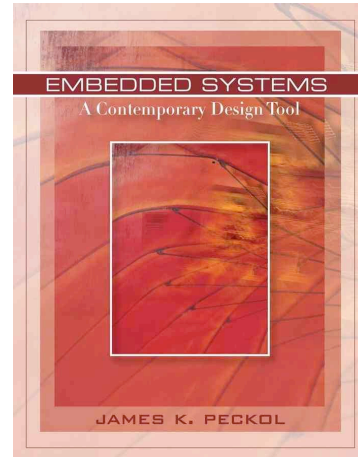

Embedded systems



Embedded systems

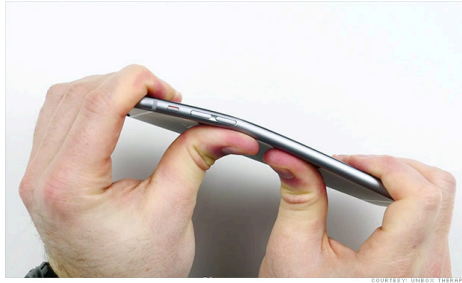

What are Embedded Systems?

- Anything that uses a microprocessor but isn't a general-purpose computer
 - Smartphones
 - Set-top boxes
 - Televisions
 - Video Games
 - Refrigerators
 - Cars
 - Planes
 - Elevators
 - Remote Controls
 - Alarm Systems
- The user “sees” a smart (special-purpose) system as opposed to the computer inside the system
 - “how does it do that?”
 - “it has a computer inside it!”
 - “oh! BTW, it does not or cannot run Windows or MacOS!”
- the end-user typically does not or cannot modify or upgrade the internals

What Are You Going to Learn?

- **Hardware**
 - I/O, memory, busses, devices, control logic, interfacing hardware to software
- **Software**
 - Lots of C and assembly, device drivers, low level real-time issues, scheduling,
 - Concurrency: interrupts
- **Software/Hardware interactions**
 - Where is the best place to put functionality hardware or software?
 - What are the costs:
 - performance,
 - memory requirements (RAM and/or FLASH ROM)
- **Integration of hardware and software courses**
 - Programming, logic design, architecture,
 - Algorithms, mathematics and *common sense*

Where Could *You* End Up?

- Automotive systems
 - perhaps designing and developing “drive-by-wire” systems
 - self-driving vehicles
- Telecommunications
- Consumer electronics
 - cellular phones, MP3 devices, integrated cellular/tablet/kitchen sink
 - Set-top boxes and HDTV
 - Home appliances
 - Internet appliances
 - your washer will be on the internet more than you are!
- Defense and weapon systems
- Process control
 - gasoline processing, chemical refinement
- Automated manufacturing
 - Supervisory Control and Data Acquisition (SCADA)
- Space applications
 - Satellite communications

Goals of the Course

■ High-Level Goals

1. Understand the scientific principles and concepts behind embedded systems, and
2. Obtain hands-on experience in programming embedded systems.

By the end of the course, you should be able to

- Understand the "big ideas" in embedded systems
- Obtain direct hands-on experience on both hardware and software elements commonly used in embedded system design.
- Understand the basics of embedded system application concepts such as signal processing and feedback control
- Understand, and be able to discuss and communicate intelligently about
 - embedded processor architecture and programming
 - I/O and device driver interfaces to embedded processors with networks, multimedia cards and disk drives
 - OS primitives for concurrency, timeouts, scheduling, communication and synchronization

The Big Ideas

- HW/SW Boundary
- Non processor centric view of architecture
- Bowels of the operating software
 - specifically, basic real-time operation with interrupts
 - Concurrency
- Real-world design
 - performance vs. cost tradeoffs
- Analyzability
 - how do you "know" that your drive-by-wire system will function correctly?
- Application-level techniques
 - signal processing, control theory
 - semaphores, locks, atomic sections

What is an Embedded System?

- Computer purchased as part of some *other* piece of equipment
 - Typically dedicated software (may be user customizable)
 - Often replaces previously electromechanical components
 - Often no “real” keyboard
 - Often limited display or no general purpose display device
- But, every system is unique there are always exceptions

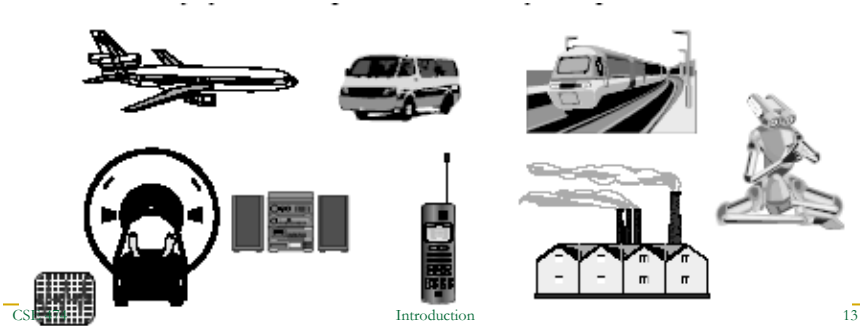

CPU: An All-Too-Common View of Computing

- Measured by:
 - Performance

CPU

An Advanced Computer Engineer's View

- Measured by: Performance
 - Compilers matter too...

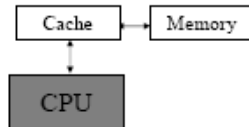

An Enlightened Computer Engineer's View

- Measured by: Performance, Cost
 - Compilers & OS matters

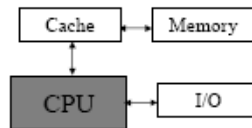

An Embedded Computer Designer's View

- Measured by: Cost, I/O connections, Memory Size, Performance

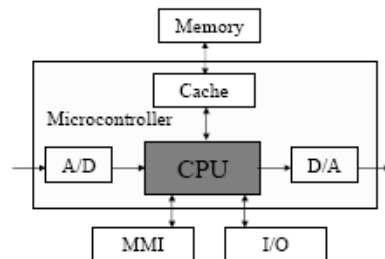

An Embedded Control System Designer's View

- Measured by:
Cost, Time to market, Cost, Functionality, Cost & Cost.

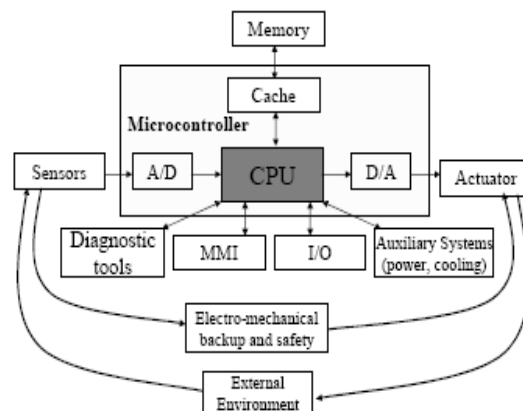

A Customer View

- Reduced Cost
- Increased Functionality
- Improved Performance
- Increased Overall Dependability



Why Are Embedded Systems Different?

Four General Categories of Embedded Systems

- General Computing
 - Applications *similar* to desktop computing, but in an embedded package
 - Video games, settop boxes, wearable computers, automatic tellers
 - Tablets, Phablets
- Control Systems
 - Closed loop feedback control of real time system
 - Vehicle engines, chemical processes, nuclear power, flight control
- Signal Processing
 - Computations involving large data streams
 - Radar, Sonar, video compression
- Communication & Networking
 - Switching and information transmission
 - Telephone system, Internet
 - Wireless everything



Typical Embedded System Constraints

- Small Size, Low Weight
 - Handheld electronics
 - Transportation applications weight costs money
- Low Power
 - Battery power for 8+ hours (laptops often last only 2 hours)
 - Limited cooling may limit power even if AC power available
- Harsh environment
 - Heat, vibration, shock
 - Power fluctuations, RF interference, lightning
 - Water, corrosion, physical abuse
- Safety critical operation
 - Must function correctly
 - Must not function incorrectly
- Extreme cost sensitivity
 - \$.05 adds up over 1,000,000 units



Embedded System Design World-View

A complex set of tradeoffs:

- Optimize for ***more than just speed***
- Consider ***more than just the computer***
- Take into account ***more than just initial product design***

Multi-Discipline

- Electronic Hardware
- Software
- Mechanical Hardware
- Control Algorithms
- Humans
- Society/Institutions

X

MultiPhase

- Requirements
- Design
- Manufacturing
- Deployment
- Logistics
- Retirement

X

MultiObjective

- Dependability
- Affordability
- Safety
- Security
- Scalability
- Timeliness

Embedded System Designer Skill Set

- Appreciation for multidisciplinary nature of design
 - Both hardware & software skills
 - Understanding of engineering beyond digital logic
 - Ability to take a project from specification through production
- Communication & teamwork skills
 - Work with other disciplines, manufacturing, marketing
 - Work with customers to understand the real problem being solved
 - Make a good presentation; even better write ``trade rag" articles
- And, by the way, technical skills too...
 - Low-level: Microcontrollers, FPGA/ASIC, assembly language, A/D, D/A
 - High-level: Object oriented Design, C/C++, Real Time Operating Systems
 - Meta-level: Creative solutions to highly constrained problems
 - Likely in the future: **Unified Modeling Language**, embedded networks

Class logistics – see course web

- <https://courses.cs.washington.edu/courses/cse474/17wi/>
- Class structure
- Business matters
- Grading
- Syllabus
- What we'll be doing

Class structure

- Lecture
 - Closely linked to laboratory assignments
 - Cover main concepts, introduce laboratory problems
- Lab
 - Work leading to implementation of a final project
 - Lab reports due by end of week
- Exams
 - Two, based on lecture, lab, and datasheet reading
 - **Open datasheets, open notes**
- Final demo
 - During last class time – participation required

Business Matters

- Lecture notes will be on line after class (links on Calendar page)
- You pick lab partner assignments, or we will
- Sign up for CSE474 mailing list

Grading

- **Lab reports:**
 - Demonstration(s) required
 - Brief answers to questions embedded in assignment
 - Sometimes hand-in code
 - Do with your partner
 - Both build hardware
- **Distribution:**
 - Labs: 40%
 - Exams: 40%
 - Class Participation: 20%

CSE466 Lab Content

- **Arm Cortex M4 processor**
 - Begin with basics and build
 - Do with your lab partner
 - You can work off-site
- **Resources**
 - Freescale Arm Processor
 - 320x240 Color LCD display
 - Switch, potentiometer
 - Accelerometer with gyroscope
 - Tri-color LED, NeoPixels, Bluetooth BLE
 - Learn how to interface various devices
- **Final project**
 - Heart-rate monitor– a mini ECG
 - LCD display of heart trace
 - Measure heart rate, basic arrhythmia detection

Freescale MK20DX256VLH7 processor

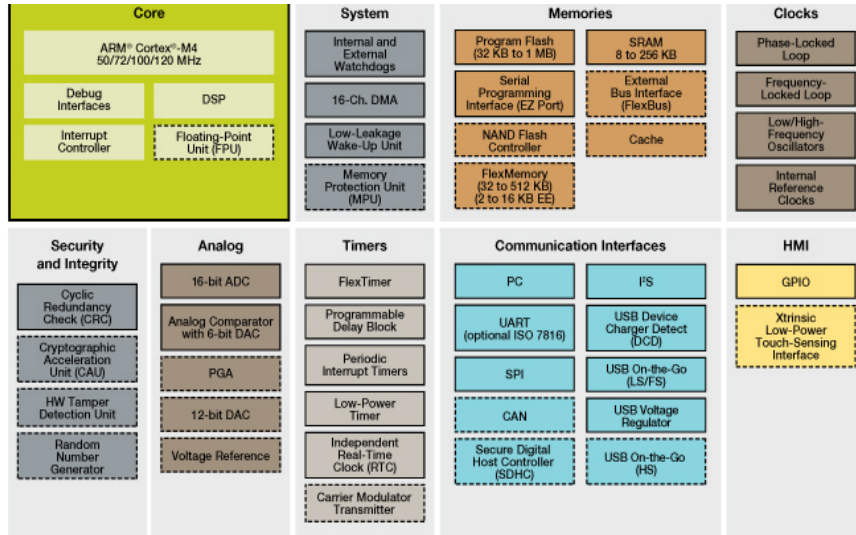

CSE 474

Introduction

29

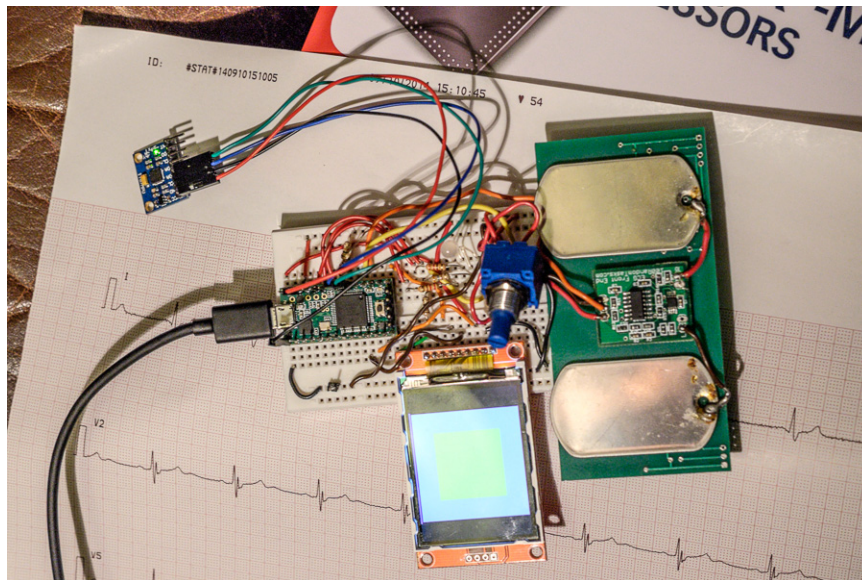

CSE 474

Introduction

30

CSE466 Labs

- Final Project – Using the Teensy 3.1
- Build a Heart Rate Monitor

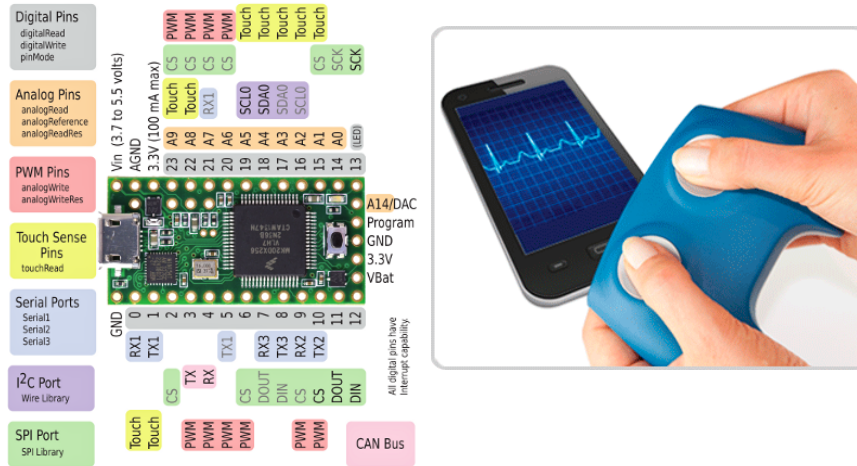

CSE 474

Introduction

31

Assignment for Thursday:

- Review the K20 Sub-Family Reference Manual *MK20DX256 Manual (8.0M PDF)*, for Teensy 3.1 (This manual has all the useful programming info)

- Chapter 2: Introduction and Functional Modules

Download here:

<https://courses.cs.washington.edu/courses/cse474/17wi/pdfs/K20P64M72SF1RM.pdf>

(link is on the Resources page...)

CSE 474

Introduction

32