

CSE 544

Parallel Databases

Tuesday, February 17th, 2011

Final Thoughts on Optimization: Parameters !

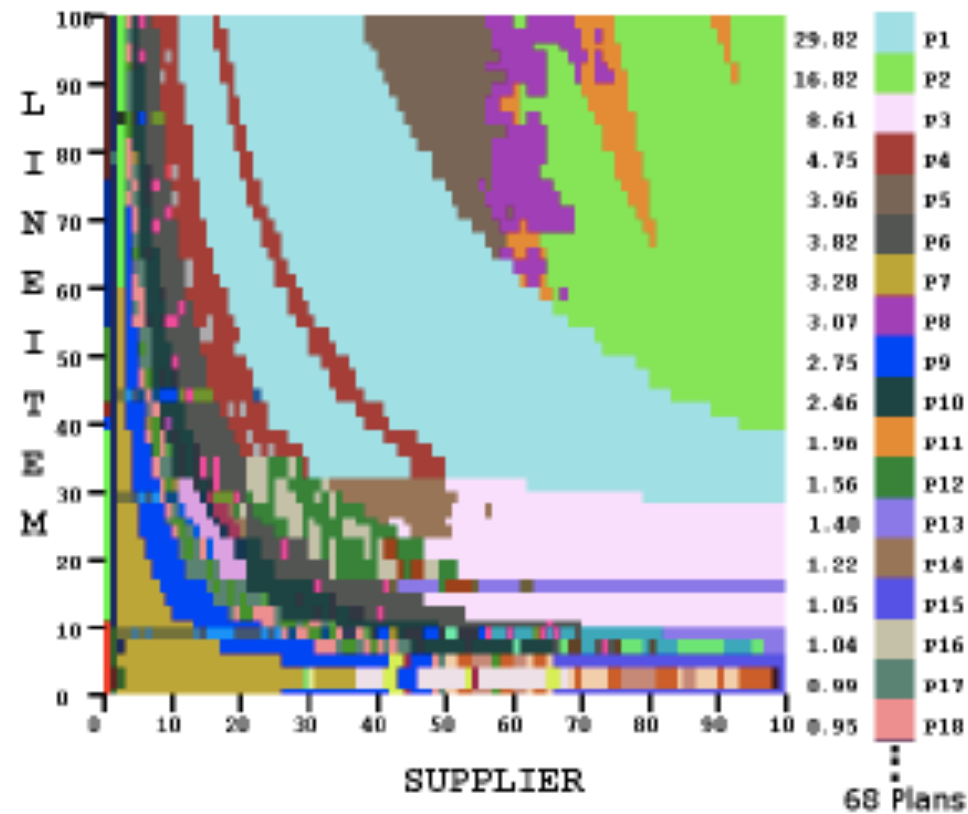

Chaudhuri "Rethinking the Contract"

Overview of Today's Lecture

- Parallel databases (Chapter 22.1 – 22.5)
- Map/reduce
- Pig-Latin
 - Some slides from Alan Gates (Yahoo! Research)

Parallel v.s. Distributed Databases

- Parallel database system:
 - Improve performance through parallel implementation
 - Will discuss in class
- Distributed database system:
 - Data is stored across several sites, each site managed by a DBMS capable of running independently
 - Will not discuss in class

Parallel DBMSs

- **Goal**
 - Improve performance by executing multiple operations in parallel
- **Key benefit**
 - Cheaper to scale than relying on a single increasingly more powerful processor
- **Key challenge**
 - Ensure overhead and contention do not kill performance

Performance Metrics for Parallel DBMSs

- **Speedup**
 - More processors → higher speed
 - Individual queries should run faster
 - Should do more transactions per second (TPS)
- **Scaleup**
 - More processors → can process more data
 - **Batch scaleup**
 - Same query on larger input data should take the same time
 - **Transaction scaleup**
 - N-times as many TPS on N-times larger database
 - But each transaction typically remains small

Linear v.s. Non-linear Speedup

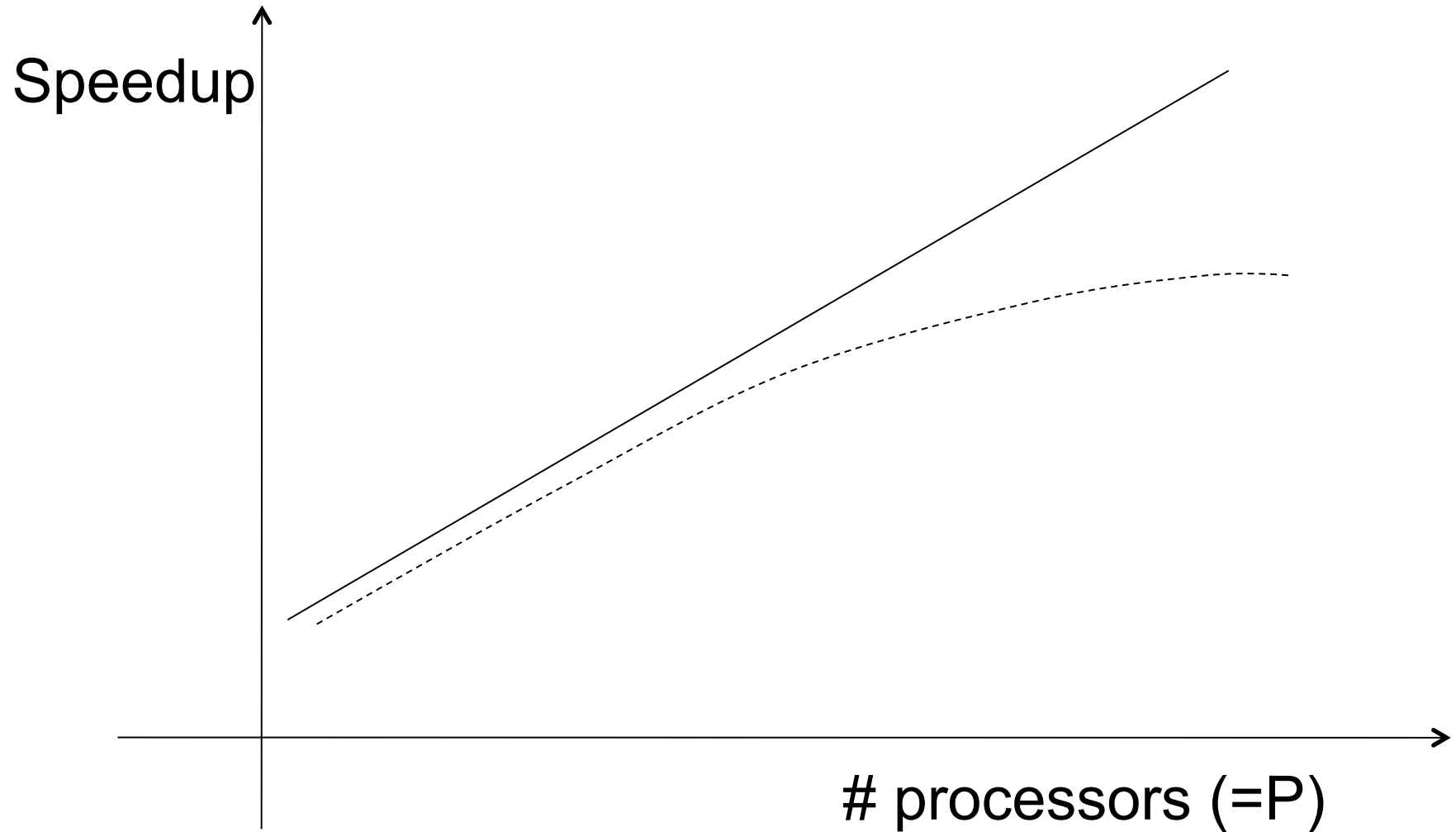

Linear v.s. Non-linear Scaleup

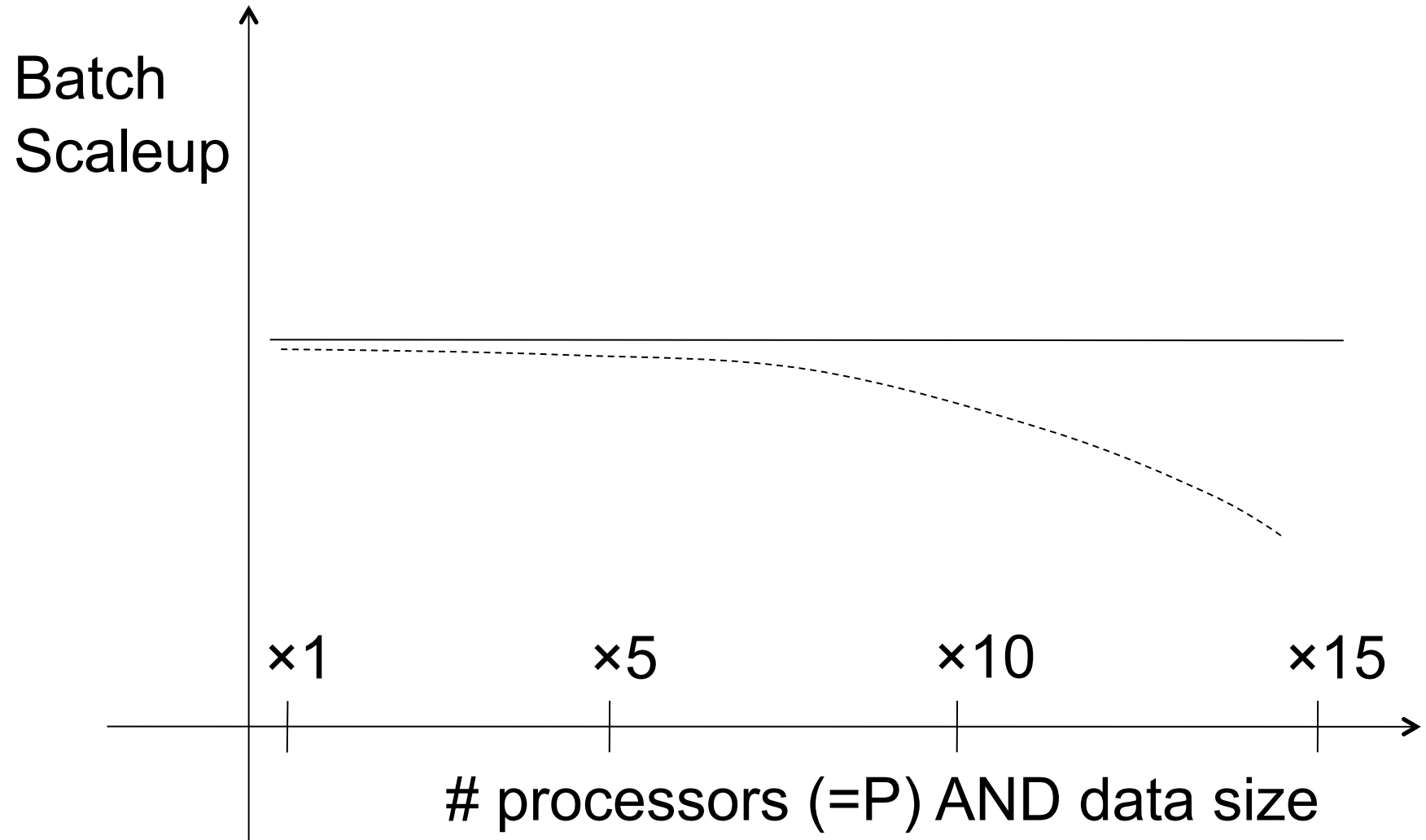

Challenges to Linear Speedup and Scaleup

- **Startup cost**
 - Cost of starting an operation on many processors
- **Interference**
 - Contention for resources between processors
- **Skew**
 - Slowest processor becomes the bottleneck

Architectures for Parallel Databases

- Shared memory
- Shared disk
- Shared nothing

Shared Memory

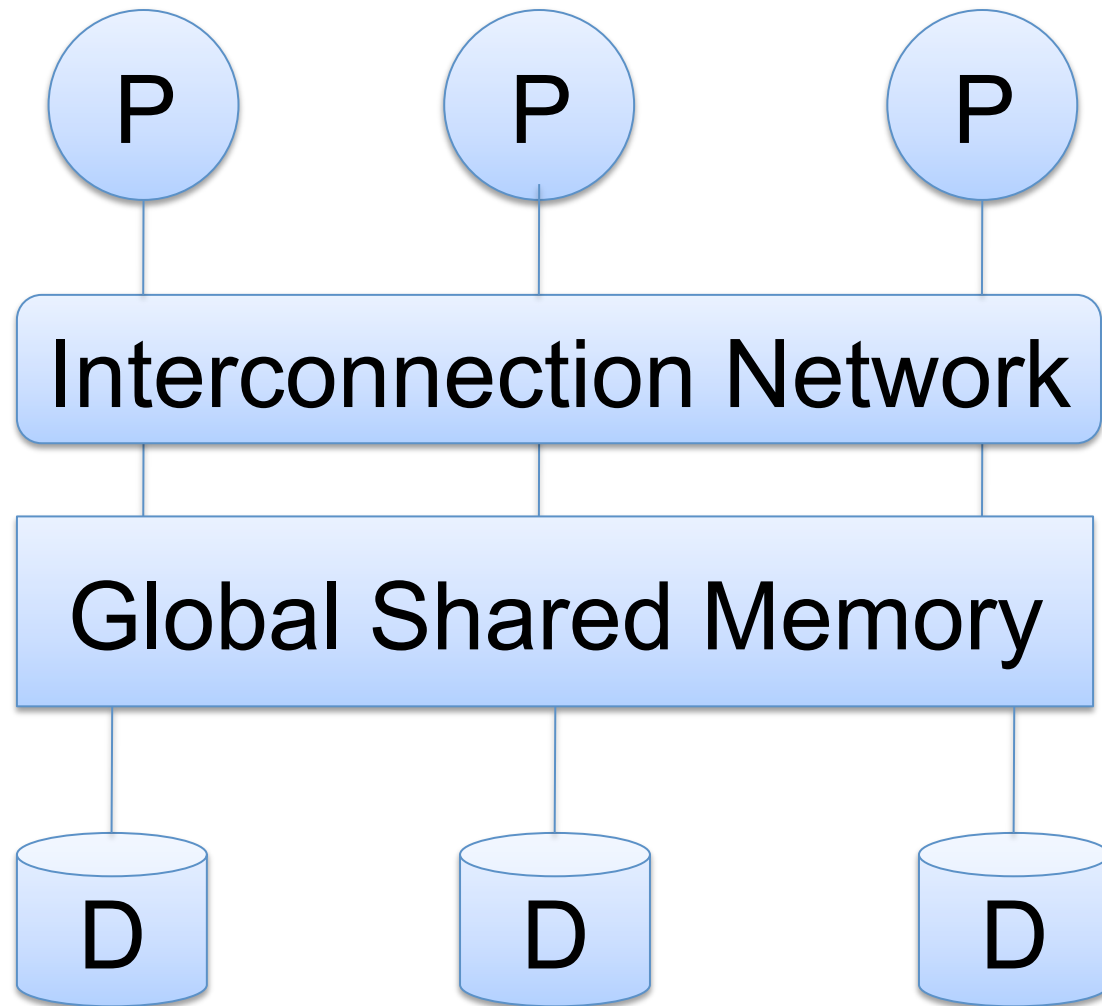

Shared Disk

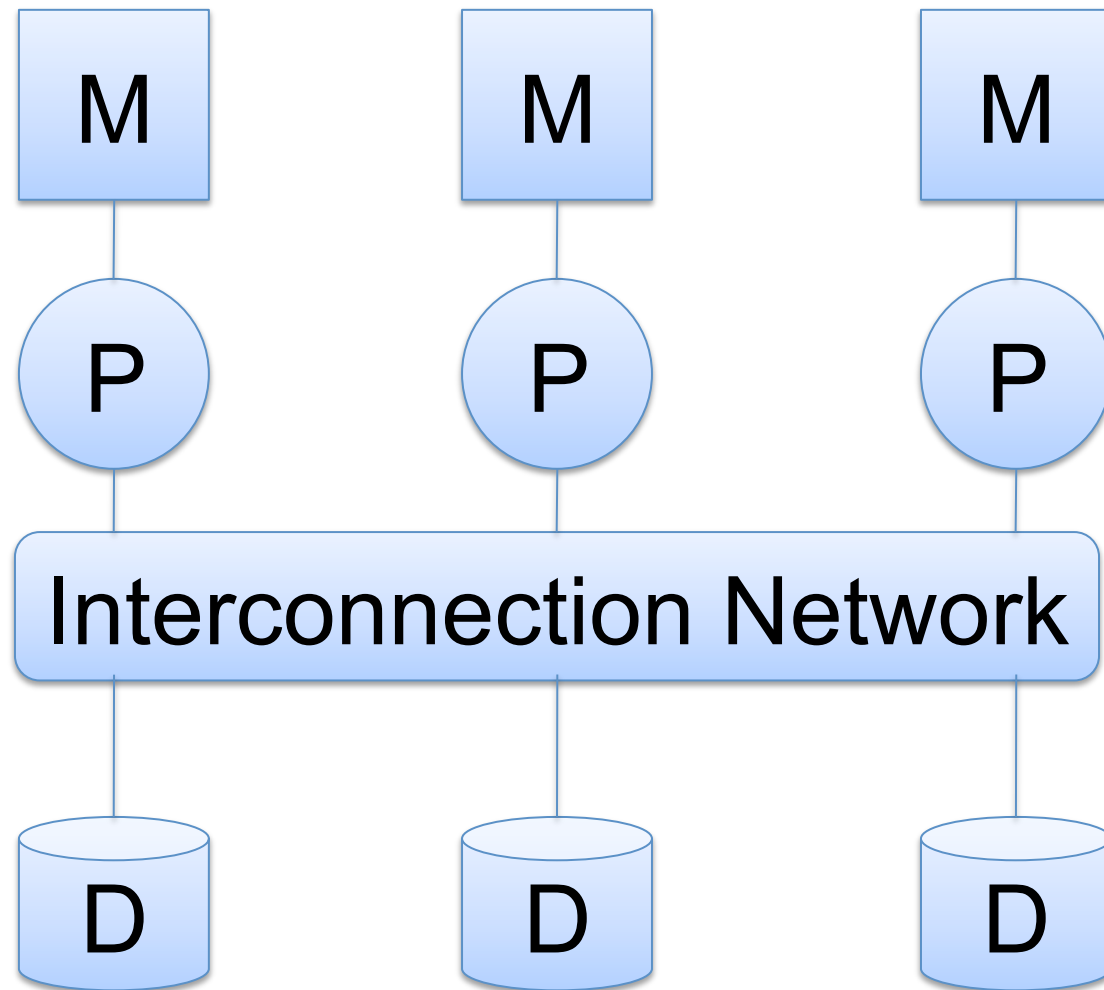

Shared Nothing

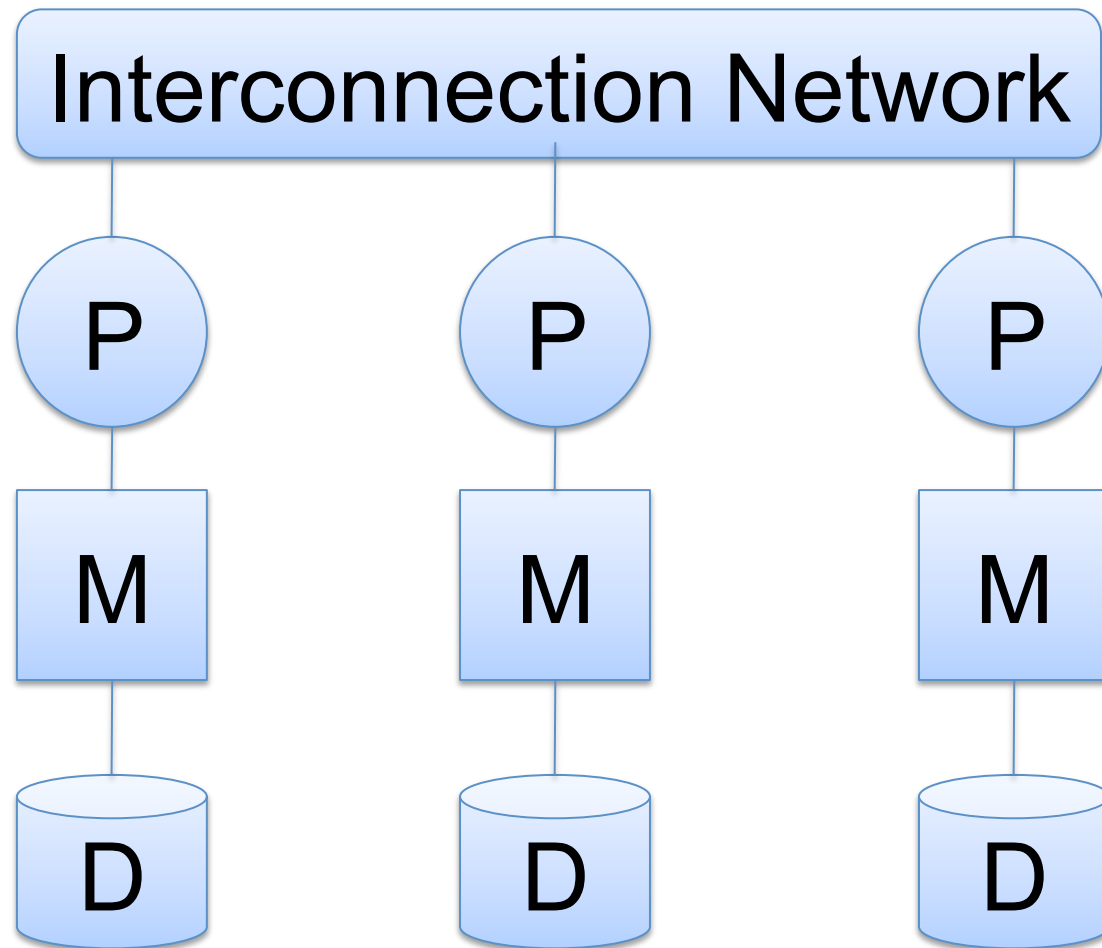

Shared Nothing

- Most scalable architecture
 - Minimizes interference by minimizing resource sharing
 - Can use commodity hardware
- Also most difficult to program and manage
- Processor = server = node
- P = number of nodes

We will focus on shared nothing

Taxonomy for Parallel Query Evaluation

- **Inter-query parallelism**
 - Each query runs on one processor
- **Inter-operator parallelism**
 - A query runs on multiple processors
 - An operator runs on one processor
- **Intra-operator parallelism**
 - An operator runs on multiple processors

We study only intra-operator parallelism: most scalable

Horizontal Data Partitioning

- Relation R split into P chunks R_0, \dots, R_{P-1} , stored at the P nodes
- **Round robin**: tuple t_i to chunk $(i \bmod P)$
- **Hash based partitioning on attribute A** :
 - Tuple t to chunk $h(t.A) \bmod P$
- **Range based partitioning on attribute A** :
 - Tuple t to chunk i if $v_{i-1} < t.A < v_i$

Parallel Selection

Compute $\sigma_{A=v}(R)$, or $\sigma_{v1 < A < v2}(R)$

- Conventional database:
 - Cost = $B(R)$
- Parallel database with P processors:
 - Cost = $B(R) / P$

Parallel Selection

Different processors do the work:

- Round robin partition: all servers do the work
- Hash partition:
 - One server for $\sigma_{A=v}(R)$,
 - All servers for $\sigma_{v1 < A < v2}(R)$
- Range partition: one server does the work

Data Partitioning Revisited

What are the pros and cons ?

- Round robin
 - Good load balance but always needs to read all the data
- Hash based partitioning
 - Good load balance but works only for equality predicates and full scans
- Range based partitioning
 - Works well for range predicates but can suffer from data skew

Parallel Group By: $\gamma_{A, \text{sum}(B)}(R)$

Step 1: server i partitions chunk R_i using a hash function $h(t.A)$: $R_{i0}, R_{i1}, \dots, R_{i,P-1}$

Step 2: server i sends partition R_{ij} to server j

Step 3: server j computes $\gamma_{A, \text{sum}(B)}$ on $R_{0j}, R_{1j}, \dots, R_{P-1,j}$

Cost of Parallel Group By

Recall conventional cost = $3B(R)$

- Step 1: Cost = $B(R)/P$ I/O operations
- Step 2: Cost = $(P-1)/P B(R)$ blocks are sent
 - Network costs \ll I/O costs
- Step 3: Cost = $2 B(R)/P$
 - When can we reduce it to 0 ?

Total = $3B(R) / P$ + communication costs

Parallel Join: $R \bowtie_{A=B} S$

Step 1

- For all servers in $[0, k]$, server i partitions chunk R_i using a hash function $h(t.A)$: $R_{i0}, R_{i1}, \dots, R_{i, P-1}$
- For all servers in $[k+1, P]$, server j partitions chunk S_j using a hash function $h(t.A)$: $S_{j0}, S_{j1}, \dots, S_{j, P-1}$

Step 2:

- Server i sends partition R_{iu} to server u
- Server j sends partition S_{ju} to server u

Steps 3: Server u computes the join of R_{iu} with S_{ju}

Cost of Parallel Join

- Step 1: Cost = $(B(R) + B(S))/P$
- Step 2: 0
 - $(P-1)/P (B(R) + B(S))$ blocks are sent, but we assume network costs to be \ll disk I/O costs
- Step 3:
 - Cost = 0 if small table fits in memory: $B(S)/P \leq M$
 - Cost = $4(B(R)+B(S))/P$ otherwise

Parallel Query Plans

- Same relational operators
- Add special split and merge operators
 - Handle data routing, buffering, and flow control
- Example: exchange operator
 - Inserted between consecutive operators in the query plan

Map Reduce

- Google: paper published 2004
- Free variant: Hadoop
- Map-reduce = high-level programming model and implementation for large-scale parallel data processing

Data Model

Files !

A file = a bag of (key, value) pairs

A map-reduce program:

- Input: a bag of (inputkey, value) pairs
- Output: a bag of (outputkey, value) pairs

Step 1: the MAP Phase

User provides the MAP-function:

- **Input:** one `(input key, value)`
- **Output:** bag of `(intermediate key, value)` **pairs**

System applies the map function in parallel to all `(input key, value)` pairs in the input file

Step 2: the REDUCE Phase

User provides the REDUCE function:

- **Input:** (intermediate key, bag of values)
- **Output:** bag of output values

System groups all pairs with the same intermediate key, and passes the bag of values to the REDUCE function

Example

- Counting the number of occurrences of each word in a large collection of

```
map(String key, String value):  
  // key: document name  
  // value: document contents  
  for each word w in value:  
    EmitIntermediate(w, "1");
```

```
reduce(String key, Iterator values):  
  // key: a word  
  // values: a list of counts  
  int result = 0;  
  for each v in values:  
    result += ParseInt(v);  
  Emit(AsString(result));
```

MAP

REDUCE

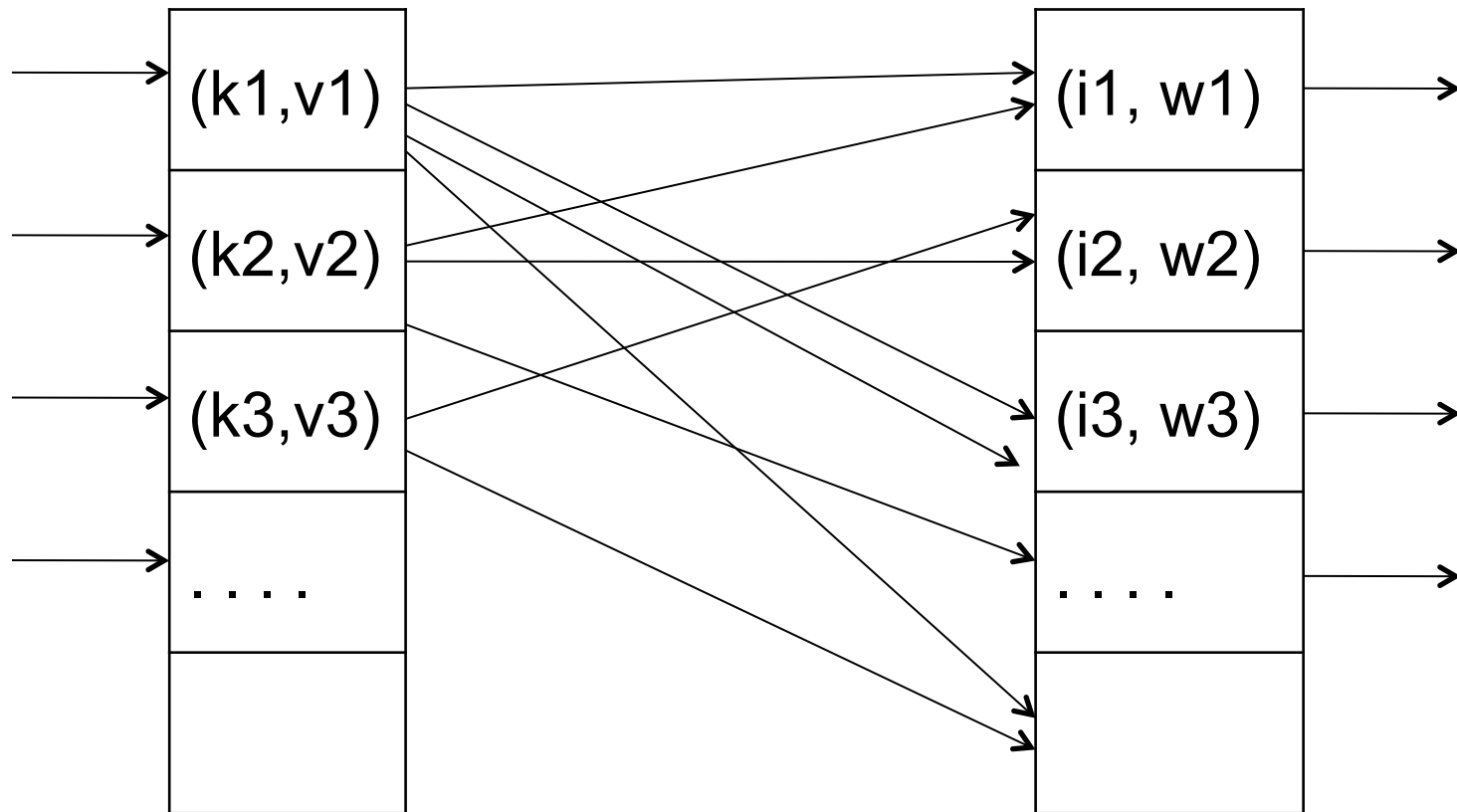

Map = GROUP BY,
Reduce = Aggregate

R(documentKey, word)

```
SELECT word, sum(1)  
FROM R  
GROUP BY word
```

Implementation

- There is one master node
- Master partitions input file into *M splits*, by key
- Master assigns *workers* (=servers) to the *M map tasks*, keeps track of their progress
- Workers write their output to local disk, partition into *R regions*
- Master assigns workers to the *R reduce tasks*
- Reduce workers read regions from the map workers' local disks

MR Phases

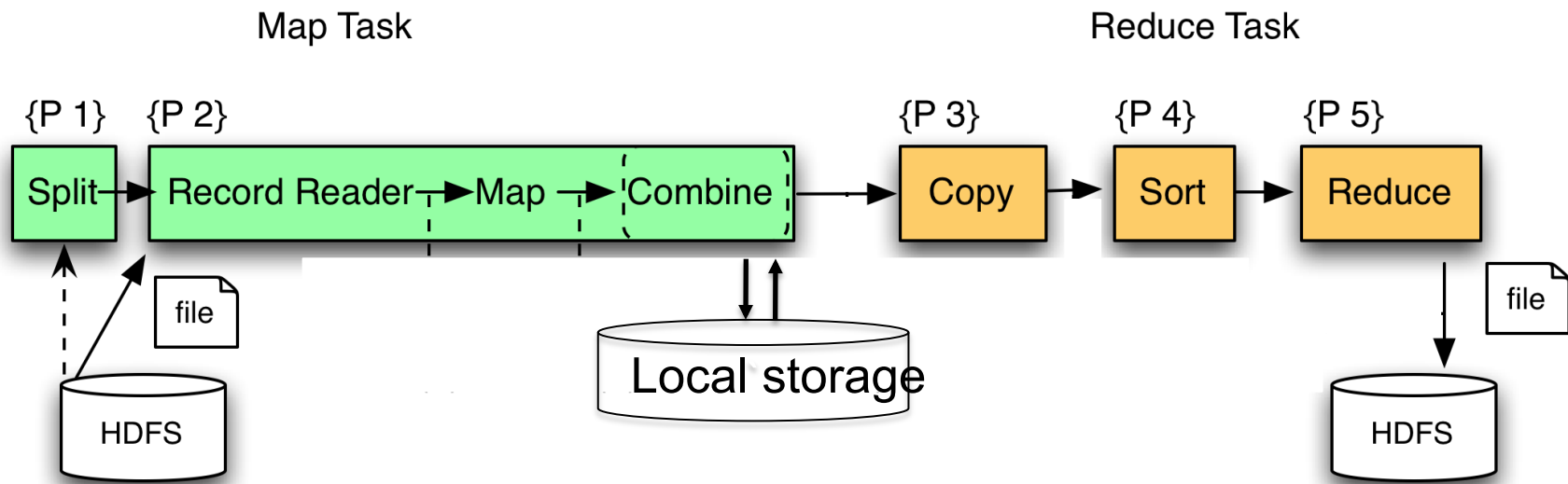

Interesting Implementation Details

- Worker failure:
 - Master pings workers periodically,
 - If down then reassigns its splits *to all other* workers → good load balance
- Choice of M and R:
 - Larger is better for load balancing
 - Limitation: master needs $O(M \times R)$ memory

Interesting Implementation Details

Backup tasks:

- *Straggler* = a machine that takes unusually long time to complete one of the last tasks.
Eg:
 - Bad disk forces frequent correctable errors (30MB/s → 1MB/s)
 - The cluster scheduler has scheduled other tasks on that machine
- Stragglers are a main reason for slowdown
- Solution: *pre-emptive backup execution of the last few remaining in-progress tasks*

Map-Reduce Summary

- Hides scheduling and parallelization details
- However, very limited queries
 - Difficult to write more complex tasks
 - Need multiple map-reduce operations
- Solution:

PIG-Latin !

Following Slides courtesy of:
Alan Gates, Yahoo!Research

What is Pig?

- An engine for executing programs on top of Hadoop
- It provides a language, Pig Latin, to specify these programs
- An Apache open source project
<http://hadoop.apache.org/pig/>

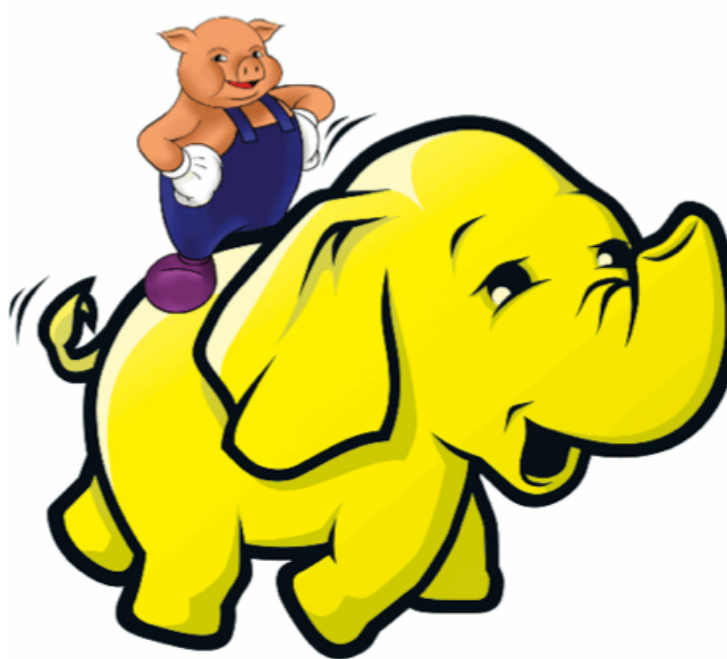

Map-Reduce

- Computation is moved to the data
- A simple yet powerful programming model
 - Map: every record handled individually
 - Shuffle: records collected by key
 - Reduce: key and iterator of all associated values
- User provides:
 - input and output (usually files)
 - map Java function
 - key to aggregate on
 - reduce Java function
- Opportunities for more control: partitioning, sorting, partial aggregations, etc.



Map Reduce Illustrated

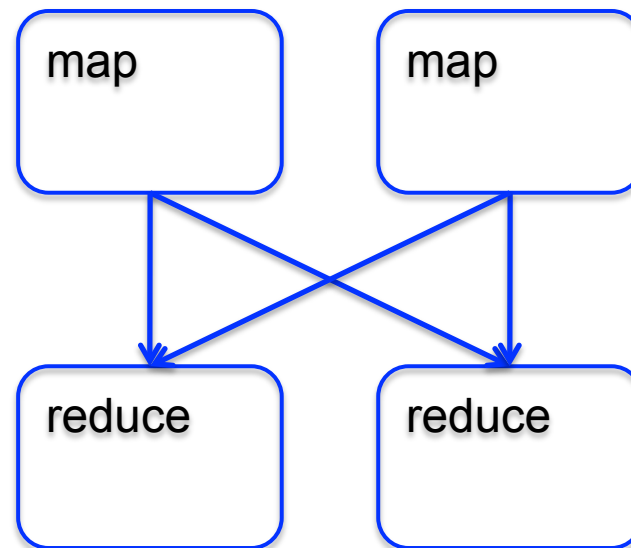

Map Reduce Illustrated

Romeo, Romeo, wherefore art thou Romeo?

What, art thou hurt?

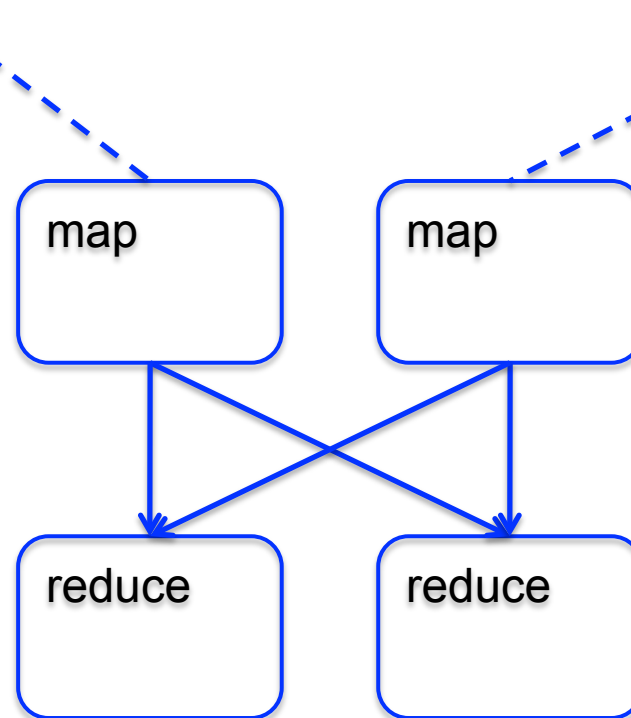

Map Reduce Illustrated

Romeo, Romeo, wherefore art thou Romeo?

What, art thou hurt?

Romeo, 1
Romeo, 1
wherefore, 1
art, 1
thou, 1
Romeo, 1

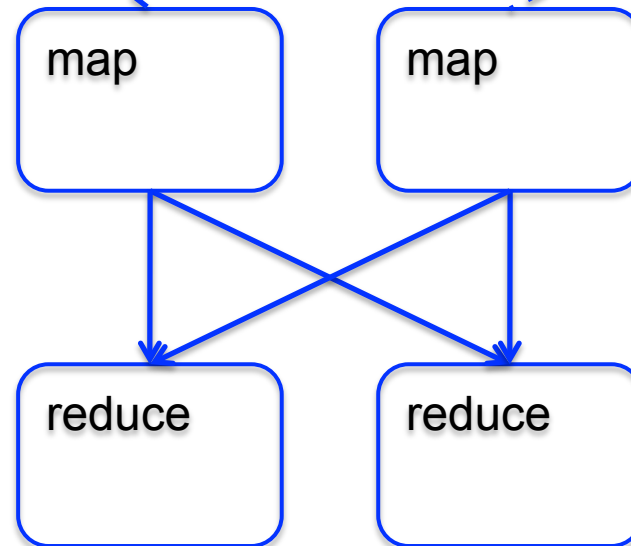

What, 1
art, 1
thou, 1
hurt, 1

Map Reduce Illustrated

Romeo, Romeo, wherefore art thou Romeo?

What, art thou hurt?

Romeo, 1
Romeo, 1
wherefore, 1
art, 1
thou, 1
Romeo, 1

art, (1, 1)
hurt (1),
thou (1, 1)

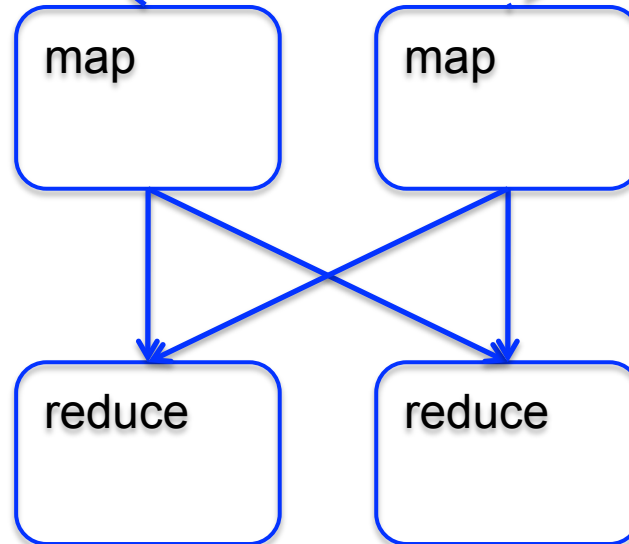

What, 1
art, 1
thou, 1
hurt, 1

Romeo, (1, 1, 1)
wherefore, (1)
what, (1)

Map Reduce Illustrated

Romeo, Romeo, wherefore art thou Romeo?

What, art thou hurt?

Romeo, 1
Romeo, 1
wherefore, 1
art, 1
thou, 1
Romeo, 1

art, (1, 1)
hurt (1),
thou (1, 1)

art, 2
hurt, 1
thou, 2

map

reduce

map

reduce

What, 1
art, 1
thou, 1
hurt, 1

Romeo, (1, 1, 1)
wherefore, (1)
what, (1)

Romeo, 3
wherefore, 1
what, 1

Making Parallelism Simple

- Sequential reads = good read speeds
- In large cluster failures are guaranteed; Map Reduce handles retries
- Good fit for batch processing applications that need to touch all your data:
 - data mining
 - model tuning
- Bad fit for applications that need to find one particular record
- Bad fit for applications that need to communicate between processes; oriented around independent units of work



Why use Pig?

Suppose you have user data in one file, website data in another, and you need to find the top 5 most visited sites by users aged 18 - 25.

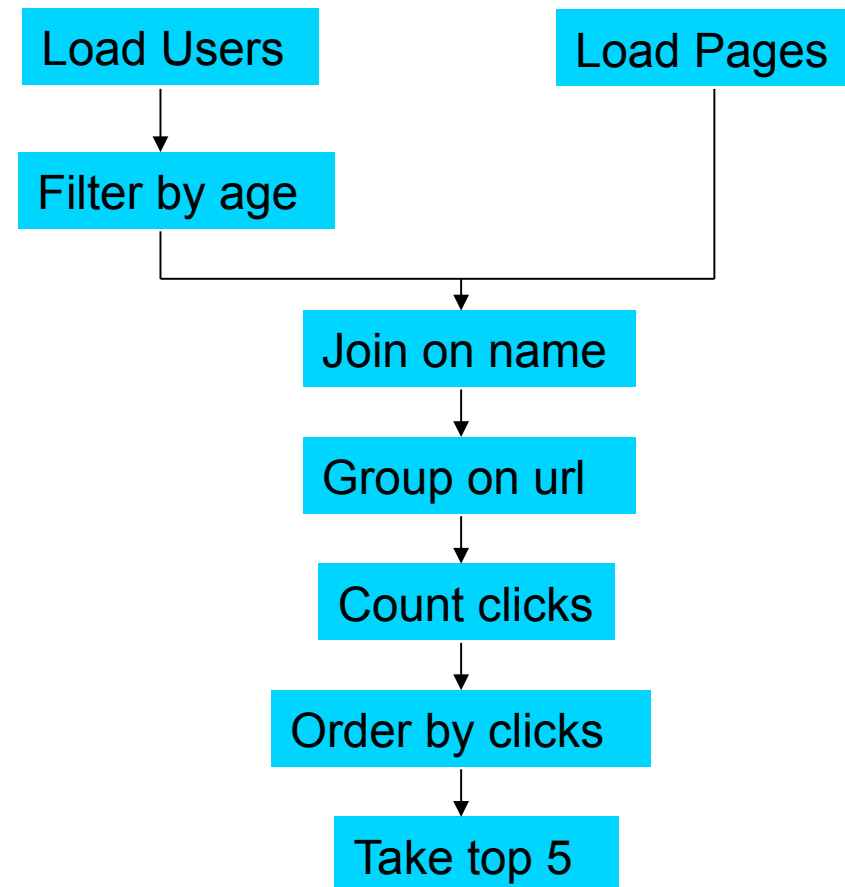

In Map-Reduce

```
import java.io.IOException;
import java.util.ArrayList;
import java.util.Iterator;
import java.util.List;

import org.apache.hadoop.fs.Path;
import org.apache.hadoop.io.LongWritable;
import org.apache.hadoop.io.Text;
import org.apache.hadoop.mapred.JobConf;
import org.apache.hadoop.mapred.KeyValueTextInputFormat;
import org.apache.hadoop.mapred.Mapper;
import org.apache.hadoop.mapred.Mapper.Recorder;
import org.apache.hadoop.mapred.MapReduceBase;
import org.apache.hadoop.mapred.Mapper.Reducer;
import org.apache.hadoop.mapred.Reporter;
import org.apache.hadoop.mapred.SequenceFileInputFormat;
import org.apache.hadoop.mapred.SequenceFileOutputFormat;
import org.apache.hadoop.mapred.TextInputFormat;
import org.apache.hadoop.mapred.JobControl;
import org.apache.hadoop.mapred.JobControl.JobConf;
import org.apache.hadoop.mapred.lib.IdentityMapper;

public class MRExample {
    public static class LoadPages extends MapReduceBase
        implements Mapper<LongWritable, Text, Text, Text> {
        public void map(LongWritable k, Text val,
            OutputCollector<Text, Text> oc,
            Reporter reporter) throws IOException {
            // Pull the key out
            String line = val.toString();
            int firstComma = line.indexOf(',');
            String key = line.substring(0, firstComma);
            String value = line.substring(firstComma + 1);
            Text outKey = new Text(key);
            // Prepend an index to the value so we know which file
            // it came from.
            Text outVal = new Text("1" + value);
            oc.collect(outKey, outVal);
        }
    }

    public static class LoadAndFilterUsers extends MapReduceBase
        implements Mapper<LongWritable, Text, Text, Text> {
        public void map(LongWritable k, Text val,
            OutputCollector<Text, Text> oc,
            Reporter reporter) throws IOException {
            // Pull the key out
            String line = val.toString();
            int firstComma = line.indexOf(',');
            String value = line.substring(firstComma + 1);
            int age = Integer.parseInt(value);
            if (age < 18 || age > 25) return;
            String key = line.substring(0, firstComma);
            Text outKey = new Text(key);
            // Prepend an index to the value so we know which file
            // it came from.
            Text outVal = new Text("2" + value);
            oc.collect(outKey, outVal);
        }
    }

    public static class Join extends MapReduceBase
        implements Reducer<Text, Text, Text, Text> {
        public void reduce(Text key,
            Iterator<Text> iter,
            OutputCollector<Text, Text> oc,
            Reporter reporter) throws IOException {
            // For each value, figure out which file it's from and
            // accordingly.
            List<String> first = new ArrayList<String>();
            List<String> second = new ArrayList<String>();

            while (iter.hasNext()) {
                Text t = iter.next();
                String value = t.toString();
                if (value.charAt(0) == '1')
                    first.add(value.substring(1));
                else second.add(value.substring(1));
            }

            reporter.setStatus("OK");
        }
    }

    // Do the cross product and collect the values
    for (String s1 : first) {
        for (String s2 : second) {
            String outVal = key + "," + s1 + "," + s2;
            oc.collect(null, new Text(outVal));
            reporter.setStatus("OK");
        }
    }
}

public static class LoadJoined extends MapReduceBase
    implements Mapper<Text, Text, Text, LongWritable> {
    public void map(
        Text k,
        Text val,
        OutputCollector<Text, LongWritable> oc,
        Reporter reporter) throws IOException {
        // Find the url
        String line = val.toString();
        int firstComma = line.indexOf(',');
        int secondComma = line.indexOf(',', firstComma);
        String key = line.substring(firstComma, secondComma);
        // drop the rest of the record, I don't need it anymore,
        // just pass a 1 for the combiner/reducer to sum instead.
        Text outKey = new Text(key);
        oc.collect(outKey, new LongWritable(1L));
    }
}

public static class ReduceUrls extends MapReduceBase
    implements Reducer<Text, LongWritable, WritableComparable,
        Writable> {
    public void reduce(
        Text key,
        Iterator<LongWritable> iter,
        OutputCollector<WritableComparable, Writable> oc,
        Reporter reporter) throws IOException {
        // Add up all the values we see
        long sum = 0;
        while (iter.hasNext()) {
            sum += iter.next().get();
            reporter.setStatus("OK");
        }
        oc.collect(key, new LongWritable(sum));
    }
}

public static class LoadClicks extends MapReduceBase
    implements Mapper<WritableComparable, Writable, LongWritable,
        Text> {
    public void map(
        WritableComparable key,
        Writable val,
        OutputCollector<LongWritable, Text> oc,
        Reporter reporter) throws IOException {
        oc.collect((LongWritable)val, (Text)key);
    }
}

public static class LimitClicks extends MapReduceBase
    implements Reducer<LongWritable, Text, LongWritable, Text> {
    int count = 0;
    public void reduce(
        LongWritable key,
        Iterator<Text> iter,
        OutputCollector<LongWritable, Text> oc,
        Reporter reporter) throws IOException {
        // Only output the first 100 records
        while (count < 100 && iter.hasNext()) {
            oc.collect(key, iter.next());
            count++;
        }
    }
}

public static void main(String[] args) throws IOException {
    JobConf lp = new JobConf(MRExample.class);
    lp.setJobName("Load Pages");
    lp.setInputFormat(TextInputFormat.class);
    lp.setOutputKeyClass(Text.class);
    lp.setOutputValueClass(LoadPages.class);
    FileInputFormat.addInputPath(lp, new
        Path("/user/gates/pages"));
    FileOutputFormat.setOutputPath(lp,
        new Path("/user/gates/tmp/indexed_pages"));
    lp.setNumReduceTasks(0);
    Job loadPages = new Job(lp);

    JobConf lfu = new JobConf(MRExample.class);
    lfu.setJobName("Load and Filter Users");
    lfu.setInputFormat(TextInputFormat.class);
    lfu.setOutputKeyClass(Text.class);
    lfu.setOutputValueClass(LoadAndFilterUsers.class);
    FileInputFormat.addInputPath(lfu, new
        Path("/user/gates/users"));
    FileOutputFormat.setOutputPath(lfu,
        new Path("/user/gates/tmp/filtered_users"));
    lfu.setNumReduceTasks(0);
    Job loadUsers = new Job(lfu);

    JobConf join = new JobConf(MRExample.class);
    join.setJobName("Join Users and Pages");
    join.setInputFormat(KeyValueTextInputFormat.class);
    join.setOutputKeyClass(Text.class);
    join.setOutputValueClass(Text.class);
    join.setMapperClass(IdentityMapper.class);
    join.setReducerClass(Join.class);
    FileInputFormat.addInputPath(join, new
        Path("/user/gates/tmp/filtered_users"));
    FileInputFormat.addInputPath(join, new
        Path("/user/gates/tmp/indexed_pages"));
    FileOutputFormat.setOutputPath(join, new
        Path("/user/gates/tmp/joined"));
    join.setNumReduceTasks(50);
    Job joinJob = new Job(join);
    joinJob.addDependingJob(loadPages);
    joinJob.addDependingJob(loadUsers);

    JobConf group = new JobConf(MRExample.class);
    group.setJobName("Group URLs");
    group.setInputFormat(KeyValueTextInputFormat.class);
    group.setOutputKeyClass(Text.class);
    group.setOutputValueClass(LongWritable.class);
    group.setOutputFormat(SequenceFileOutputFormat.class);
    group.setMapperClass(LoadJoined.class);
    group.setCombinerClass(ReduceUrls.class);
    group.setReducerClass(ReduceUrls.class);
    FileInputFormat.addInputPath(group, new
        Path("/user/gates/tmp/joined"));
    FileOutputFormat.setOutputPath(group, new
        Path("/user/gates/tmp/grouped"));
    group.setNumReduceTasks(50);
    Job groupJob = new Job(group);
    groupJob.addDependingJob(joinJob);

    JobConf top100 = new JobConf(MRExample.class);
    top100.setJobName("Top 100 sites");
    top100.setInputFormat(SequenceFileInputFormat.class);
    top100.setOutputKeyClass(LongWritable.class);
    top100.setOutputValueClass(Text.class);
    top100.setOutputFormat(SequenceFileOutputFormat.class);
    top100.setMapperClass(LoadClicks.class);
    top100.setCombinerClass(LimitClicks.class);
    top100.setReducerClass(LimitClicks.class);
    FileInputFormat.addInputPath(top100, new
        Path("/user/gates/tmp/grouped"));
    FileOutputFormat.setOutputPath(top100, new
        Path("/user/gates/top100sitesforusers18to25"));
    top100.setNumReduceTasks(1);
    Job limit = new Job(top100);
    limit.addDependingJob(groupJob);

    JobControl jc = new JobControl("Find top 100 sites for users
        18 to 25");
    jc.addJob(loadPages);
    jc.addJob(loadUsers);
    jc.addJob(joinJob);
    jc.addJob(groupJob);
    jc.addJob(limit);
    jc.run();
}
}
```

170 lines of code, 4 hours to write



In Pig Latin

```
Users = load 'users' as (name, age);
Fltrd = filter Users by
    age >= 18 and age <= 25;
Pages = load 'pages' as (user, url);
Jnd = join Fltrd by name, Pages by user;
Grpd = group Jnd by url;
Smmd = foreach Grpd generate group,
    COUNT(Jnd) as clicks;
Srted = order Smmd by clicks desc;
Top5 = limit Srted 5;
store Top5 into 'top5sites';
```

9 lines of code, 15 minutes to write



But can it fly?

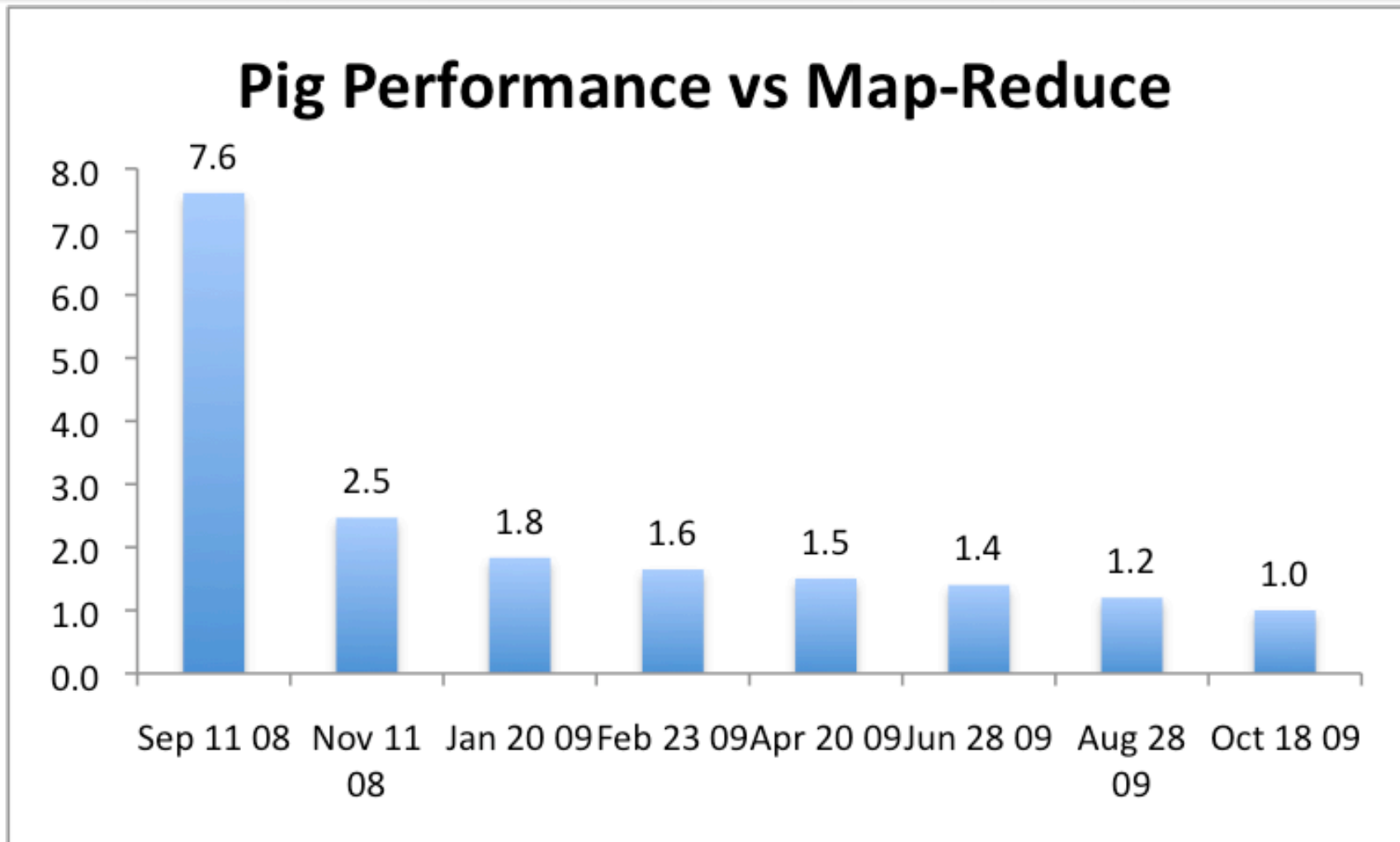

Essence of Pig

- Map-Reduce is too low a level to program, SQL too high
- Pig Latin, a language intended to sit between the two:
 - Imperative
 - Provides standard relational transforms (join, sort, etc.)
 - Schemas are optional, used when available, can be defined at runtime
 - User Defined Functions are first class citizens
 - Opportunities for advanced optimizer but optimizations by programmer also possible



How It Works



Script

```
A = load  
B = filter  
C = group  
D = foreach
```

Parser

Logical Plan \approx
relational algebra

Logical Plan

Semantic
Checks

Logical Plan

Plan standard
optimizations

Logical
Optimizer

Logical Plan

MapReduce
Launcher

Map-Reduce Plan

Physical
To MR
Translator

Physical Plan

Logical to
Physical
Translator

Jar to
hadoop



Map-Reduce Plan =
physical operators
broken into Map,
Combine, and
Reduce stages

Physical Plan =
physical operators
to be executed

Cool Things We've Added In the Last Year

- Multiquery – Ability to combine multiple group bys into a single MR job (0.3)
- Merge join – If data is already sorted on join key, do join via merge in map phase (0.4)
- Skew join – Hash join for data with skew in join key. Allows splitting of key across multiple reducers to handle skew. (0.4)
- Zebra – Contrib project that provides columnar storage of data (0.4)
- Rework of Load and Store functions to make them much easier to write (0.7, branched but not released)
- Owl, a metadata service for the grid (committed, will be released in 0.8).



Fragment Replicate Join

Aka
"Broakdcast Join"

Pages

Users

Fragment Replicate Join

Aka
"Broakdcast Join"

```
Users = load `users` as (name, age);  
Pages = load `pages` as (user, url);  
Jnd = join Pages by user, Users by name using "replicated";
```

Pages

Users

Fragment Replicate Join

Aka
"Broakdcast Join"

```
Users = load `users` as (name, age);  
Pages = load `pages` as (user, url);  
Jnd = join Pages by user, Users by name using "replicated";
```

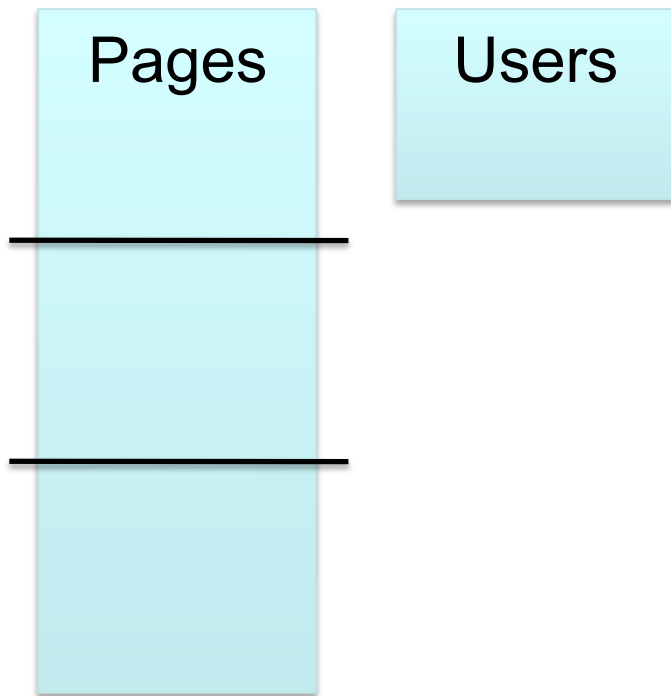

Fragment Replicate Join

Aka
"Broakdcast Join"

```
Users = load `users` as (name, age);  
Pages = load `pages` as (user, url);  
Jnd = join Pages by user, Users by name using "replicated";
```

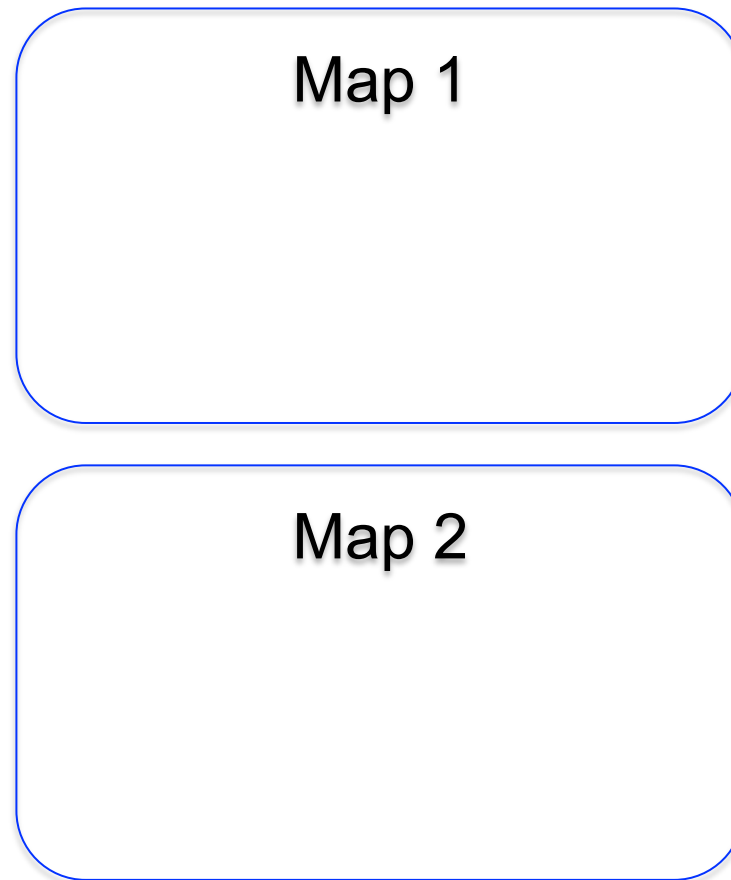
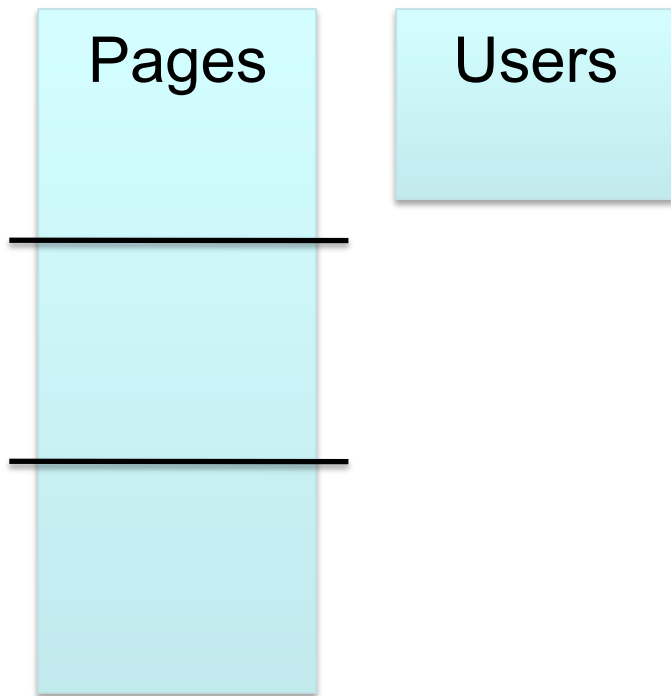

Fragment Replicate Join

Aka
"Broakdcast Join"

```
Users = load `users` as (name, age);  
Pages = load `pages` as (user, url);  
Jnd = join Pages by user, Users by name using "replicated";
```

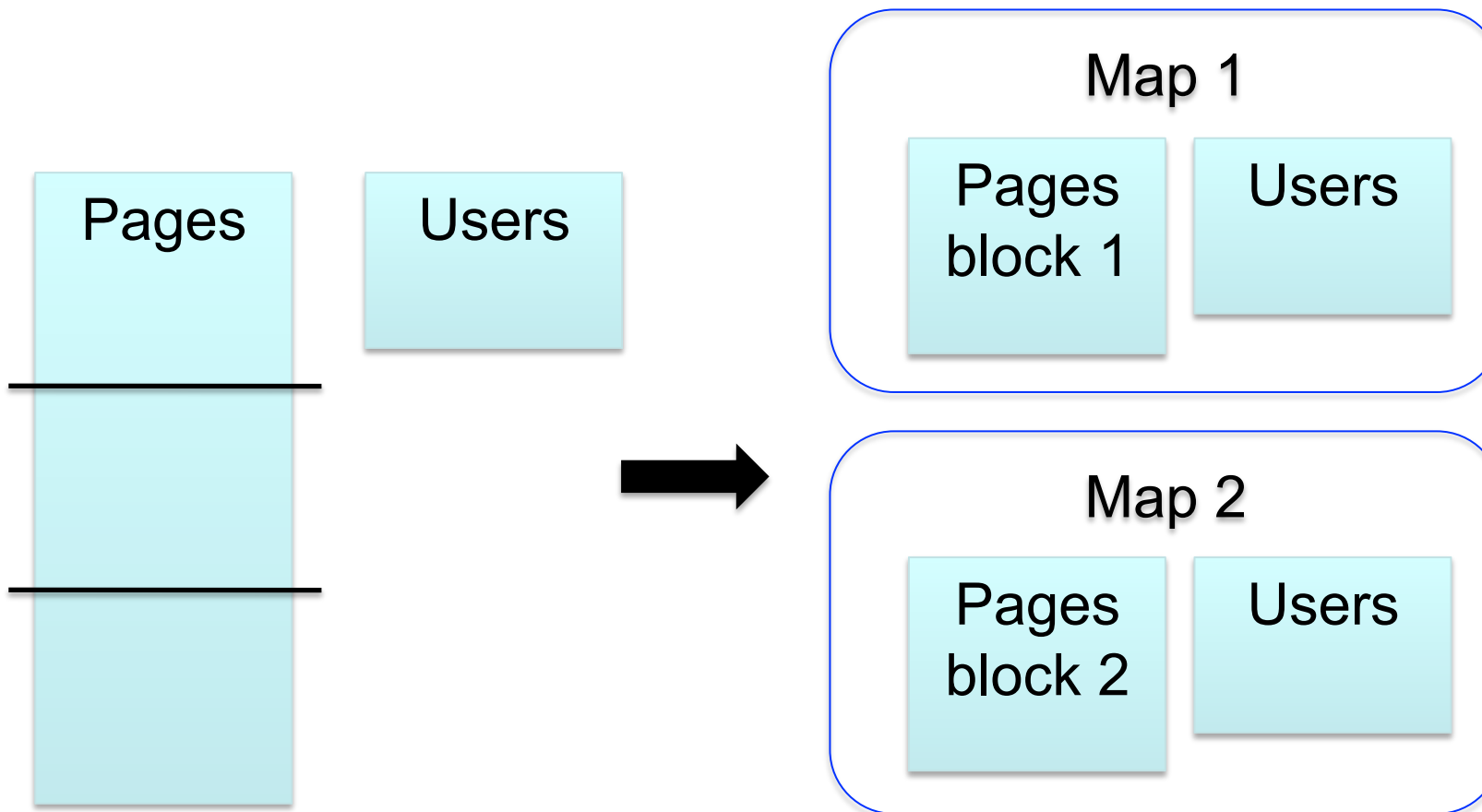

Hash Join

Pages

Users



Hash Join

```
Users = load `users` as (name, age);  
Pages = load `pages` as (user, url);  
Jnd = join Users by name, Pages by user;
```

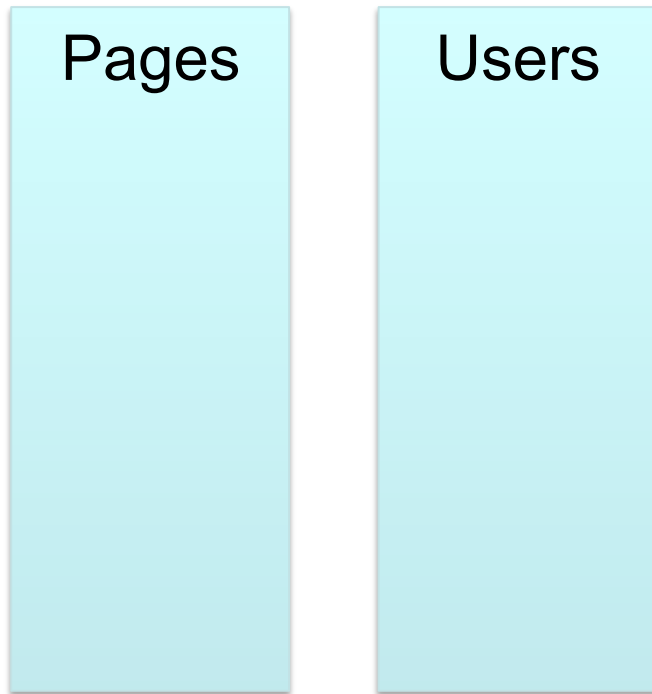

Hash Join

```
Users = load `users` as (name, age);  
Pages = load `pages` as (user, url);  
Jnd = join Users by name, Pages by user;
```

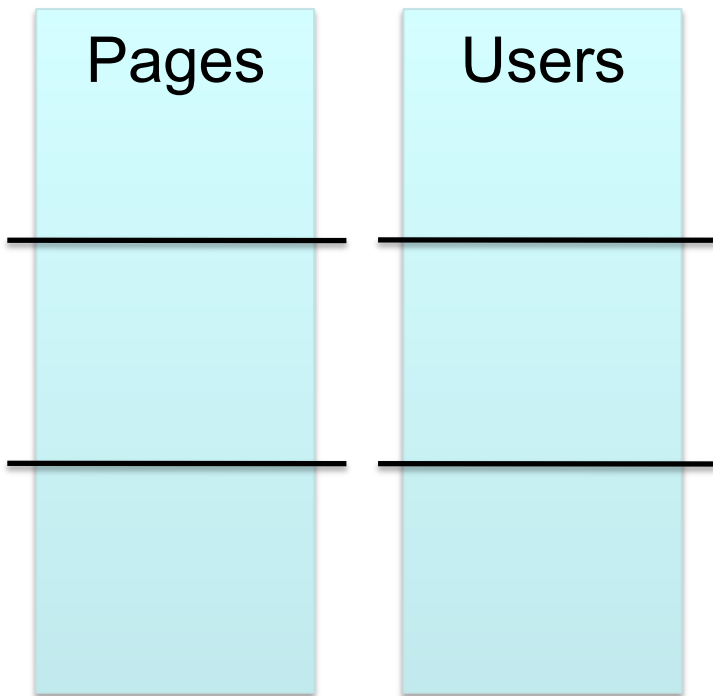

Hash Join

```
Users = load `users` as (name, age);  
Pages = load `pages` as (user, url);  
Jnd = join Users by name, Pages by user;
```

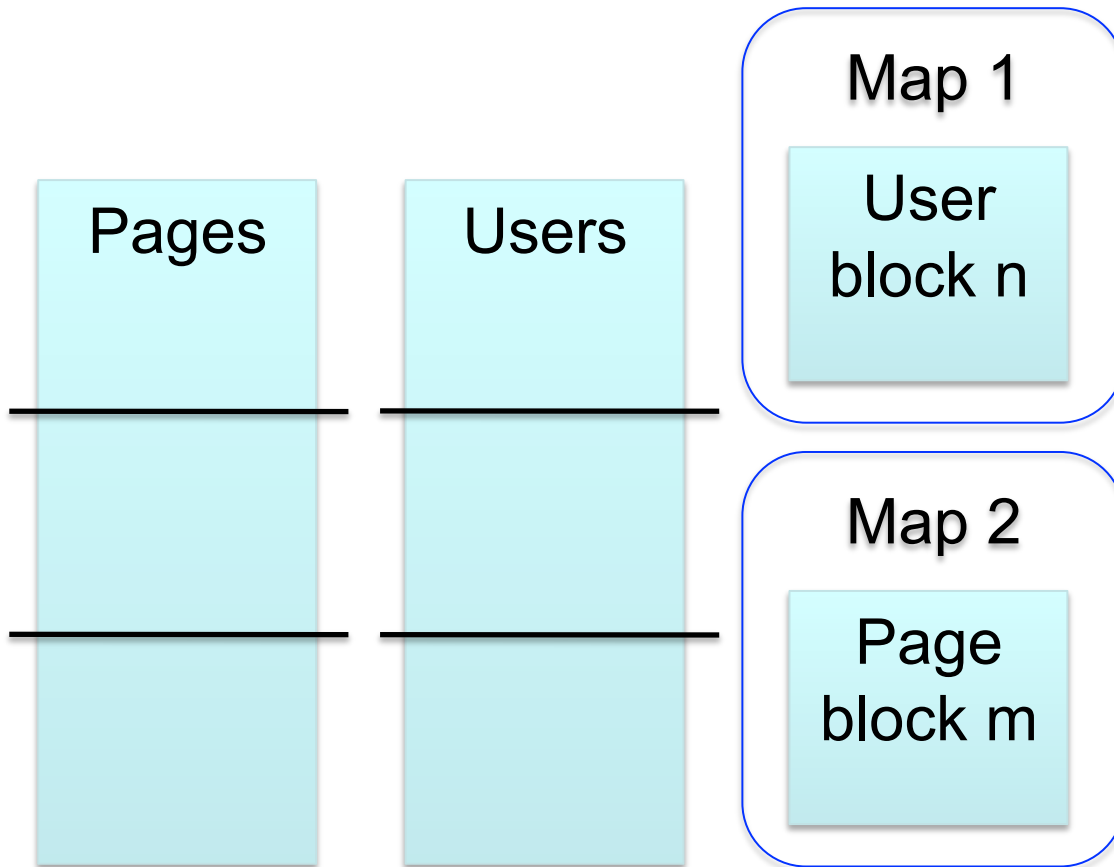

Hash Join

```
Users = load `users` as (name, age);  
Pages = load `pages` as (user, url);  
Jnd = join Users by name, Pages by user;
```

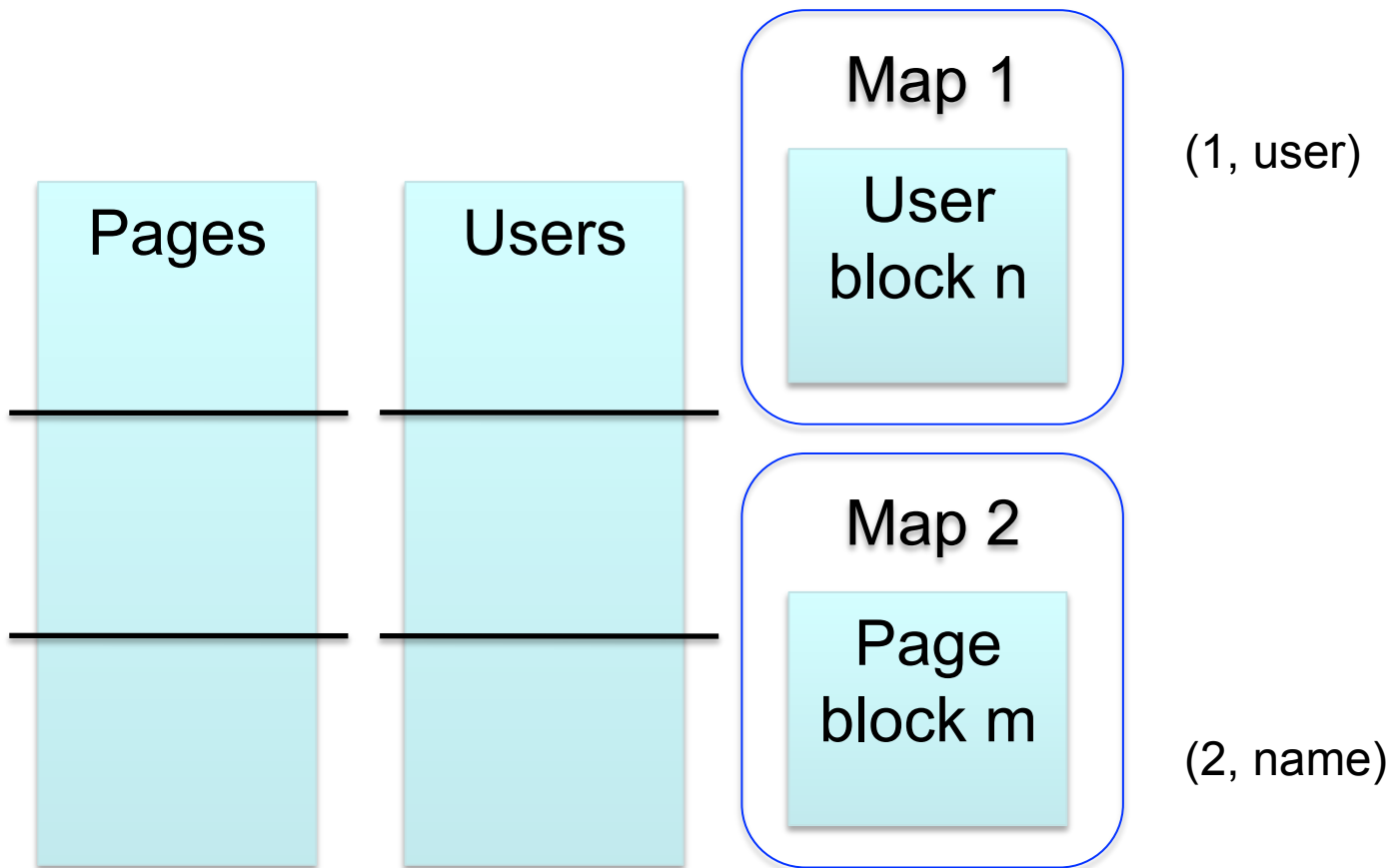

Hash Join

```
Users = load `users` as (name, age);  
Pages = load `pages` as (user, url);  
Jnd = join Users by name, Pages by user;
```

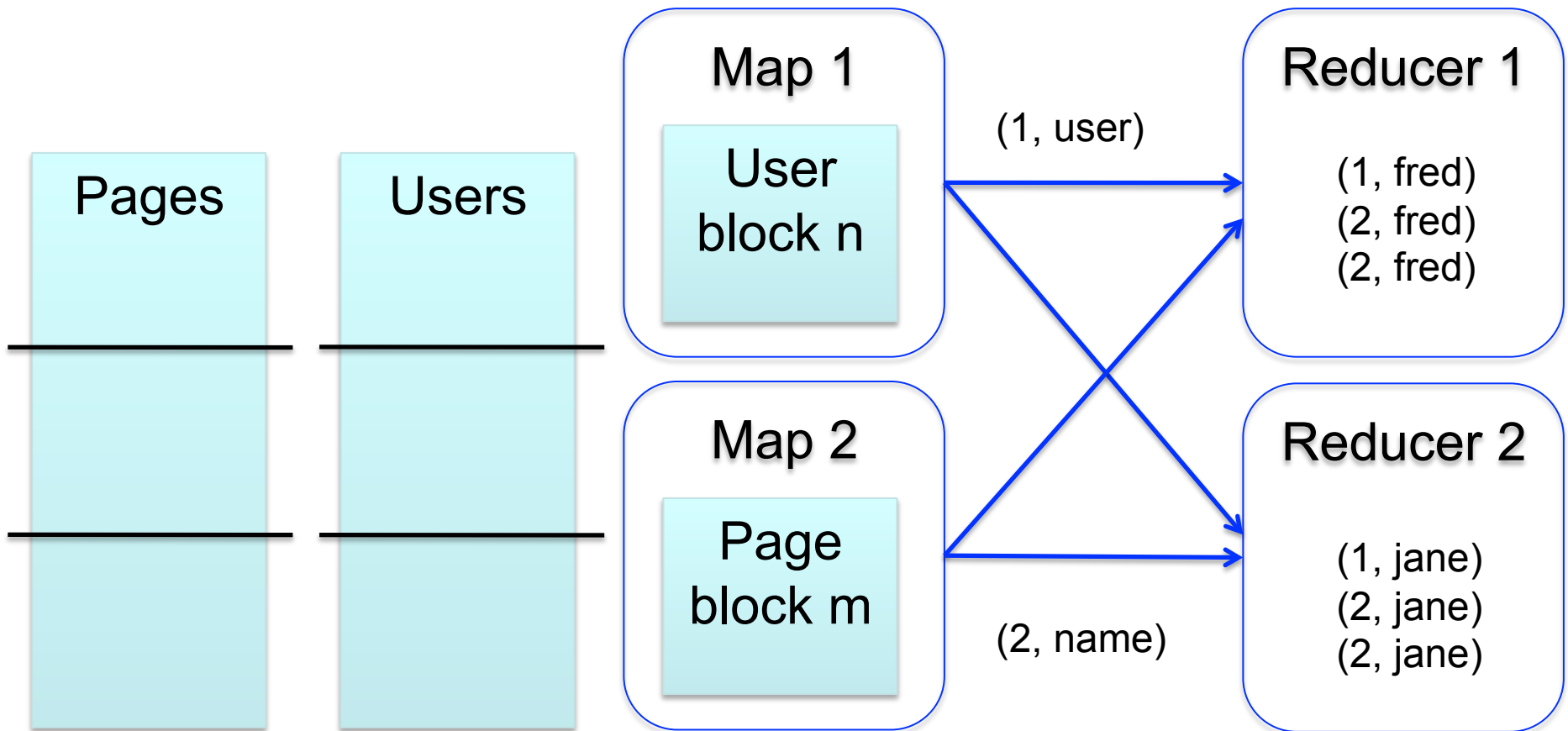

Skew Join

Pages

Users

Skew Join

```
Users = load `users` as (name, age);  
Pages = load `pages` as (user, url);  
Jnd = join Pages by user, Users by name using "skewed";
```

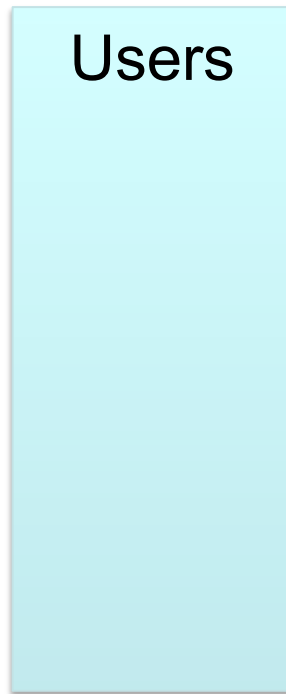

Skew Join

```
Users = load `users` as (name, age);  
Pages = load `pages` as (user, url);  
Jnd = join Pages by user, Users by name using "skewed";
```

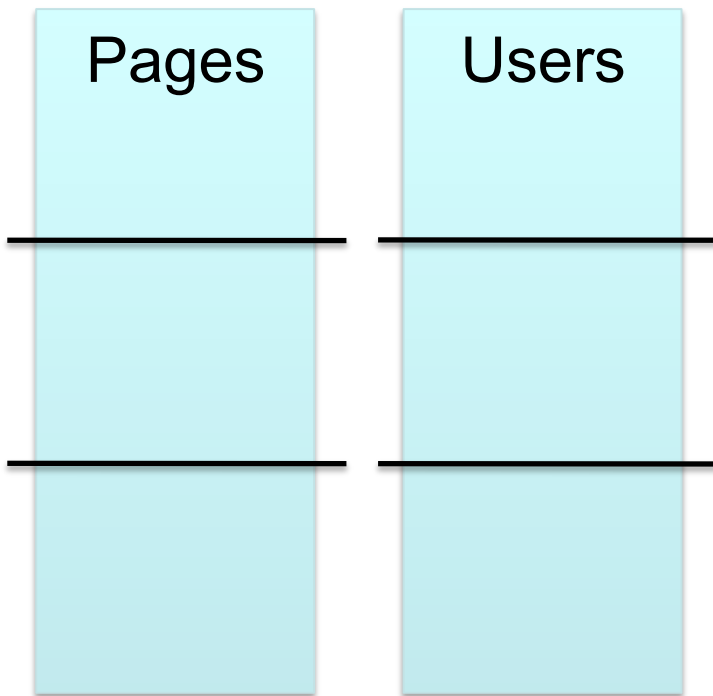

Skew Join

```
Users = load `users` as (name, age);  
Pages = load `pages` as (user, url);  
Jnd = join Pages by user, Users by name using "skewed";
```

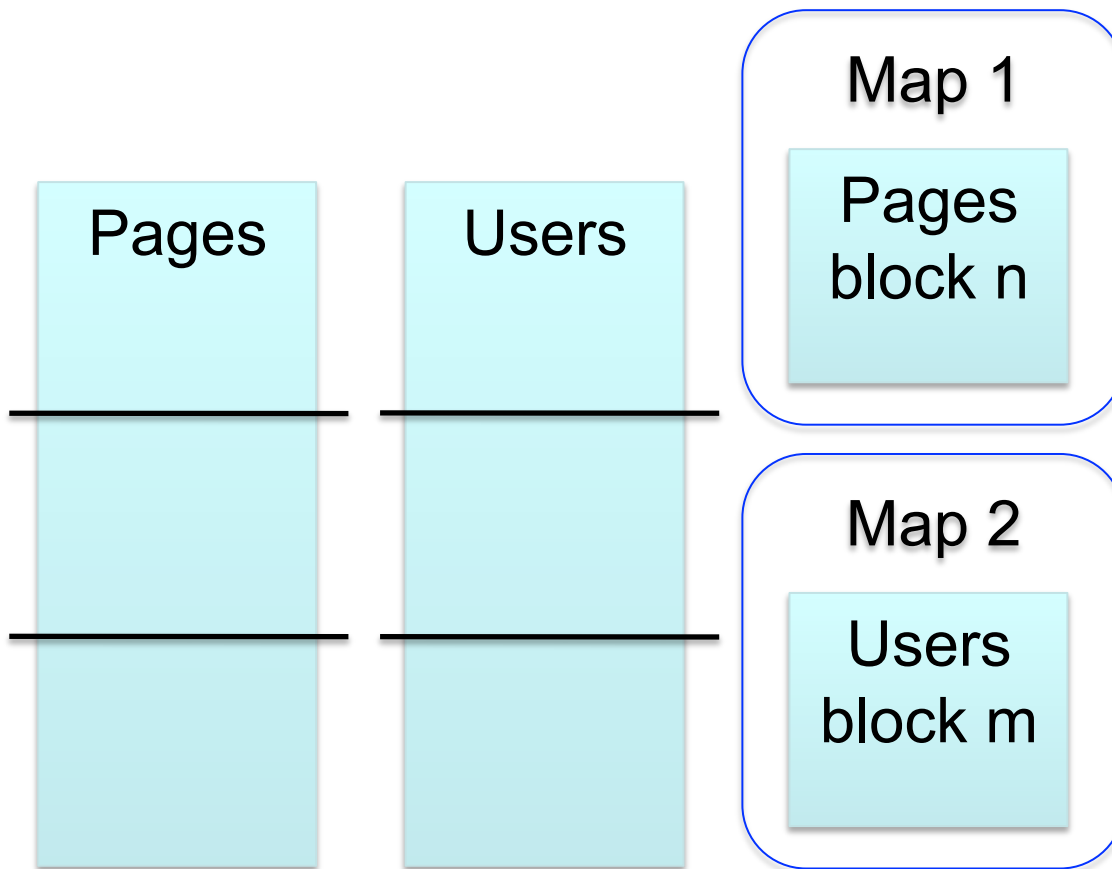

Skew Join

```
Users = load `users` as (name, age);  
Pages = load `pages` as (user, url);  
Jnd = join Pages by user, Users by name using "skewed";
```

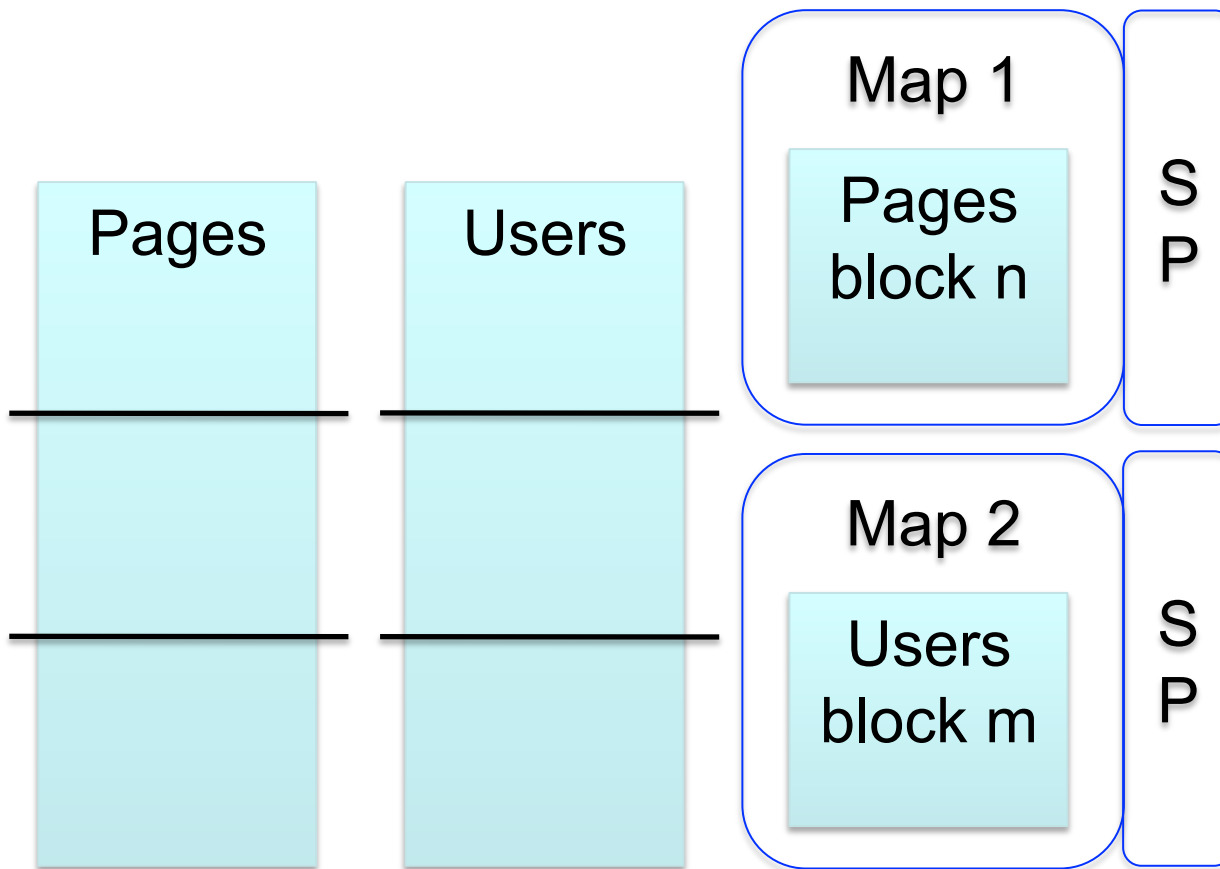

Skew Join

```
Users = load `users` as (name, age);  
Pages = load `pages` as (user, url);  
Jnd = join Pages by user, Users by name using "skewed";
```

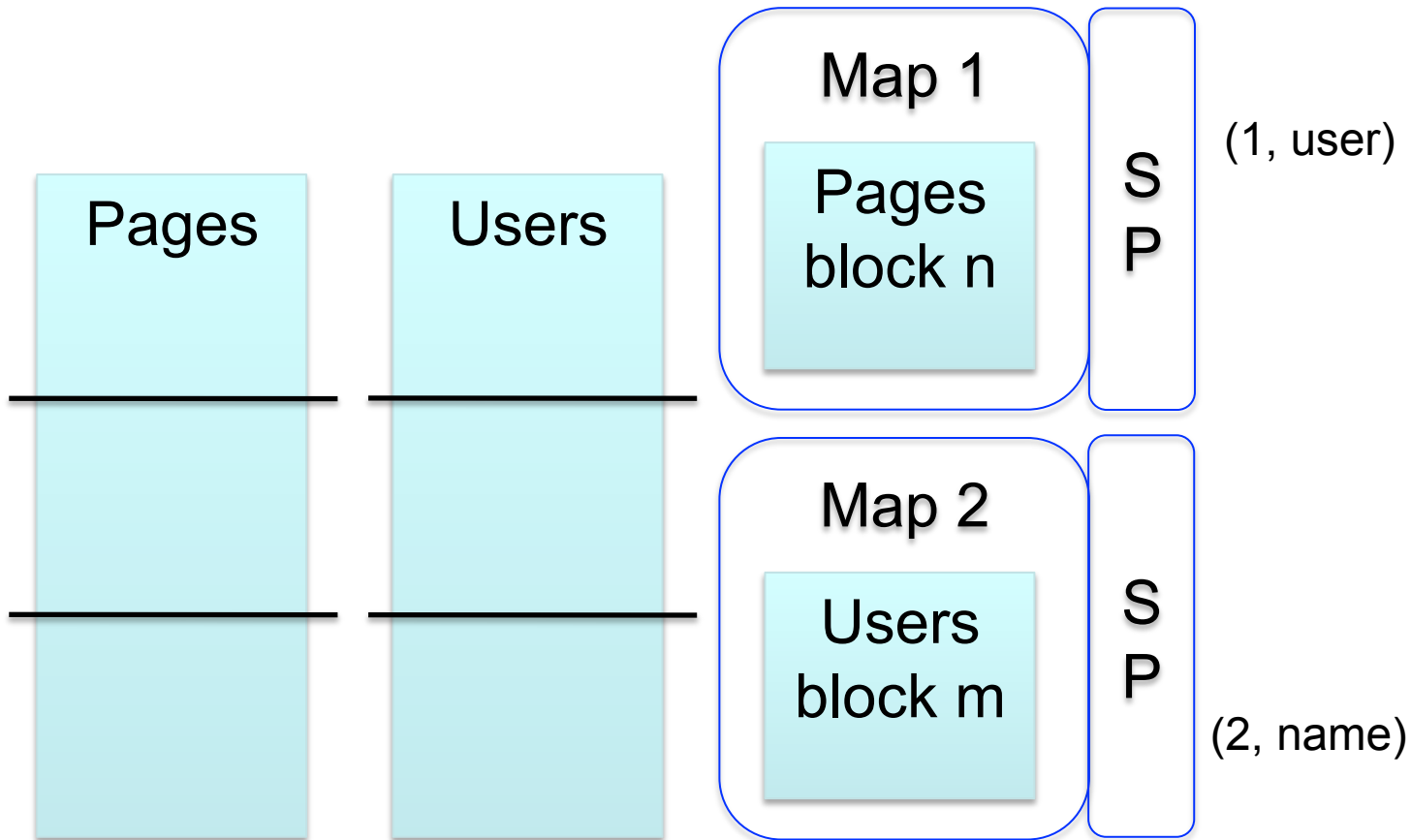

Skew Join

```
Users = load `users` as (name, age);  
Pages = load `pages` as (user, url);  
Jnd = join Pages by user, Users by name using "skewed";
```

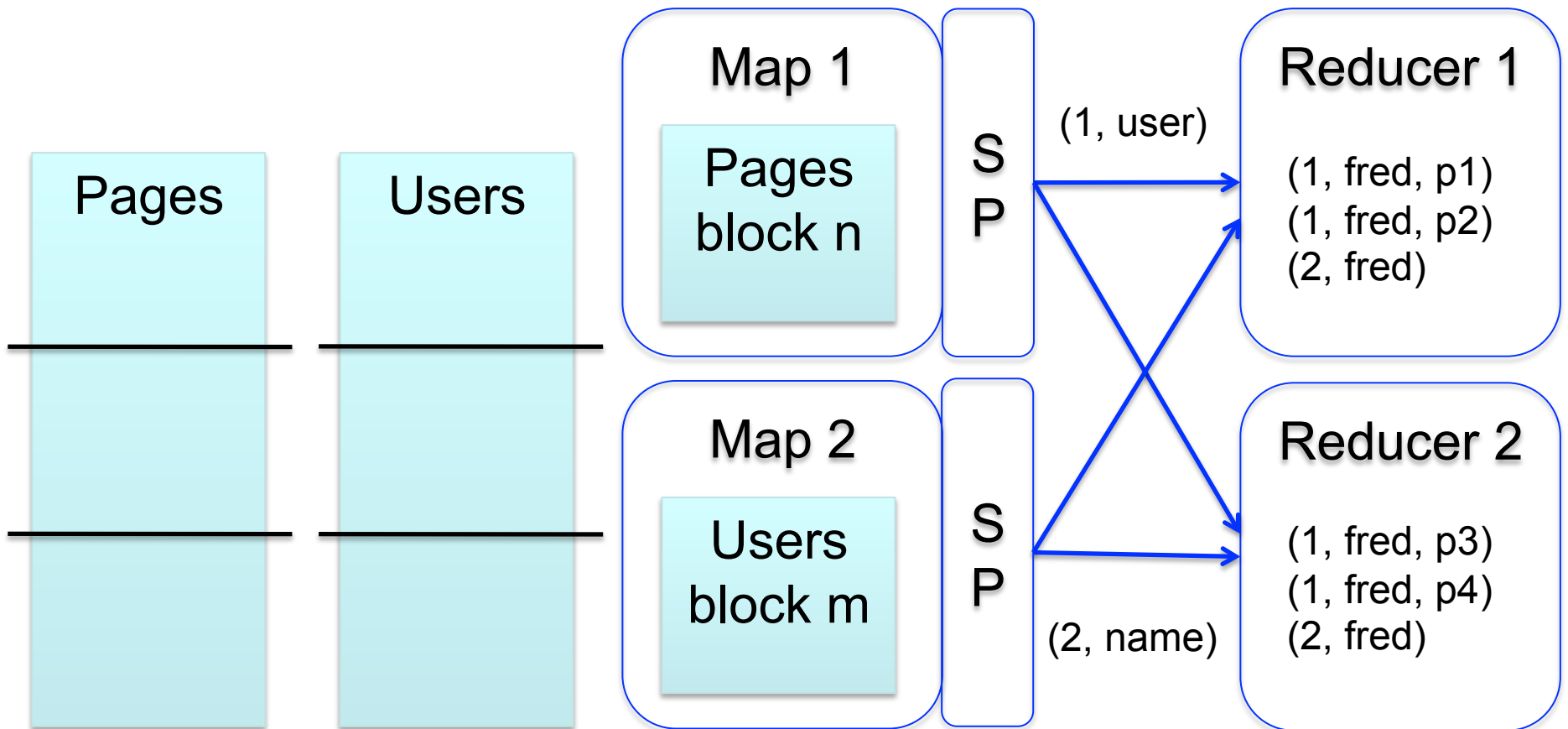

Merge Join

Pages
aaron
.
.
.
.
.
.
.
zach

Users
aaron
.
.
.
.
.
.
.
zach



Merge Join

```
Users = load `users` as (name, age);  
Pages = load `pages` as (user, url);  
Jnd = join Pages by user, Users by name using "merge";
```

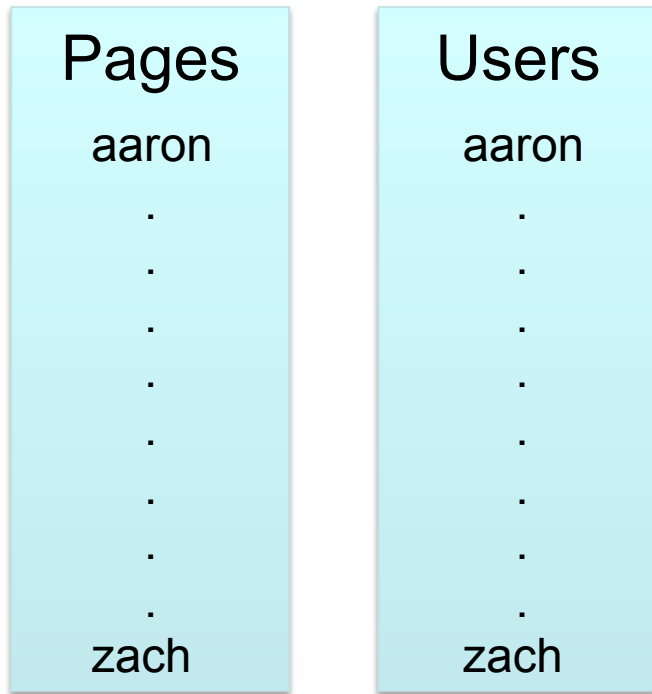

Merge Join

```
Users = load `users` as (name, age);  
Pages = load `pages` as (user, url);  
Jnd = join Pages by user, Users by name using "merge";
```

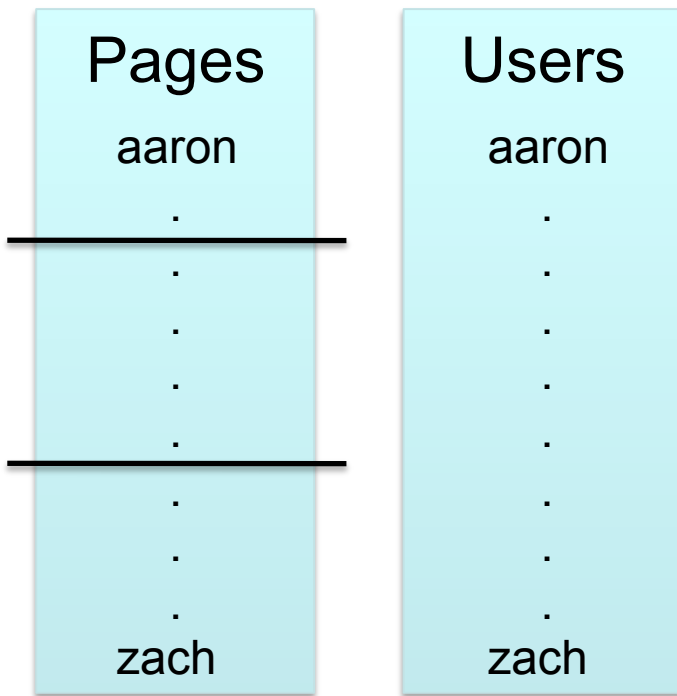

Multi-store script

```
A = load `users` as (name, age, gender,  
    city, state);  
B = filter A by name is not null;  
C1 = group B by age, gender;  
D1 = foreach C1 generate group, COUNT(B);  
store D into `bydemo`;  
C2 = group B by state;  
D2 = foreach C2 generate group, COUNT(B);  
store D2 into `bystate`;
```

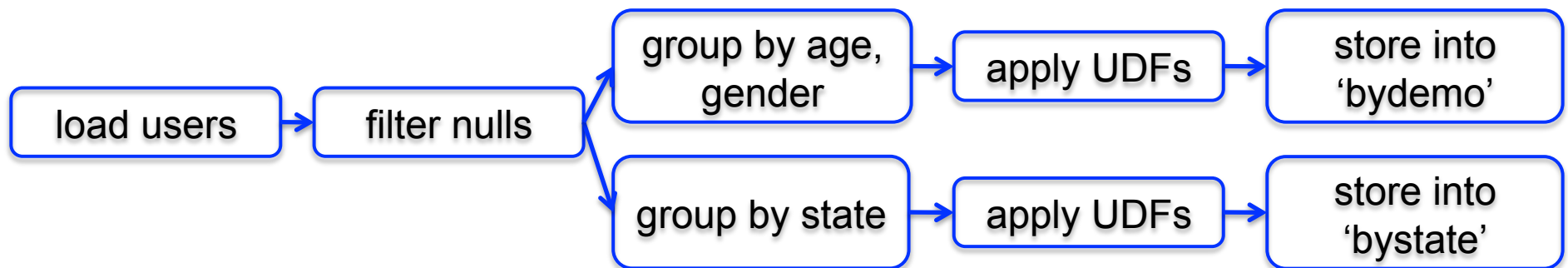

Multi-Store Map-Reduce Plan

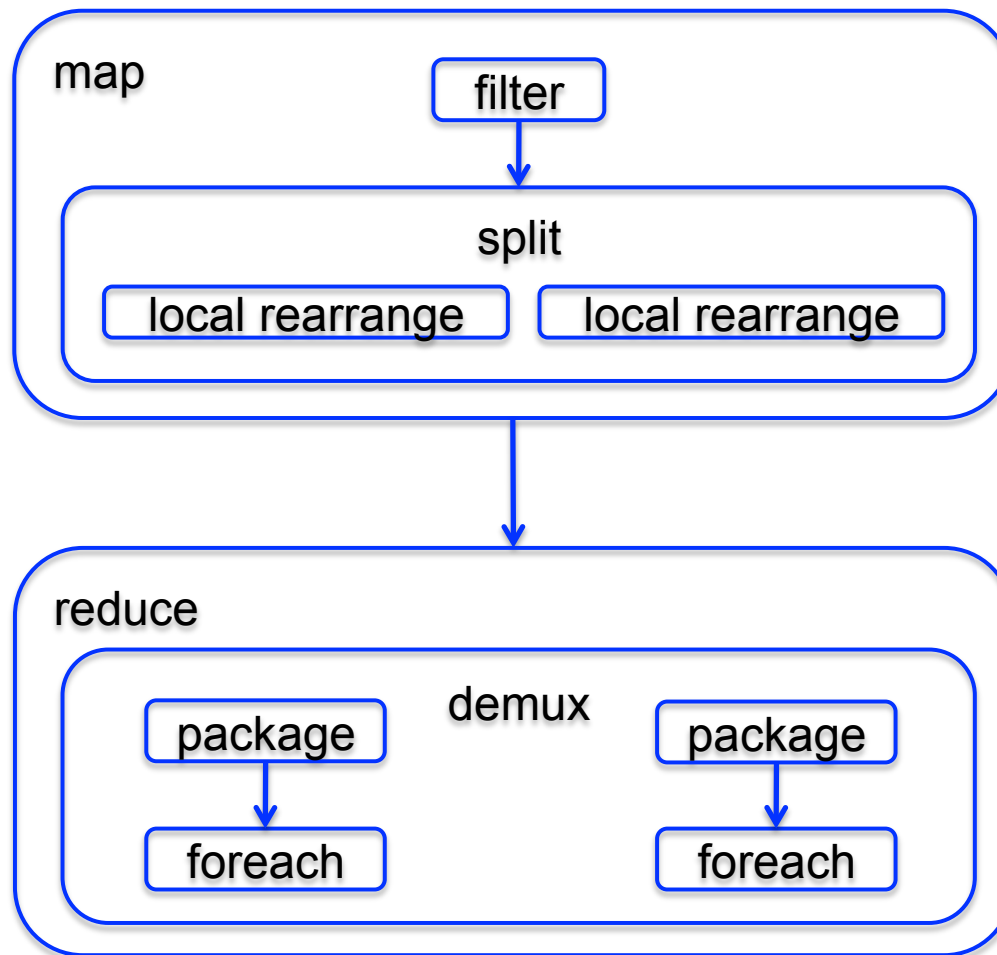

What are people doing with Pig

- At Yahoo ~70% of Hadoop jobs are Pig jobs
- Being used at Twitter, LinkedIn, and other companies
- Available as part of Amazon EMR web service and Cloudera Hadoop distribution
- What users use Pig for:
 - Search infrastructure
 - Ad relevance
 - Model training
 - User intent analysis
 - Web log processing
 - Image processing
 - Incremental processing of large data sets



What We're Working on this Year

- Optimizer rewrite
- Integrating Pig with metadata
- Usability – our current error messages might as well be written in actual Latin
- Automated usage info collection
- UDFs in python



Research Opportunities

- Cost based optimization – how does current RDBMS technology carry over to MR world?
- Memory Usage – given that data processing is very memory intensive and Java offers poor control of memory usage, how can Pig be written to use memory well?
- Automated Hadoop Tuning – Can Pig figure out how to configure Hadoop to best run a particular script?
- Indices, materialized views, etc. – How do these traditional RDBMS tools fit into the MR world?
- Human time queries – Analysts want access to the petabytes of data available via Hadoop, but they don't want to wait hours for their jobs to finish; can Pig find a way to answer analysts question in under 60 seconds?
- Map-Reduce-Reduce – Can MR be made more efficient for multiple MR jobs?
- How should Pig integrate with workflow systems?
- See more: <http://wiki.apache.org/pig/PigJournal>



Learn More

- Visit our website: <http://hadoop.apache.org/pig/>
- On line tutorials
 - From Yahoo, <http://developer.yahoo.com/hadoop/tutorial/>
 - From Cloudera, <http://www.cloudera.com/hadoop-training>
- A couple of Hadoop books are available that include chapters on Pig, search at your favorite bookstore
- Join the mailing lists:
 - pig-user@hadoop.apache.org for user questions
 - pig-dev@hadoop.apache.com for developer issues
- Contribute your work, over 50 people have so far

