

13. Particle Systems

1

Reading

Required:

- ♦ Witkin, *Particle System Dynamics*, SIGGRAPH '97 course notes on Physically Based Modeling.
- ♦ Witkin and Baraff, *Differential Equation Basics*, SIGGRAPH '01 course notes on Physically Based Modeling.

Optional

- ♦ Hockney and Eastwood. *Computer simulation using particles*. Adam Hilger, New York, 1988.
- ♦ Gavin Miller. "The motion dynamics of snakes and worms." *Computer Graphics* 22:169-178, 1988.

2

What are particle systems?

A **particle system** is a collection of point masses that obeys some physical laws (e.g. gravity, heat convection, spring behaviors, ...).

Particle systems can be used to simulate all sorts of physical phenomena:

3

Particle in a flow field

We begin with a single particle with:

- ♦ Position, $\mathbf{x} = \begin{bmatrix} x \\ y \end{bmatrix}$
- ♦ Velocity, $\mathbf{v} \equiv \dot{\mathbf{x}} = \frac{d\mathbf{x}}{dt} = \begin{bmatrix} dx/dt \\ dy/dt \end{bmatrix}$

Suppose the velocity is actually dictated by some driving function \mathbf{g} :

$$\dot{\mathbf{x}} = \mathbf{g}(\mathbf{x}, t)$$

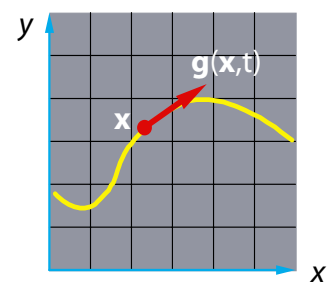

4

Vector fields

At any moment in time, the function \mathbf{g} defines a vector field over \mathbf{x} :

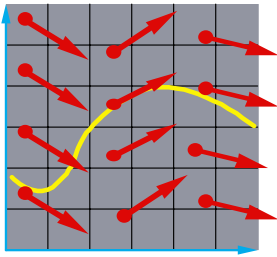

How does our particle move through the vector field?

5

Diff eqs and integral curves

The equation

$$\dot{\mathbf{x}} = \mathbf{g}(\mathbf{x}, t)$$

is actually a **first order differential equation**.

We can solve for \mathbf{x} through time by starting at an initial point and stepping along the vector field:

Start Here

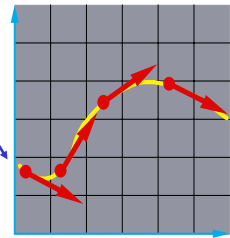

This is called an **initial value problem** and the solution is called an **integral curve**.

6

Euler's method

One simple approach is to choose a time step, Δt , and take linear steps along the flow:

$$\begin{aligned}\mathbf{x}(t + \Delta t) &= \mathbf{x}(t) + \Delta t \cdot \dot{\mathbf{x}}(t) \\ &= \mathbf{x}(t) + \Delta t \cdot \mathbf{g}(\mathbf{x}, t)\end{aligned}$$

Writing as a time iteration:

$$\mathbf{x}^{i+1} = \mathbf{x}^i + \Delta t \cdot \mathbf{v}^i$$

This approach is called **Euler's method** and looks like:

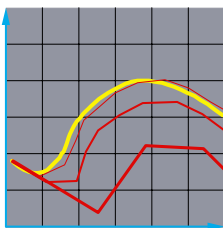

Properties:

- Simplest numerical method
- Bigger steps, bigger errors. Error $\sim O(\Delta t^2)$.

Need to take pretty small steps, so not very efficient. Better (more complicated) methods exist, e.g., "Runge-Kutta" and "implicit integration."

7

Particle in a force field

Now consider a particle in a force field \mathbf{f} .

In this case, the particle has:

- Mass, m
- Acceleration, $\mathbf{a} \equiv \ddot{\mathbf{x}} = \frac{d\mathbf{v}}{dt} = \frac{d^2\mathbf{x}}{dt^2}$

The particle obeys Newton's law:

$$\mathbf{f} = m\mathbf{a} = m\ddot{\mathbf{x}}$$

The force field \mathbf{f} can in general depend on the position and velocity of the particle as well as time.

Thus, with some rearrangement, we end up with:

$$\ddot{\mathbf{x}} = \frac{\mathbf{f}(\mathbf{x}, \dot{\mathbf{x}}, t)}{m}$$

8

Second order equations

This equation:

$$\ddot{\mathbf{x}} = \frac{\mathbf{f}(\mathbf{x}, \mathbf{v}, t)}{m}$$

is a **second order differential equation**.

Our solution method, though, worked on first order differential equations.

We can rewrite this as:

$$\begin{bmatrix} \dot{\mathbf{x}} = \mathbf{v} \\ \dot{\mathbf{v}} = \frac{\mathbf{f}(\mathbf{x}, \mathbf{v}, t)}{m} \end{bmatrix}$$

where we have added a new variable \mathbf{v} to get a pair of coupled first order equations.

9

Phase space

$$\begin{bmatrix} \mathbf{x} \\ \mathbf{v} \end{bmatrix}$$

Concatenate \mathbf{x} and \mathbf{v} to make a 6-vector: position in **phase space**.

$$\begin{bmatrix} \dot{\mathbf{x}} \\ \dot{\mathbf{v}} \end{bmatrix}$$

Taking the time derivative: another 6-vector.

$$\begin{bmatrix} \dot{\mathbf{x}} \\ \dot{\mathbf{v}} \end{bmatrix} = \begin{bmatrix} \mathbf{v} \\ \mathbf{f}/m \end{bmatrix}$$

A vanilla 1st-order differential equation.

10

Differential equation solver

Starting with:

$$\begin{bmatrix} \dot{\mathbf{x}} \\ \dot{\mathbf{v}} \end{bmatrix} = \begin{bmatrix} \mathbf{v} \\ \mathbf{f}/m \end{bmatrix}$$

Applying Euler's method:

$$\mathbf{x}(t + \Delta t) = \mathbf{x}(t) + \Delta t \cdot \dot{\mathbf{x}}(t)$$

$$\dot{\mathbf{x}}(t + \Delta t) = \dot{\mathbf{x}}(t) + \Delta t \cdot \dot{\dot{\mathbf{x}}}(t)$$

And making substitutions:

$$\mathbf{x}(t + \Delta t) = \mathbf{x}(t) + \Delta t \cdot \mathbf{v}(t)$$

$$\dot{\mathbf{x}}(t + \Delta t) = \dot{\mathbf{x}}(t) + \Delta t \cdot \frac{\mathbf{f}(\mathbf{x}, \dot{\mathbf{x}}, t)}{m}$$

Writing this as an iteration, we have:

$$\mathbf{x}^{i+1} = \mathbf{x}^i + \Delta t \cdot \mathbf{v}^i$$

$$\mathbf{v}^{i+1} = \mathbf{v}^i + \Delta t \cdot \frac{\mathbf{f}^i}{m}$$

Again, performs poorly for large Δt .

11

Particle structure

How do we represent a particle?

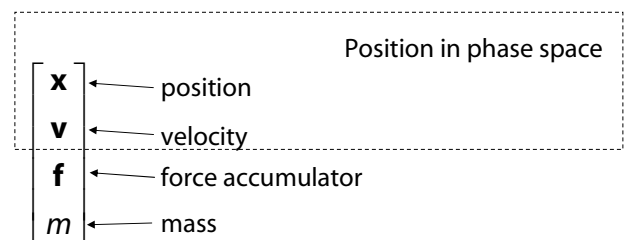

12

Single particle solver interface

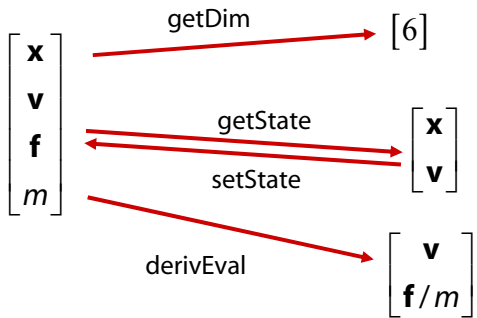

13

Particle systems

In general, we have a particle system consisting of n particles to be managed over time:

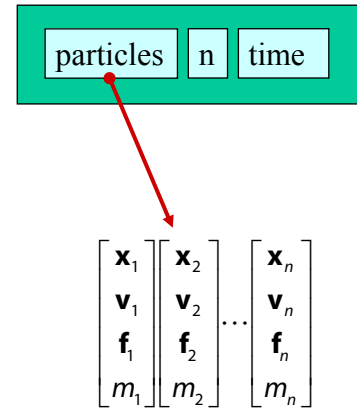

14

Particle system solver interface

For n particles, the solver interface now looks like:

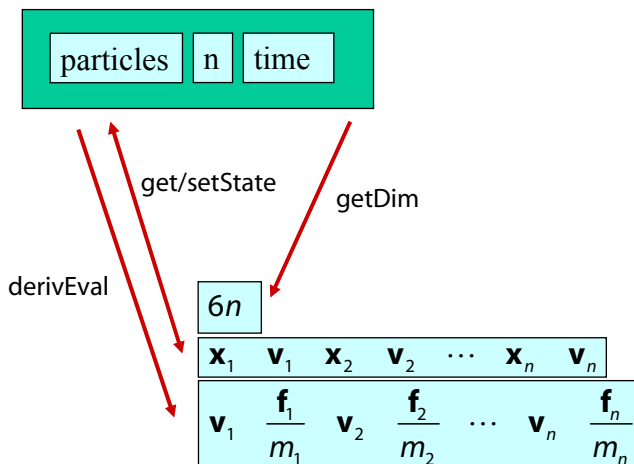

15

Particle system diff. eq. solver

We can solve the evolution of a particle system again using the Euler method:

$$\begin{bmatrix} \mathbf{x}_1^{i+1} \\ \mathbf{v}_1^{i+1} \\ \vdots \\ \mathbf{x}_n^{i+1} \\ \mathbf{v}_n^{i+1} \end{bmatrix} = \begin{bmatrix} \mathbf{x}_1^i \\ \mathbf{v}_1^i \\ \vdots \\ \mathbf{x}_n^i \\ \mathbf{v}_n^i \end{bmatrix} + \Delta t \begin{bmatrix} \mathbf{v}_1^i \\ \mathbf{f}_1^i / m_1 \\ \vdots \\ \mathbf{v}_n^i \\ \mathbf{f}_n^i / m_n \end{bmatrix}$$

16

Forces

Each particle can experience a force which sends it on its merry way.

Where do these forces come from? Some examples:

- Constant (gravity)
- Position/time dependent (force fields)
- Velocity-dependent (drag)
- N-ary (springs)

How do we compute the net force on a particle?

17

Particle systems with forces

Force objects are black boxes that point to the particles they influence and add in their contributions.

We can now visualize the particle system with force objects:

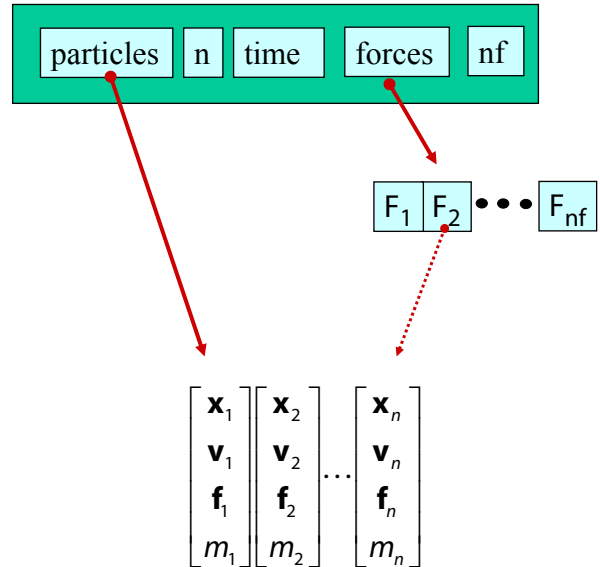

18

Gravity and viscous drag

The force due to **gravity** is simply:

$$\mathbf{f}_{grav} = m\mathbf{G}$$

$$\mathbf{p} \rightarrow \mathbf{f} += \mathbf{p} \rightarrow \mathbf{m} * \mathbf{F} \rightarrow \mathbf{G}$$

Often, we want to slow things down with **viscous drag**:

$$\mathbf{f}_{drag} = -k_{drag} \mathbf{v}$$

$$\mathbf{p} \rightarrow \mathbf{f} -= \mathbf{F} \rightarrow \mathbf{k} * \mathbf{p} \rightarrow \mathbf{v}$$

19

Damped spring

A spring is a simple examples of an "N-ary" force.

Recall the equation for the force due to a spring:

$$f = -k_{spring}(x - r)$$

We can augment this with damping:

$$f = -[k_{spring}(x - r) + k_{damp}v]$$

The resulting force equations become:

$$\mathbf{f}_1 = -\left[k_{spring}(|\Delta\mathbf{x}| - r) + k_{damp} \left(\frac{\Delta\mathbf{v} \cdot \Delta\mathbf{x}}{|\Delta\mathbf{x}|} \right) \right] \frac{\Delta\mathbf{x}}{|\Delta\mathbf{x}|}$$

$$\mathbf{f}_2 = -\mathbf{f}_1$$

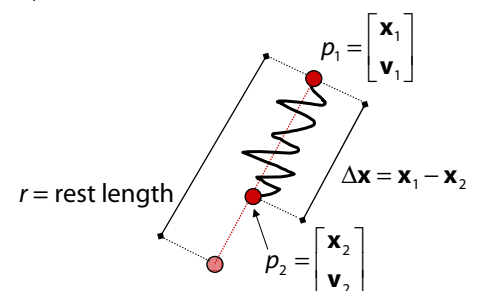

20

derivEval

1. Clear forces
 - Loop over particles, zero force accumulators
2. Calculate forces
 - Sum all forces into accumulators
3. Return derivatives
 - Loop over particles, return \mathbf{v} and \mathbf{f}/m

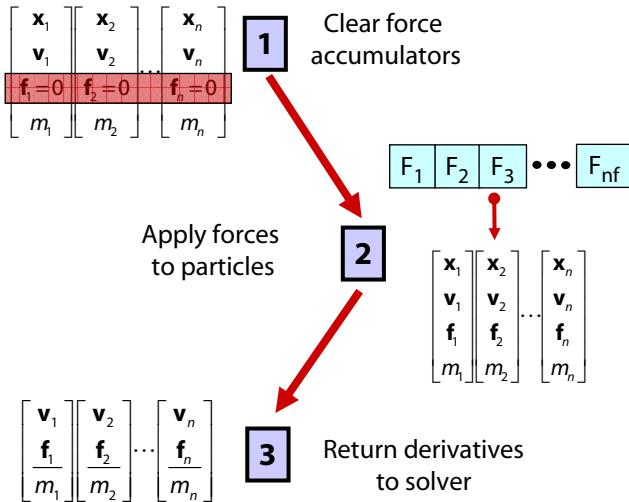

21

Bouncing off the walls

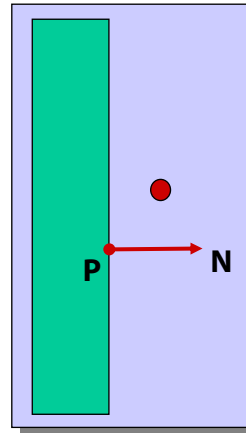

- Add-on for a particle simulator
- For now, just simple point-plane collisions

A plane is fully specified by any point \mathbf{P} on the plane and its normal \mathbf{N} .

22

Collision Detection

How do you decide when you've crossed a plane?

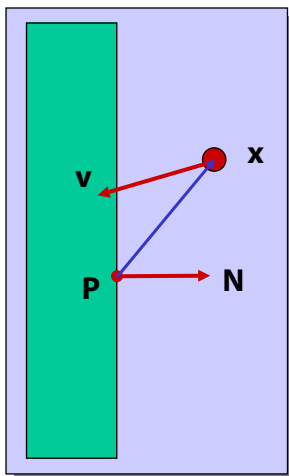

Normal and tangential velocity

To compute the collision response, we need to consider the normal and tangential components of a particle's velocity.

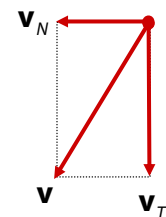
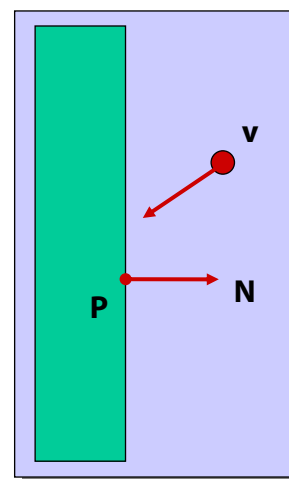

$$\mathbf{v}_N = (\mathbf{N} \cdot \mathbf{v})\mathbf{N}$$

$$\mathbf{v}_T = \mathbf{v} - \mathbf{v}_N$$

23

24

Collision Response

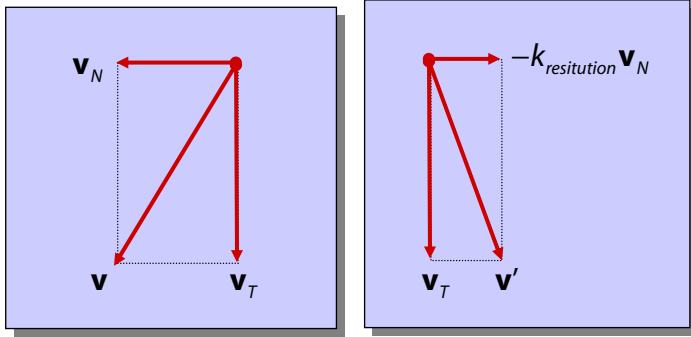

before

after

$$\mathbf{v}' = \mathbf{v}_T - k_{\text{restitution}} \mathbf{v}_N$$

Without backtracking, the response may not be enough to bring a particle to the other side of a wall. In that case, detection should include a velocity check:

25

Particle frame of reference

Let's say we had our robot arm example and we wanted to launch particles from its tip.



How would we go about starting the particles from the right place?

First, we have to look at the coordinate systems in the OpenGL pipeline...

26

The OpenGL geometry pipeline

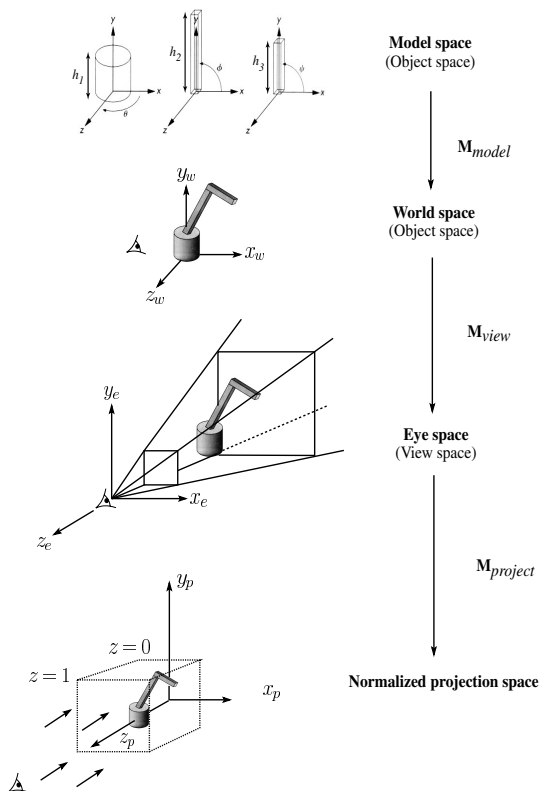

27

Projection and modelview matrices

Any piece of geometry will get transformed by a sequence of matrices before drawing:

$$\mathbf{p}' = \mathbf{M}_{\text{project}} \mathbf{M}_{\text{view}} \mathbf{M}_{\text{model}} \mathbf{p}$$

The first matrix is OpenGL's GL_PROJECTION matrix.

The second two matrices, taken as a product, are maintained on OpenGL's GL_MODELVIEW stack:

$$\mathbf{M}_{\text{modelview}} = \mathbf{M}_{\text{view}} \mathbf{M}_{\text{model}}$$

28

Robot arm code, revisited

Recall that the code for the robot arm looked something like:

```
glRotatef( theta, 0.0, 1.0, 0.0 );
base(h1);
glTranslatef( 0.0, h1, 0.0 );
glRotatef( phi, 0.0, 0.0, 1.0 );
upper_arm(h2);
glTranslatef( 0.0, h2, 0.0 );
glRotatef( psi, 0.0, 0.0, 1.0 );
lower_arm(h3);
```

All of the GL calls here modify the modelview matrix.

Note that even before these calls are made, the modelview matrix has been modified by the viewing transformation, \mathbf{M}_{view} .

Computing the particle launch point

To find the world coordinate position of the end of the robot arm, you need to follow a series of steps:

1. Figure out what \mathbf{M}_{view} before drawing your model.

```
Mat4f matCam = ps->glGetMatrix(GL_MODELVIEW_MATRIX);
```

2. Draw your model and add one more transformation to the tip of the robot arm.

```
glTranslatef( 0.0, h3, 0.0 );
```

3. Compute $\mathbf{M}_{\text{model}} = \mathbf{M}_{\text{view}}^{-1} \mathbf{M}_{\text{modelview}}$

```
Mat4f particleXform = ps->getWorldXform( matCam);
```

4. Transform a point at the origin by the resulting matrix.

```
Vec3f particleOrigin = particleXform * Vec3f(0,0,0);
```

Now you're ready to launch a particle from that last computed point!