

8. Distribution Ray Tracing

1

Reading

Required:

- ♦ Watt, sections 10.6, 14.8.

Further reading:

- ♦ A. Glassner. *An Introduction to Ray Tracing*. Academic Press, 1989. [In the lab.]
- ♦ Robert L. Cook, Thomas Porter, Loren Carpenter. "Distributed Ray Tracing." *Computer Graphics (Proceedings of SIGGRAPH 84)*. 18 (3). pp. 137-145. 1984.
- ♦ James T. Kajiya. "The Rendering Equation." *Computer Graphics (Proceedings of SIGGRAPH 86)*. 20 (4). pp. 143-150. 1986.

2

Pixel anti-aliasing

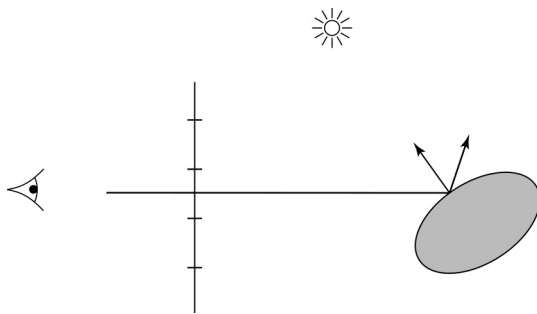

No anti-aliasing

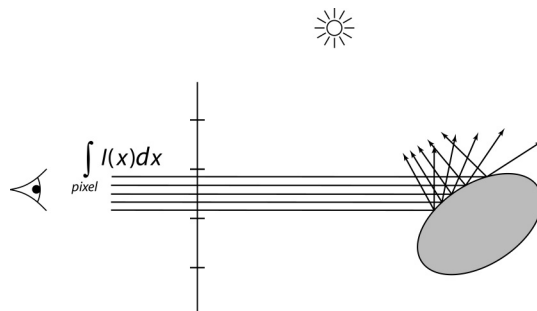

Pixel anti-aliasing

3

Surface reflection equation

In reality, surfaces do not reflect in a mirror-like fashion.

To compute the reflection from a real surface, we would actually need to solve the **surface reflection equation**:

$$I(\omega_{out}) = \int_H I(\omega_{in}) f_r(\omega_{in}, \omega_{out}) d\omega_{in}$$

How might we represent light from a single direction?

We can plot the reflected light as a function of viewing angle for multiple light source contributions:

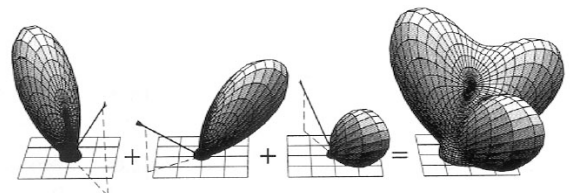

4

Simulating gloss and translucency

The mirror-like form of reflection, when used to approximate glossy surfaces, introduces a kind of aliasing, because we are undersampling reflection (and refraction).

For example:

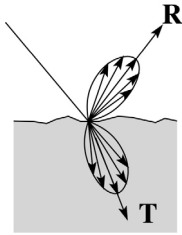

Distributing rays over reflection directions gives:

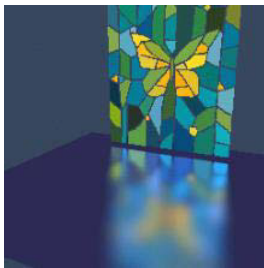

5

Reflection anti-aliasing

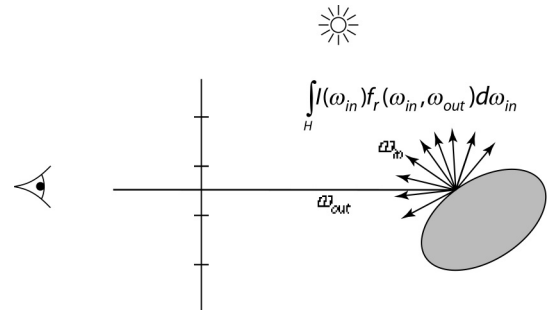

Reflection anti-aliasing

6

Full anti-aliasing

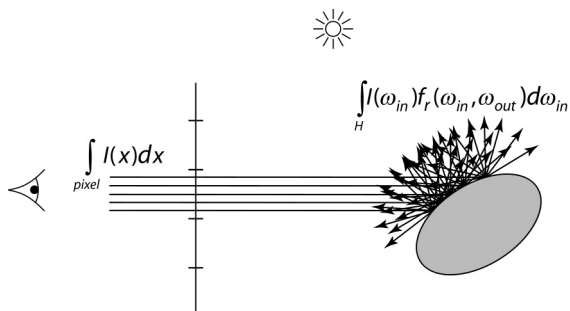

Full anti-aliasing...lots of nested integrals!

Computing these integrals is prohibitively expensive.

We'll look at ways to approximate integrals...

7

Approximating integrals

Let's say we want to compute the integral of a function:

$$F = \int f(x) dx$$

If $f(x)$ is not known analytically, but can be evaluated, then we can approximate the integral by:

$$F \approx \frac{1}{n} \sum f(i\Delta x)$$

Evaluating an integral in this manner is called **quadrature**.

8

Integrals as expected values

An alternative to distributing the sample positions regularly is to distribute them **stochastically**.

Let's say the position in x is a random variable X , which is distributed according to $p(x)$, a probability density function (strictly positive that integrates to unity).

Now let's consider a function of that random variable, $f(X)/p(X)$. What is the expected value of this new random variable?

First, recall the expected value of a function $g(X)$:

$$E[g(X)] = \int g(x)p(x)dx$$

Then, the expected value of $f(X)/p(X)$ is:

9

Monte Carlo integration

Thus, given a set of samples positions, X_i , we can estimate the integral as:

$$F \approx \frac{1}{n} \sum \frac{f(X_i)}{p(X_i)}$$

This procedure is known as **Monte Carlo integration**.

The trick is getting as accurate as possible with as few samples as possible.

More concretely, we would like the variance of the estimate of the integral to be low:

$$V\left[\frac{f(X)}{p(X)}\right] = E\left[\left(\frac{f(X)}{p(X)}\right)^2\right] - E\left[\frac{f(X)}{p(X)}\right]^2$$

The name of the game is **variance reduction**...

10

Uniform sampling

One approach is uniform sampling (i.e., choosing X from a uniform distribution):

11

Importance sampling

A better approach, if $f(x)$ is positive, would be to choose $p(x) \sim f(x)$. In fact, this choice would be optimal.

Why don't we just do that?

Alternatively, we can use heuristics to guess where $f(x)$ will be large. This approach is called **importance sampling**.

12

Summing over ray paths

We can think of this problem in terms of enumerated rays:

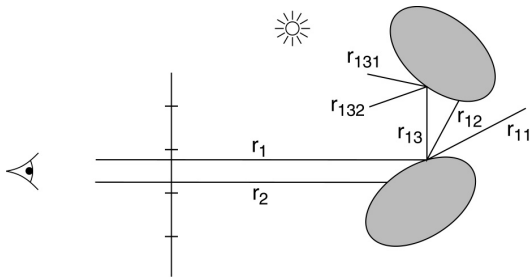

The intensity at a pixel is the sum over the primary rays:

$$I_{pixel} = \frac{1}{n} \sum_i^n I(r_i)$$

For a given primary ray, its intensity depends on secondary rays:

$$I(r_i) = \sum_j I(r_{ij}) f_r(r_{ij} \rightarrow r_i)$$

Substituting back in:

$$I_{pixel} = \sum_i \sum_j I(r_{ij}) f_r(r_{ij} \rightarrow r_i)$$

13

Summing over ray paths

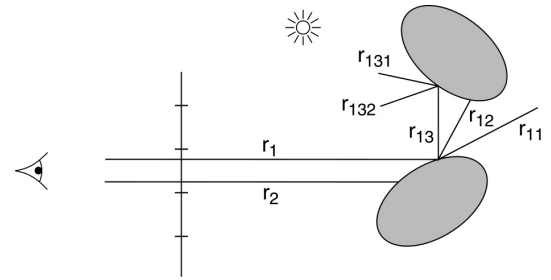

We can incorporate tertiary rays next:

$$I_{pixel} = \sum_i \sum_j \sum_k I(r_{ijk}) f_r(r_{ijk} \rightarrow r_{ij}) f_r(r_{ij} \rightarrow r_i)$$

Each triple i,j,k corresponds to a ray path:

$$r_{ijk} \rightarrow r_{ij} \rightarrow r_i$$

So, we can see that ray tracing is a way to approximate a complex, nested light transport integral with a summation over ray paths (of arbitrary length!).

Problem: too expensive to sum over all paths.

Solution: choose a small number of "good" paths.

14

Whitted integration

An anti-aliased Whitted ray tracer chooses very specific paths, i.e., paths starting on a regular sub-pixel grid with only perfect reflections (and refractions) that terminate at the light source.

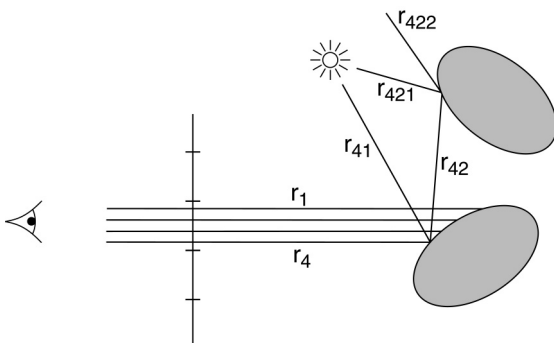

One problem with this approach is that it doesn't account for non-mirror reflection at surfaces.

15

Monte Carlo path tracing

Instead, we could choose paths starting from random sub-pixel locations with completely random decisions about reflection (and refraction). This approach is called **Monte Carlo path tracing** [Kajiya86].

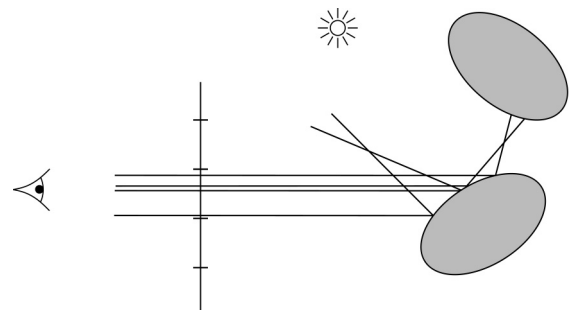

The advantage of this approach is that the answer is known to be unbiased and will converge to the right answer.

16

Importance sampling

The disadvantage of the completely random generation of rays is the fact that it samples unimportant paths and neglects important ones.

This means that you need a lot of rays to converge to a good answer.

The solution is to re-inject Whitted-like ideas: spawn rays to the light, and spawn rays that **favor** the specular direction.

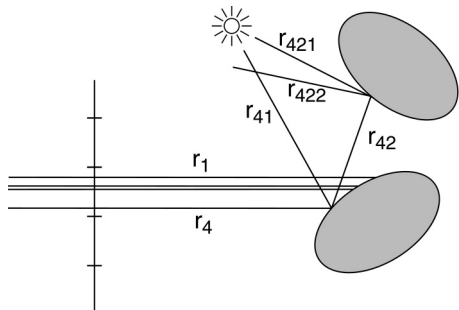

17

Stratified sampling

Another method that gives faster convergence is **stratified sampling**.

E.g., for sub-pixel samples:

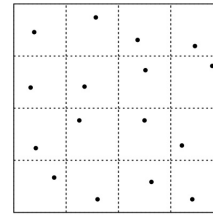

We call this a **jittered** sampling pattern.

One interesting side effect of these stochastic sampling patterns is that they actually injects noise into the solution (slightly grainier images). This noise tends to be less objectionable than aliasing artifacts.

18

Distribution ray tracing

These ideas can be combined to give a particular method called **distribution ray tracing** [Cook84]:

- ◆ uses non-uniform (jittered) samples.
- ◆ replaces aliasing artifacts with noise.
- ◆ provides additional effects by distributing rays to sample:
 - Reflections and refractions
 - Light source area
 - Camera lens area
 - Time

[Originally called "distributed ray tracing," but we will call it distribution ray tracing so as not to confuse with parallel computing.]

19

DRT pseudocode

TraceImage() looks basically the same, except now each pixel records the average color of jittered sub-pixel rays.

```
function traceImage (scene):  
  for each pixel (i, j) in image do  
    I(i, j) ← 0  
    for each sub-pixel id in (i, j) do  
      s ← pixelToWorld(jitter(i, j, id))  
      p ← COP  
      d ← (s - p).normalize()  
      I(i, j) ← I(i, j) + traceRay(scene, p, d, id)  
    end for  
    I(i, j) ← I(i, j)/numSubPixels  
  end for  
end function
```

A typical choice is numSubPixels = 4*4.

20

DRT pseudocode (cont'd)

Now consider *traceRay()*, modified to handle (only) opaque glossy surfaces:

```

function traceRay(scene, p, d, id):
  (q, N, material) ← intersect(scene, p, d)
  I ← shade(...)
  R ← jitteredReflectDirection(N, -d, id)
  I ← I + material. $k_r$  * traceRay(scene, q, R, id)
  return I
end function
  
```

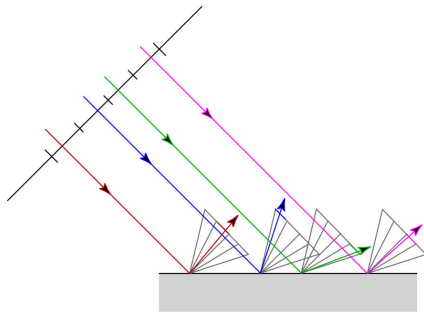

21

Pre-sampling glossy reflections

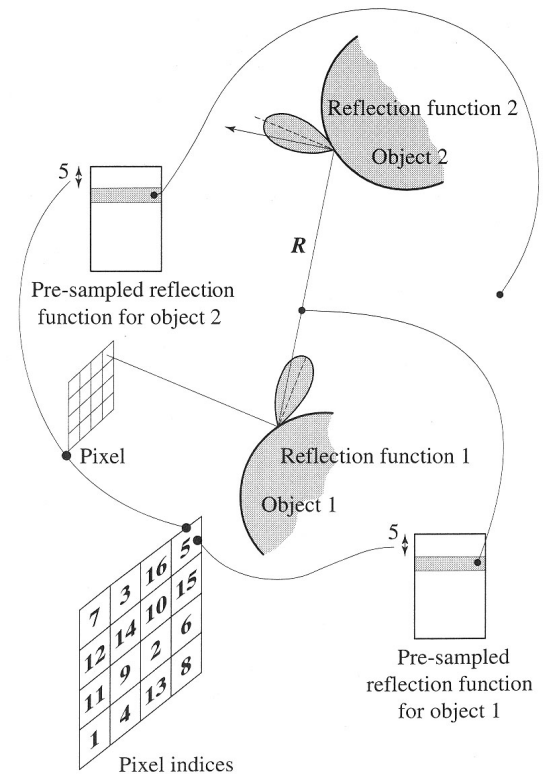

22

Soft shadows

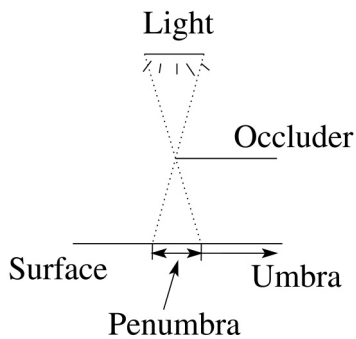

Distributing rays over light source area gives:

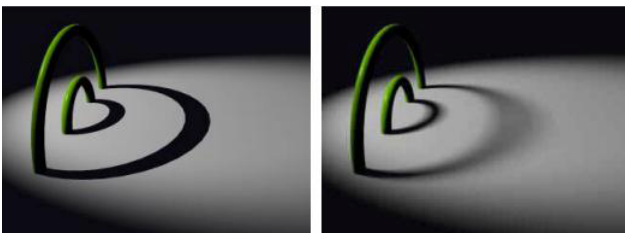

23

The pinhole camera

The first camera - "camera obscura" - known to Aristotle.

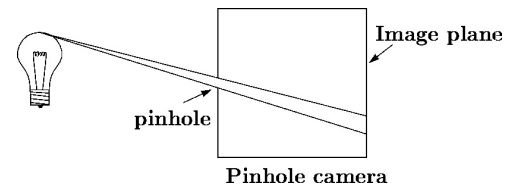

In 3D, we can visualize the blur induced by the pinhole (a.k.a., **aperture**):

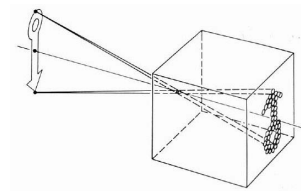

Q: How would we reduce blur?

24

Shrinking the pinhole

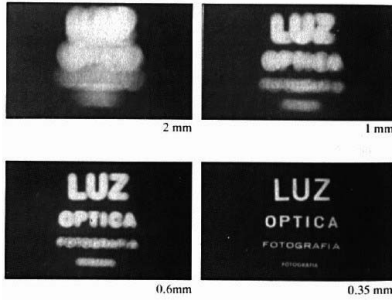

Q: How can we simulate a pinhole camera more accurately?

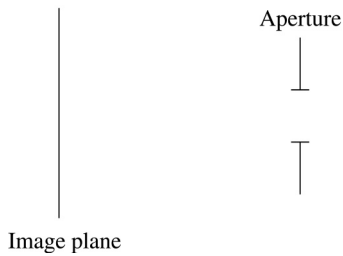

Q: What happens as we continue to shrink the aperture?

25

Shrinking the pinhole, cont'd

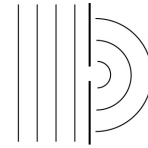

Diffraction

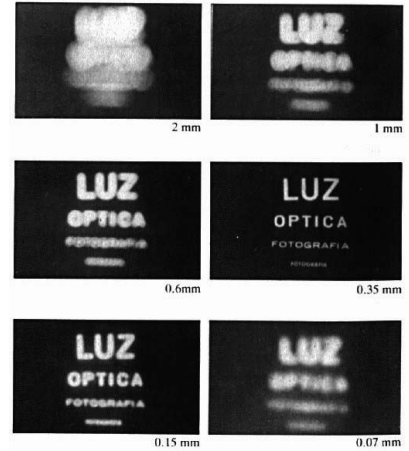

26

Lenses

Pinhole cameras in the real world require small apertures to keep the image in focus.

Lenses focus a bundle of rays to one point => can have larger aperture.

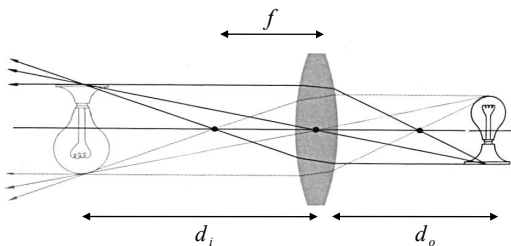

For a "thin" lens, we can approximately calculate where an object point will be in focus using the the Gaussian lens formula:

$$\frac{1}{d_o} + \frac{1}{d_i} = \frac{1}{f}$$

where f is the **focal length** of the lens.

27

Depth of field

Lenses do have some limitations.

The most noticeable is the fact that points that are not in the object plane will appear out of focus.

The **depth of field** is a measure of how far from the object plane points can be before appearing "too blurry."

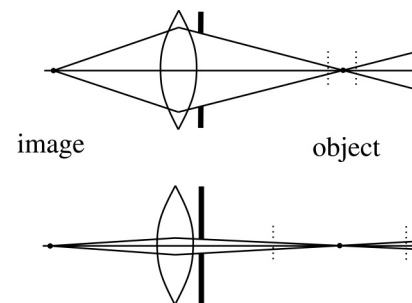

28

Simulating depth of field

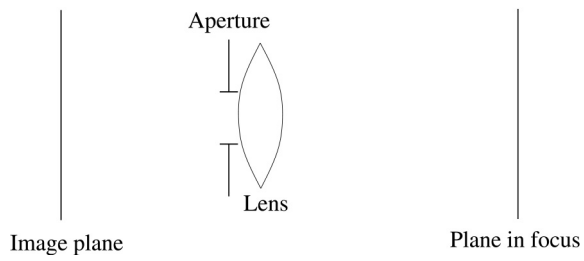

Distributing rays over a finite aperture gives:



29

Chaining the ray id's

In general, you can trace rays through a scene and keep track of their id's to handle *all* of these effects:

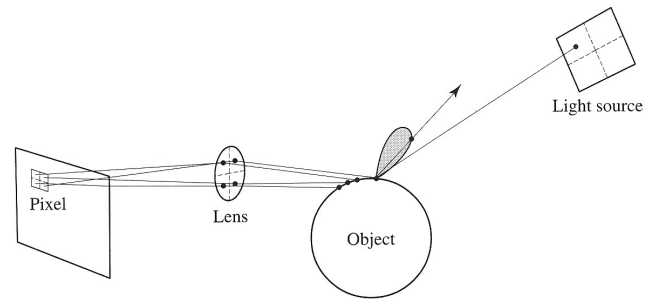

30

DRT to simulate _____

Distributing rays over time gives:

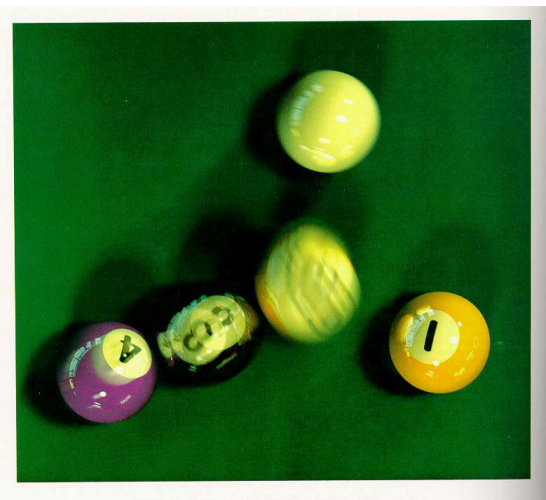

31