

The Birth and Passing of Minicomputers: From A Digital Equipment Corp. (DEC) Perspective

1957-1998. 41 yrs., 4 generations:
transistor, IC, VLSI, clusters - winner take all

How computer classes form...and die.

Not dealing with technology = change = disruption

Gordon Bell

11 October 2006

On History...

1. "God alone knows the future, but only an historian can alter the past." -- Ambrose Bierce
2. "A historian who would convey the truth must lie. Often he must enlarge the truth by diameters, otherwise his reader would not be able to see it."--Mark Twain
3. "The past is malleable and flexible, changing as our recollection interprets and re-explains what has happened." -- Peter Berger
4. "History, a distillation of rumour." -- Thomas Carlyle
5. "Anyone who believes you can't change history has never tried to write his memoirs." _David Ben Gurion
6. "No harm's done to history by making it something someone would want to read." -- David McCullough
7. "History is the present. That's why every generation writes it anew. But what most people think of as history is its end product, myth." -- E.L. Doctorow
8. "People always seemed to know half of history, and to get it confused with the other half." -- Jane Haddam
9. "All history becomes subjective; in other words there is properly no history, only biography." -- Ralph Waldo Emerson

Digital's Trials by Technology...

With time, "high" tech becomes a commodity.

"DEC found guilty of violating Moore's Law ..." –gbell

1. Designing and building first transistor circuits. 1957-1965
2. Transition to integrated circuits & modulo 8 bits 1965-1975
3. Design with VLSI; *manufacturing VLSI* 1975-2002
4. Design of "clusters" as the ultimate computer 1983- ????
5. **Quadruple whammy c1983** – "killer" micros, UNIX: PC, Workstations, CMOS AND UNIX , as "standards"
Anyone can manufacturer computers in their dorm!
"You mean to say, our new ECL mainframe is not equal to our latest CMOS chip?" –Ken Olsen c1990
6. **Fail to exploit: networks, WWW, printers, clusters...**

<http://research.microsoft.com/users/gbell/Digital/DECmuseum.htm>

1. Bell's Law that opens the page and is on my page and Wikipedia. I will open with a bit about laws.
2. Computer, October 1984 that gives the coming and going of the 100 mini companies. 1984 was the time of transition to micros. Startups used UNIX and micros that had performance competitive with minis. Also note my article in Science on "Multis" is important because it became the standard g0t computers.
3. [Listing of Minicomputer companies 1960-1984 and super-minicomputer and mini-supercomputer companies 1984-1995.](#)
4. [Digital 41 Year History CD](#) published 30 April, 1998 with key events and timeline... with photos and facts about machines (alpha to PDP-1), module, the mill, and people! A nice reference with time, bullets, and photos.
5. [COMPUTER ENGINEERING](#) Bell, C. G., C. Mudge, J. McNamara., Digital Press 1978 has the origin of DEC from the circuits that came from MIT Lincoln Laboratory. It has the story of how the PDP-5 was created as a component. PDP-5 begot the PDP-8 that was the "classic" or archetypical mini. The same story can be told about micros as components.
6. [The Bell Appendix for Edgar H. Schein's book "DEC is Dead, Long Live DEC"](#) Berett-Koehler Publishers, San Francisco, 2003. The appendix describes Bell's view of What Happened such that Digital was first sold to Compaq in 1998 and then to HP in 2002. Digital aka DEC was only 41 years old. It has some technology, but it is management too. I am not a fan of Christian's use of DEC as the poster child to illustrate Innovator's Dilemma or disruptive technology...
7. Note the [VAX Strategy](#), similar to the IBM 360 plan, and then Sun's "All the wood behind one arrow".
8. Note the transition to distributed computing and the Ethernet presentation. [The complete Ethernet Announcement by Bell \(Digital\), Noyce \(Intel\), and Liddle \(Xerox\) slides and script](#) (PDF 7MB) was made in New York City on February 10, 1982 by the DIX group, followed by announcements in Amsterdam, and London. Note my presentation included: "[the network becomes the system](#)"... Can you recall a similar mantra that SUN Microsystems later appropriated?
9. See the three articles on the PDP-11 on "the address space problem":
 - a. Bell, C. G... and W. Wulf, "[A New Architecture for Mini-Computers -- The DEC PDP-11](#)", [SJCC](#), pp. 657-675 (1970).
 - b. [What we learned from the PDP-11](#), published by myself and Bill Strecker in 1975.
 - c. [Retrospective on the PDP-11](#) Bill Strecker with a retrospective about VAX and Alpha, 1995.
10. [Family Tree of Digital's Computers Poster](#) created in 1980, shows the evolution of all of all computer models and times they were introduced since 1960... my favorite way to represent history
Bob Supnik has simulators for the DEC machines [Papers on Simulation and Historic Systems](#).
Searching for specific machines and people usually get a lot more than you want or need. E.g. <http://www.pdp8.org/>, www.pdp11.org, www.pdp10.org, www.vax.org are sites about specific minis including simulators. http://en.wikipedia.org/wiki/Digital_Equipment_Corporation lists all the machine families.

The 41 year life and trials of Digital Equipment Corp. aka DEC

- **1960: Birth of DEC from MIT Lincoln Lab... its evolution**
- 1965-1984+?: Birth and death of the minicomputer industry built with LSI to be replaced by multiple, microprocessors
- **Theory: Bell's Law (of Computer Classes)**
- 1978: VAX and the VAX Strategy to become number 2
- 1985-: PCs, workstations, “killer micros” and standards take on all comers
- **The DEC Organization and Culture... What happened?**
- **Summary...**

- Stories
 - PDP-1; ITT Store & Forward Switch... UART
 - PDP-6 from PDP-3. Compiler
 - PDP-5 how it was created & PDP-8
 - PDP-11 at CMU
 - VAX and VAX Strategy ... address bit problem
 - Ethernet DIX, Liddle,

Digital's aka DEC's Origin and Plan ...

1957: Ken Olsen, Harlan Anderson, Stan Olsen --
leave MIT's Lincoln Laboratory as transistor
circuit and computer designers; collect \$70K
from American Research and Development –VC

Business plan: design, manufacture, sell logic
modules... and eventually use the earnings and
modules for building computers

See also www.computerhistory.org

<http://research.microsoft.com/users/gbell/Digital/DECmuseum.htm>

Movie celebrating the PDP-1 Birth, Spacewar, etc.

<http://www.computerhistory.org/events/index.php?id=1142978073>

Some Financial & Size, Dates, Factoids

- 1957: Founded @ \$70K. 5 Mhz logic modules. Profitable 1st yr @ \$94K. 60p. Ken Olsen, CEO & Ben Gurley, PDP-1 @ \$14K
- 1959: Memory test equipment using system modules;
- 1960: 1st. **PDP-1** delivery to BBN;
- 1964: \$1.8M R&D, 1/6 of revenue
- 1965: \$15M. **PDP-5 (the Mini), PDP-6 (Timesharing);** 1966: \$23M;
- 1971: \$147M. **PDP-11;** 1972: 7.8Kp, \$200M; 1977: **\$1B** 38Kp;
- 1978: **VAX & VAX Strategy;** 1979: \$1.8b; 1980: 200KC, \$2B;
- 1982: **VAX Clusters.** \$4B, 369KC, 67Kp, Fortune 137th; 1984: \$5B,
- 1988 120Kp largest in MA&NH; 62 countries, 475 sales offices
\$11.4B revenue, \$1.3 billion in net profits, market cap \$23.9 billion (10th in US), Fortune 38. NUMBER 2!
- 1992: **Alpha,** Bob Palmer, former VP DEC Semis, appointed CEO
- 1998: Compaq Acquires DEC @ age 41. All except Palmer lose!
- 2002: HP acquires Compaq.

First DEC Building Blocks and Logic Modules

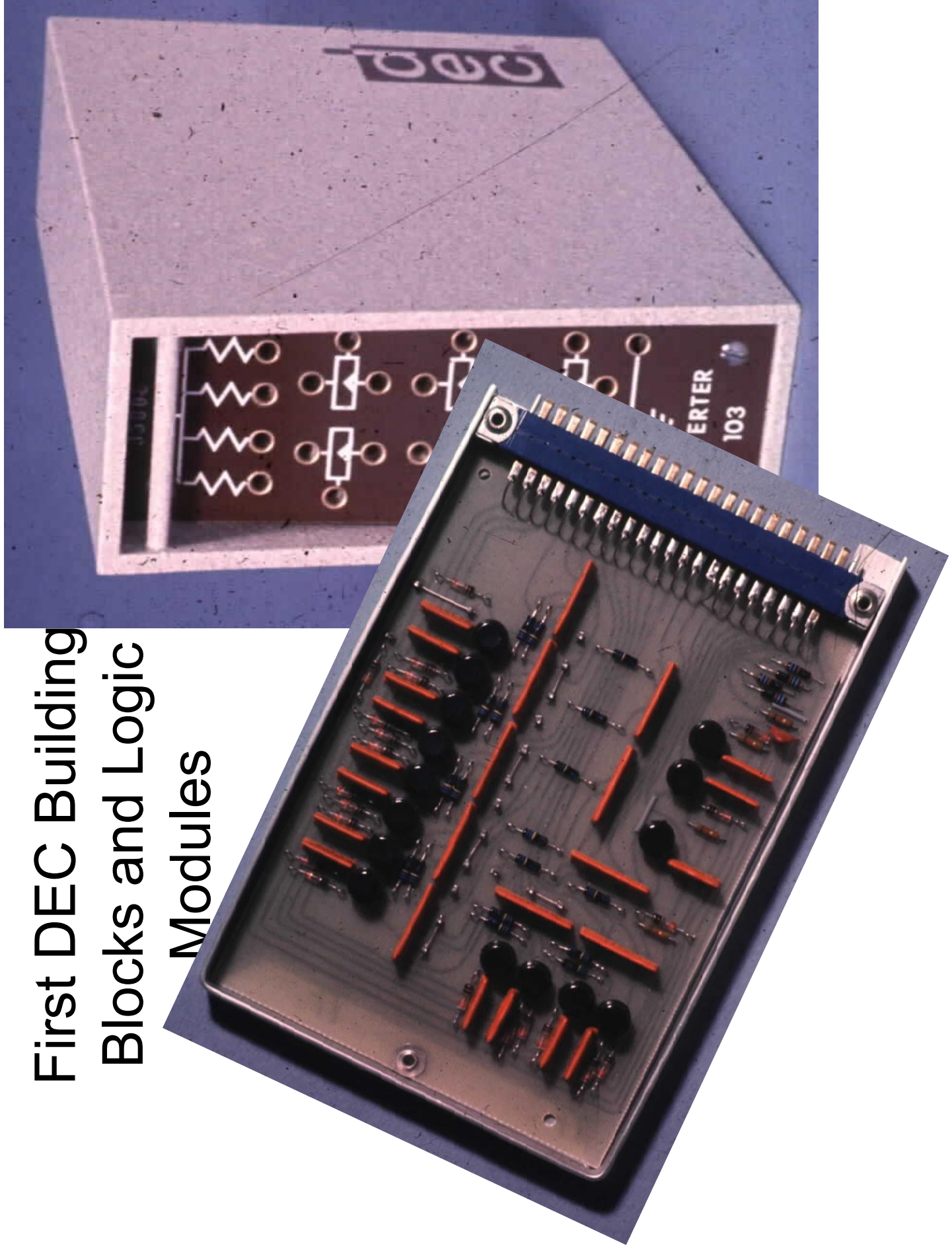

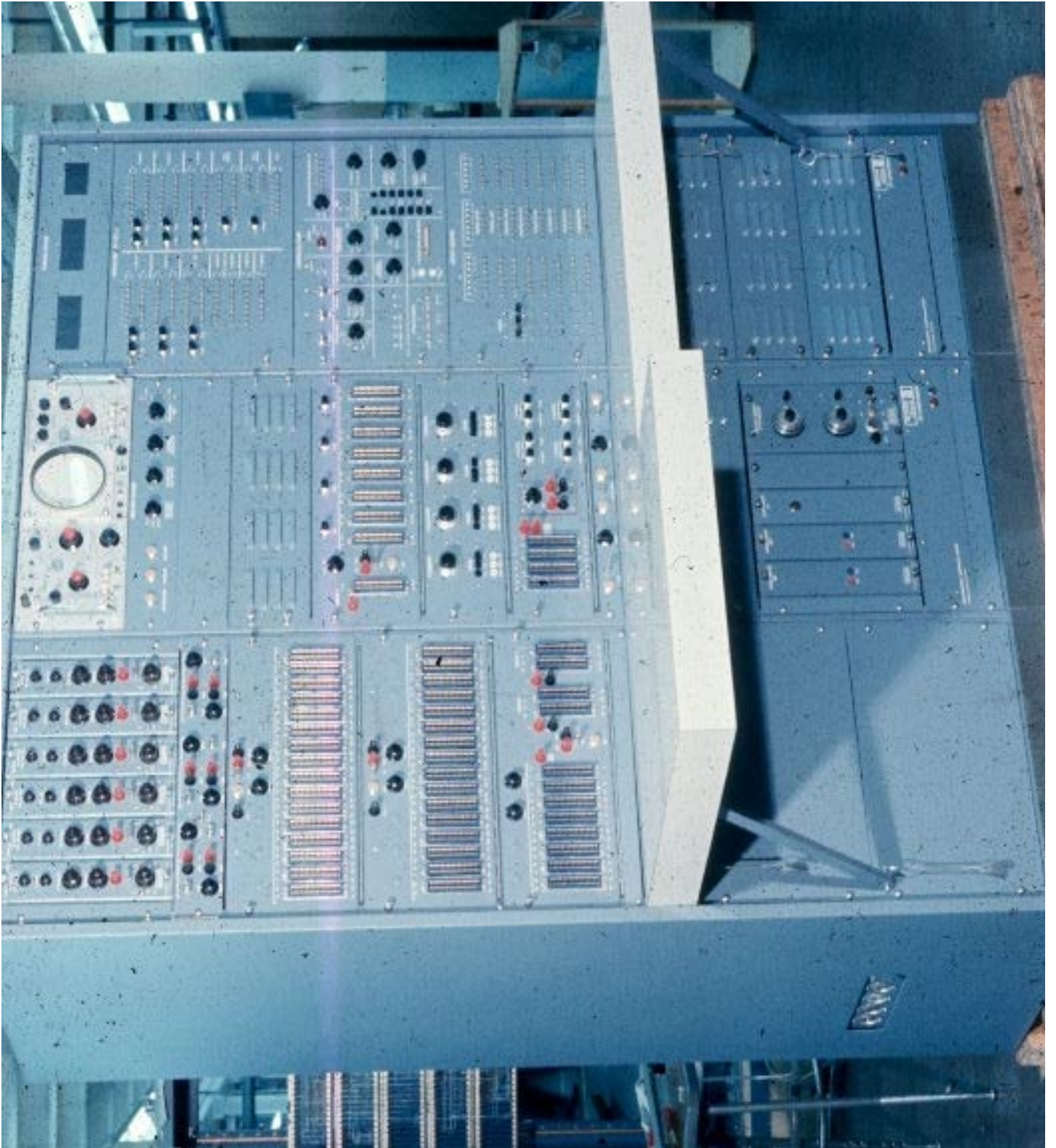



PDP-1 prototype with
separate console. 18 bit
word... patterned after
Lincoln Lab TX-0
40 were sold
ITT: message switching

STANDARD PDP-1

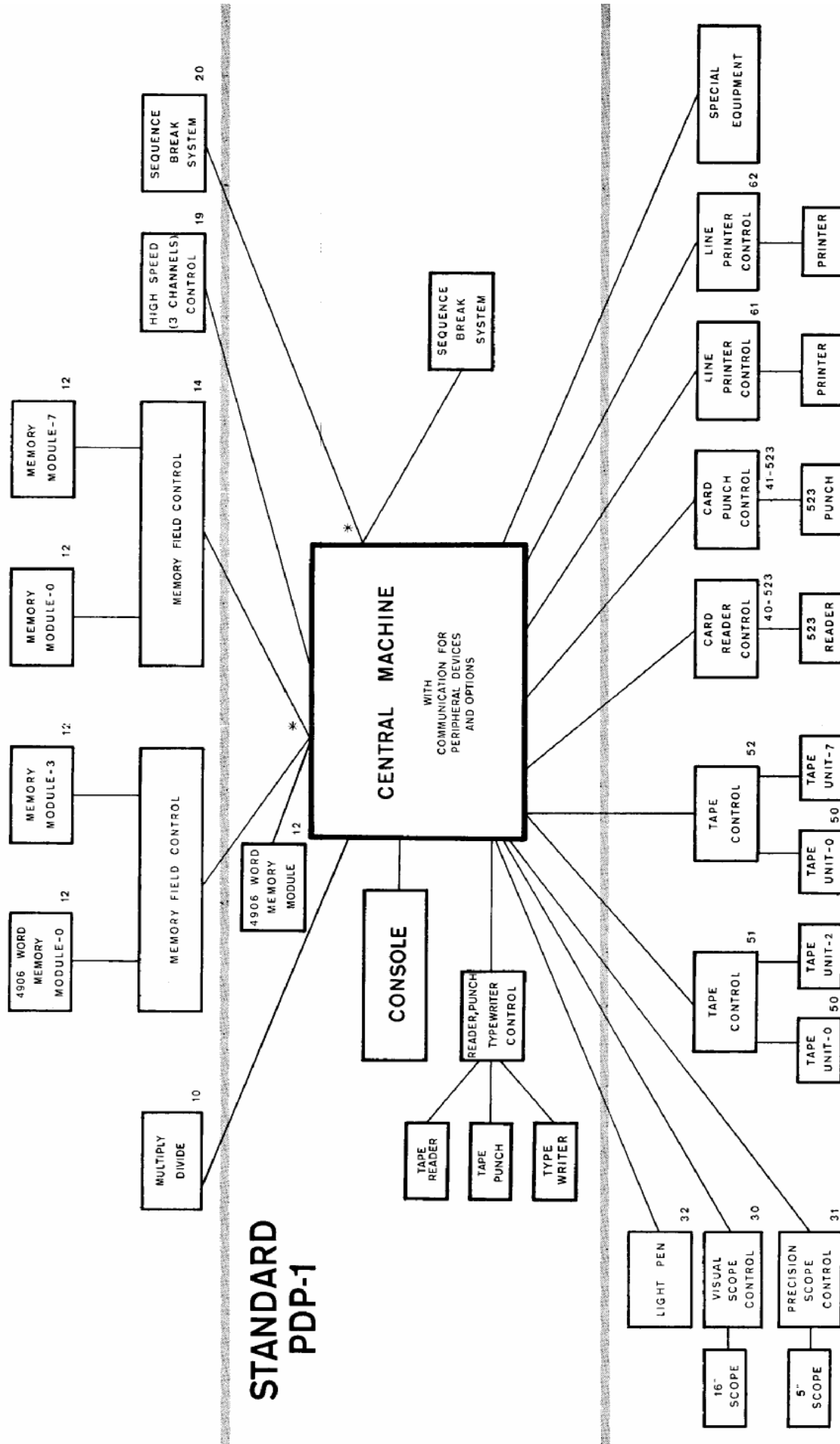

INPUT-OUTPUT OPTIONS

NOTE:
 OUTER NUMBERS DENOTE OPTION TYPES
 * ONLY ONE OPTION MAY BE CONNECTED FOR A MACHINE

PDP-5

Initial design was for data collection for an experimental reactor in Canada... A/D, I/O bus, 12-bit word



GROUP 1 OPERATE MICROINSTRUCTIONS

Mnemonic Symbol	Octal Code	Event Time	Operation
nop	7000	—	No operation. Causes a 12 μ sec program delay.
iac	7001	3	Index AC. $C(AC) + 1 = > C(AC)$
ral	7004	2	Rotate the C(AC) and the C(L) left one place. $C(AC)_i = > C(AC)_{i-1}$ $C(L) = > C(AC)_{i1}$ $C(AC)_0 = > C(L)$
rtl	7006	2, 3	Rotate two left.

MEMORY REFERENCE INSTRUCTIONS

Mnemonic Symbol	Operation Code	Time (μ sec)	Operation
and Y	0	18	Logical AND. The AND operation is performed between the C(Y) and the C(AC). $C(Y)_i \wedge C(AC)_i = > C(AC)_i$.
tad Y	1	18	Twos complement add. The C(Y) are added to the C(AC) in twos complement arithmetic. $C(Y) + C(AC) = > C(AC)$.
isz Y	2	18	Index and skip if zero. The C(Y) are incremented by one in twos complement arithmetic. If the resultant C(Y) = 0, the next instruction is skipped. $C(Y) + 1 = > C(Y)$. If result = 0, $C(PC) + 1 = > C(PC)$.
dca Y	3	18	Deposit and clear AC. The C(AC) are deposited in core memory location Y and the AC is cleared. $C(AC) = > C(Y)$, then $0 = > C(AC)$.
jms Y	4	24	Jump to subroutine. The C(PC) are deposited in core memory location Y. The next instruction is taken from location Y + 1. $C(PC) + 1 = > C(Y)$ $Y + 1 = > C(PC)$
jmp Y	5	12	Jump to Y. The C(PC) are set to address Y. The next instruction is taken from core memory location Y. $Y = > C(PC)$.

GROUP 2 OPERATE MICROINSTRUCTIONS

Mnemonic Symbol	Octal Code	Event Time	Operation
hit	7402	3	Halt. Stops the program.
osr	7404	3	OR with Switch Register $C(SR) \vee C(AC) = > (CAC)$
skp	7410	1	Skip, unconditional. $C(PC) + 1 = > C(PC)$
snl	7420	1	Skip on non-zero L. If $C(L) = 1$, then $C(PC) + 1 = > C(PC)$
szl	7430	1	Skip on zero L. If $C(L) = 0$, then $C(PC) + 1 = > C(PC)$
sza	7440	1	Skip on zero AC. If $C(AC) = 0$, then $C(PC) + 1 = > C(PC)$
sna	7450	1	Skip on non-zero AC. If $C(AC) \neq 0$, then $C(PC) + 1 = > C(PC)$
sma	7500	1	Skip on minus AC. If $C(AC)_0 = 1$, then $C(PC) + 1 = > C(PC)$
spa	7510	1	Skip on positive AC. If $C(AC)_0 = 0$, then $C(PC) + 1 = > C(PC)$
cla	7600	2	Clear AC $0 = > C(AC)$

A computer that grows with you

**Business Week,
March 1964
(recall 4/7/1964)**

Latest machine is designed to serve 128 terminals at once, and to have subsystems added as required. Called the PDP-6, it's made by company that serves mainly scientists



A very small company this week unveiled a computer that, in some respects, is the biggest ever.

Digital Equipment Corp., of Maynard, Mass., put the machine together. It's called the PDP-6, and it costs \$2-million if you want all the available bells and whistles. And these are considerable, particularly its outsized central memory with a capacity of 262,000 words (compared with 64,000 in the larger IBM scientific computers), which, among other things, allows the PDP-6 to serve up to 128 input-output stations simultaneously.

Most computers are designed to work one problem after another, very fast. What's unusual about the PDP-6 is that it is designed to work on a whole lot of problems at once, though at moderate speed. Digital Equipment believes it is the first commercially available computer to offer time-sharing and multi-processing as standard features—a concept that for years has fascinated computer experts at MIT [BW Feb. 1'64,54], as well as DEC's scientist executives.



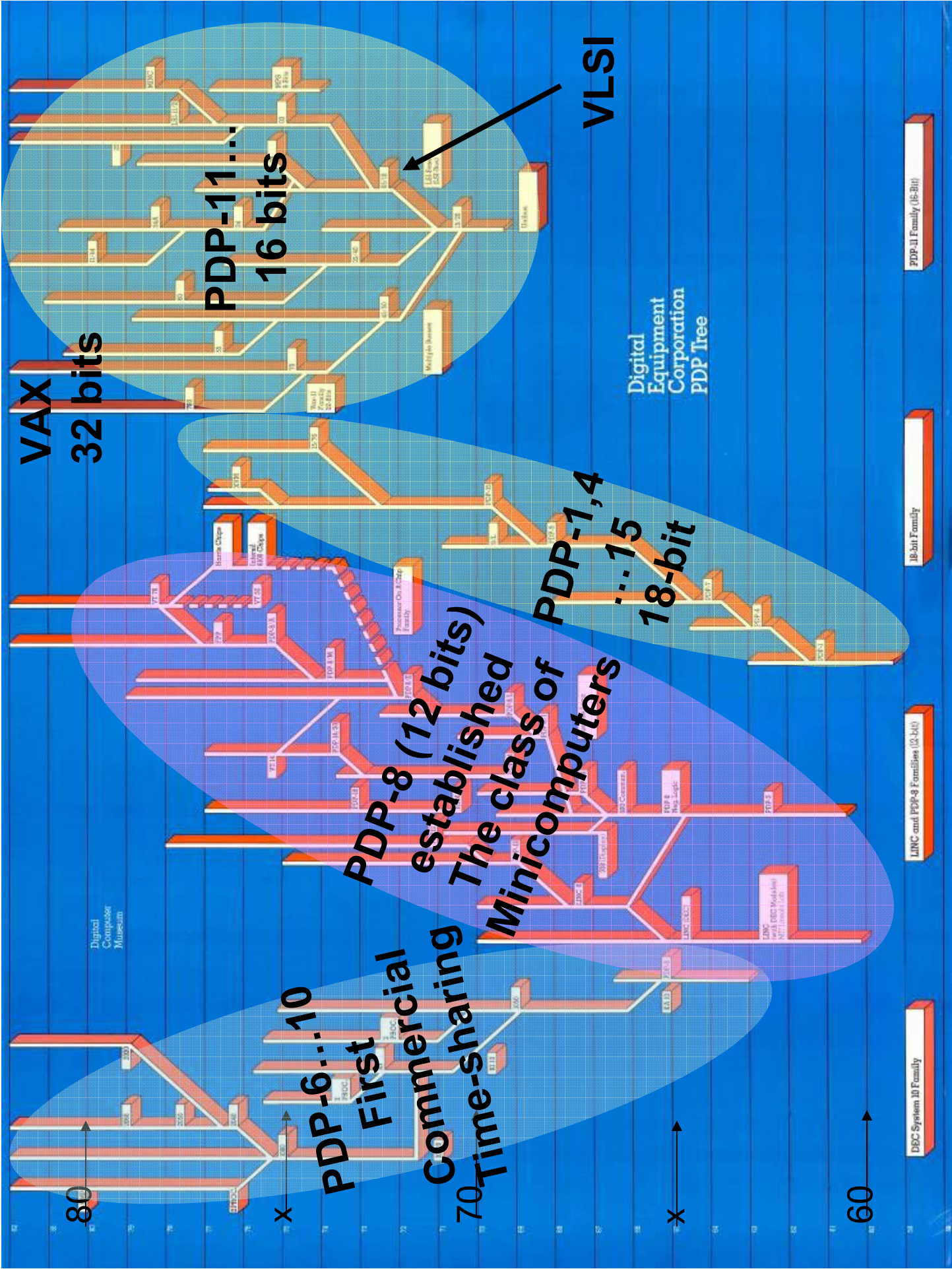

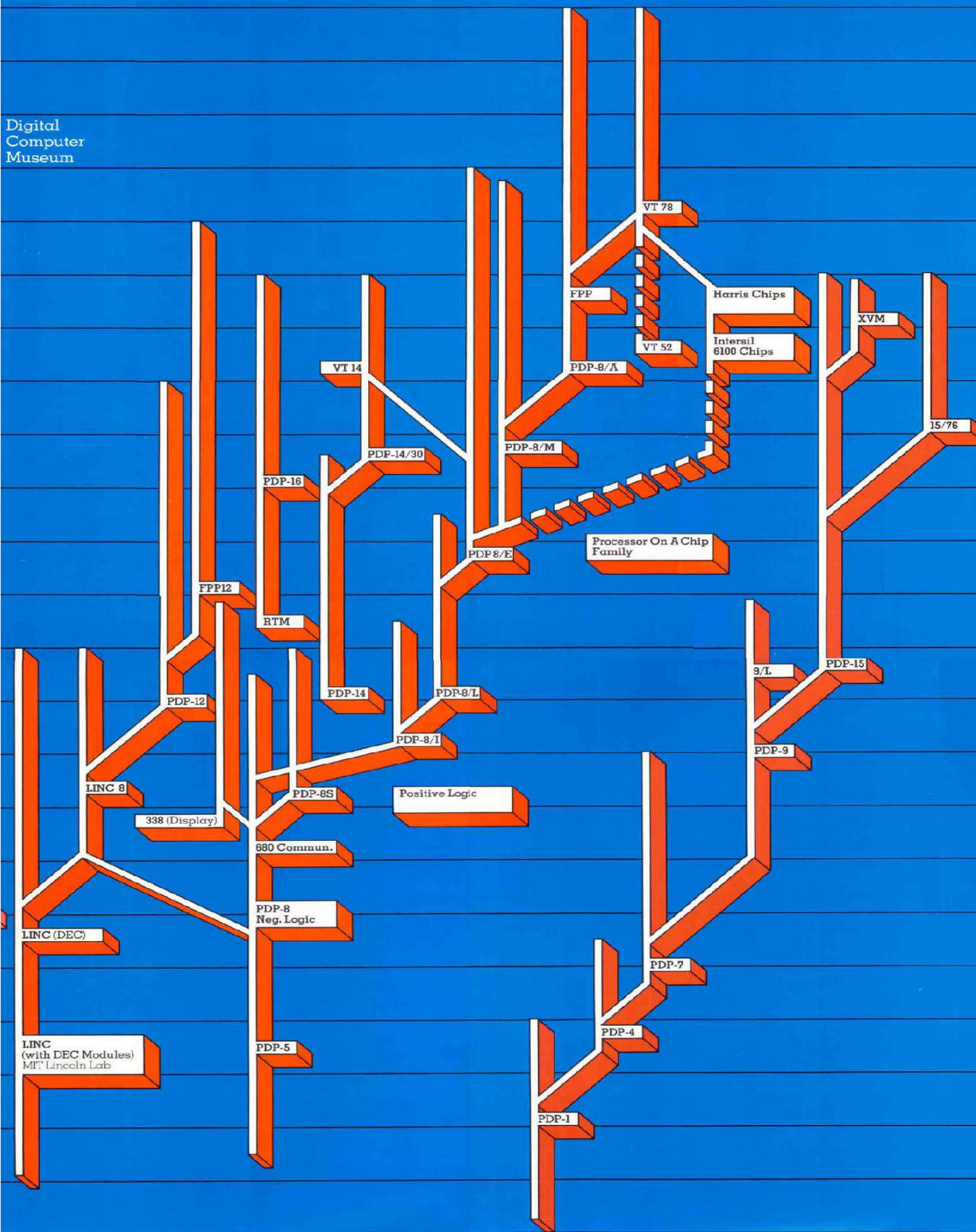

LINC and PDP-8 Families (12-bit)

18-bit Family

The 41 year life and trials of Digital Equipment Corp. aka DEC

- 1960: Birth of DEC from MIT Lincoln Lab... its evolution
- **1965-1984+?: Birth and death of the minicomputer industry**
Shift to 8 bit word with introduction of the IBM System 360.
- **Theory: Bell's Law (of Computer Classes)**
- 1978: VAX and the VAX Strategy to become number 2
- 1985-: PCs, workstations, “killer micros” and standards take on all comers
- **The DEC Organization and Culture... What happened?**
- **Summary...**
- **Stories**
 - PDP-1; ITT Store & Forward Switch... UART
 - PDP-6 from PDP-3. Compiler
 - PDP-5 how it was created & PDP-8
 - PDP-11 at CMU
 - VAX and VAX Strategy... address bit problem
 - Ethernet DIX; Liddle,

Tech/Computer Generations

- 1947 Transistor
- 1958 IC
- 1971 4004 Microprocessor
- 1960 1st Trans. Comp.; 64' 8bits
- 1979-83 Ethernet/LANs (DIX)
- 1966 1st IC Computers
- 1965-85+ Mini era (100 companies)
- 1975 1st Micro- computers
- 1981,4 IBM PC, MAC; u's & UNIX
- 1988 – clusters = the computer
- 1992 – WWW; 1000s of micros
- 1960 DEC PDP-1
- 1965 DEC PDP-5 (mini archetype); DEC PDP-6 (timesharing)
- 1970, 75 DEC PDP-11, LSI-11
- 1978; 84; 92 DEC VAX; uVAX, Alpha
- 1982 DEC PCs
- 1983 DEC VAX Clusters.. VAX strategy
- 1992 DEC Altavista

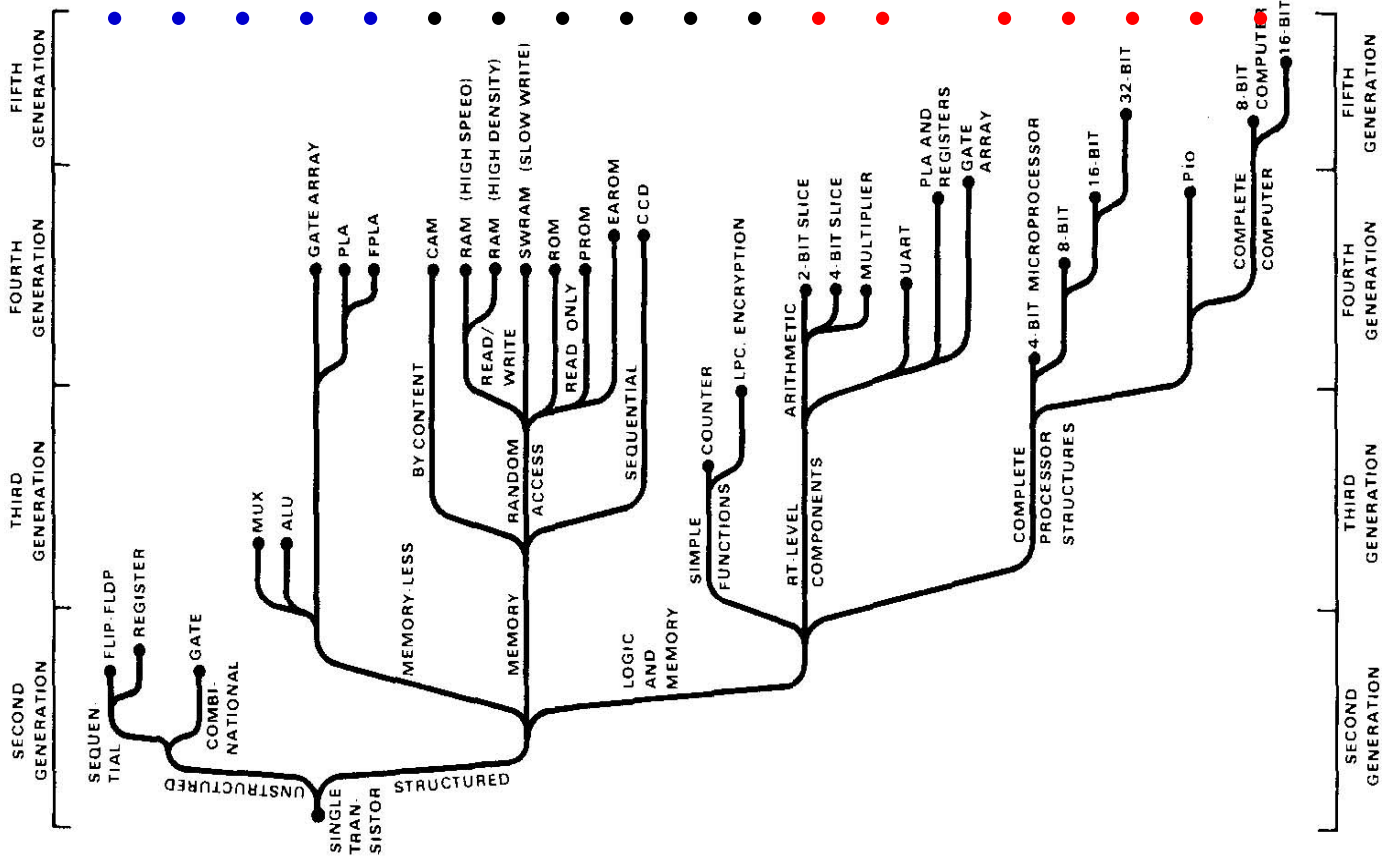

Minicomputer definitions c1970, 71 with introduction of PDP-11

	<i>primary memory (words)</i>	<i>(1970 kilodollars)</i>	<i>(bits)</i>
micro	8 K	~ 5	8 ~ 12
mini	32 K	5 ~ 10	12 ~ 16
midi	65 ~ 128 K	10 ~ 20	16 ~ 24

Minicomputers (for minimal computers) are a state of mind; the current logic technology, ..., are combined into a package which has the smallest cost. Almost the sole design goal is to make the cost low; Alternatively stated: the hardware-software tradeoffs for minicomputer design have, in the past, favored software.

HARDWARE CHARACTERISTICS

Minicomputer may be classified at least two ways:

1. It is the minimum computer (or very near it) that can be built with the state of the art technology.
2. It is that computer that can be purchased for a given, relatively minimal, fixed cost (e.g., \$10K in 1970).

91 Minicomputer companies 1984

DG, DEC, HP, IBM... survived by 1990

- 49 started up and retained autonomy
- 2 grew at significant rates and continue to grow
 - Data General, Prime
- 8 grew at diminished or declining rates, or found small niches
 - Adage, Basic 4, Computer Automation, Four Phase, General Automation, Macrodata, Microdata, Modcomp
- 39 ceased to manufacture
 - American Computer Tech., Atron, BIT, Cascade, Compiler Systems, Computer Development Corp., Computer Logic Systems, Computer Properties, Data Mate, Data Technology Corp., Datac, Decade, Digital Electronics, Digital Computer Corp. (ultimately merged with DG), Digital Scientific, Dresser, Electronic Engineering, Foto-Metric, Hetra, Information Technology Inc., Infotronics, Linolex, Micromp, Monitor Data, Multidata, Nanodata, Northeast Data, Nucldata, Omniscamp, Omniscamp Computer, Omnus, Redcor, Scientific Control Corp., Standard Computer Corp., Spiras Systems, TEC, Unicom Inc., Unicomp, Inc., Viatron
- 10 started up and merged with larger companies
- 2 grew at significant rates and continue to grow
 - Interdata → Perkin Elmer, SEL → Gould
- 2 continued and now manufacture niche products
 - Comten → NCR, Datacraft → Harris
- 6 stopped manufacturing minicomputers in the merged division
 - ASI/EMR (Schlumberger), CDC/Honeywell, DMI/Varian/Univac, PDS/EAI, SDS/Xerox/Honeywell, Tempo/GTE
- 8 existing computer companies built minicomputers
- 2 made successful minicomputers and grew rapidly
 - Digital Equipment Corporation, IBM
- 2 continued with diminishing success in minis
 - Bunker-Ramo, CDC
- 4 stopped manufacturing minicomputers
 - GE, Packard-Bell, Recomp, Votac
- 25 existing non-computer companies built minicomputers for backward integration or special system niches
 - 1 acquired an embryonic company in the design state and formed a division to become a highly successful supplier
 - HP acquired Dymec
 - 3 continued to build and now supply minicomputers for niche markets
 - Hughes, Raytheon, Texas Instruments
 - 21 discontinued building minicomputers
 - AC Electronics, Bailey Meter, Beckman Instruments, Cincinnati Milling, Clary, Collins, EAI, Fairchild, Fairchild, Foxboro, GTE, Interstate Electronics, Lockheed, International Telephone and Telegraph, Litton, Motorola, Philco, Ford, RCA, Singer, Teradyne, Westinghouse

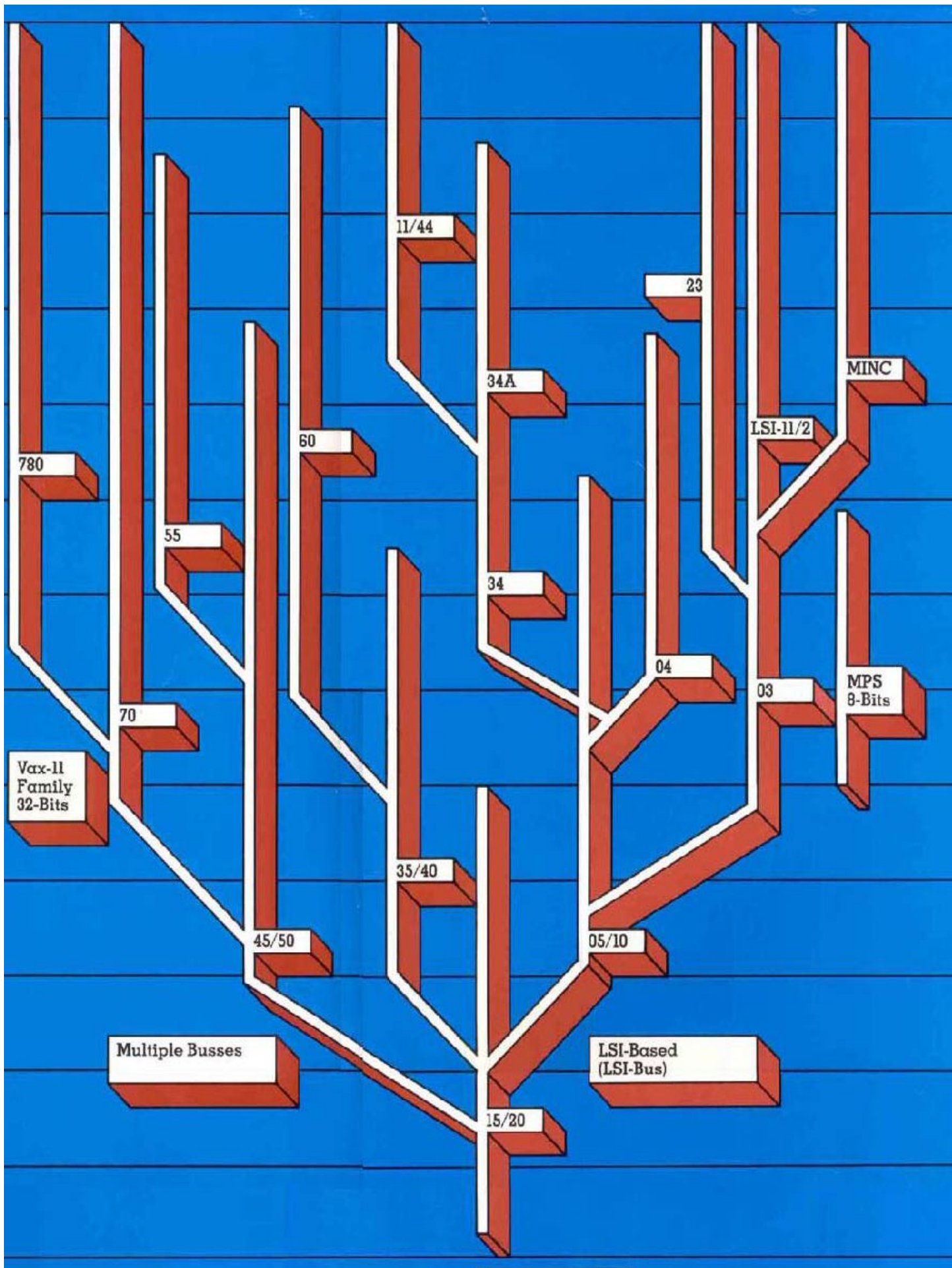

The 41 year life and trials of Digital Equipment Corp. aka DEC

- 1960: Birth of DEC from MIT Lincoln Lab... its evolution
- 1965-1984+?: Birth and death of the minicomputer industry
- **Theory: Bell's Law (of Computer Classes)**
- 1978: VAX and the VAX Strategy to become number 2
- 1985-: PCs, workstations, “killer micros” and standards take on all comers
- **The DEC Organization and Culture... What happened?**
- **Summary...**

- Stories
 - PDP-1; ITT Store & Forward Switch... UART
 - PDP-6 from PDP-3. Compiler
 - PDP-5 how it was created & PDP-8
 - PDP-11 at CMU
 - VAX and VAX Strategy... address bit problem
 - Ethernet DIX, Liddle,

Bell's Law of Computer Classes & their Formation

**the Quest... to move or encode the
entire world into cyberspace**

Computing Laws

Economics-based laws determine the market



- Demand: doubles as price declines by 20%
- Learning curves: 10-15% cost decline with 2X units that enable Moore's Law and other hardware technology evolution



- Bill's Law for the economics of PC software
- Nathan's Laws of Software -- the virtuous circle

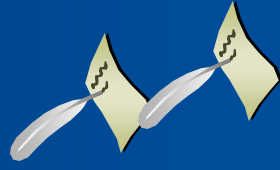

- Metcalfe's Law of the "value of a network"
- Computer classes form and evolve just like modes of transportation, restaurants, etc.

Software Economics: Bill's Law

$$\text{Price} = \frac{\text{Fixed_cost}}{\text{Units}} + \text{Marginal_cost}$$

- Bill Joy's law (Sun): NO software for <100,000 platforms
@ \$10 million engineering expense, \$1,000 price
- Bill Gate's law: NO software for <1,000,000 platforms
@ \$10M engineering expense, \$100 price
- Examples:
 - UNIX versus Windows NT: \$3,500 versus \$500
 - Oracle versus SQL-Server: \$100,000 versus \$6,000
 - No spreadsheet or presentation pack on UNIX/VMS/...
 - Commoditization of base software and hardware

The Virtuous Economic Cycle that drives the PC industry

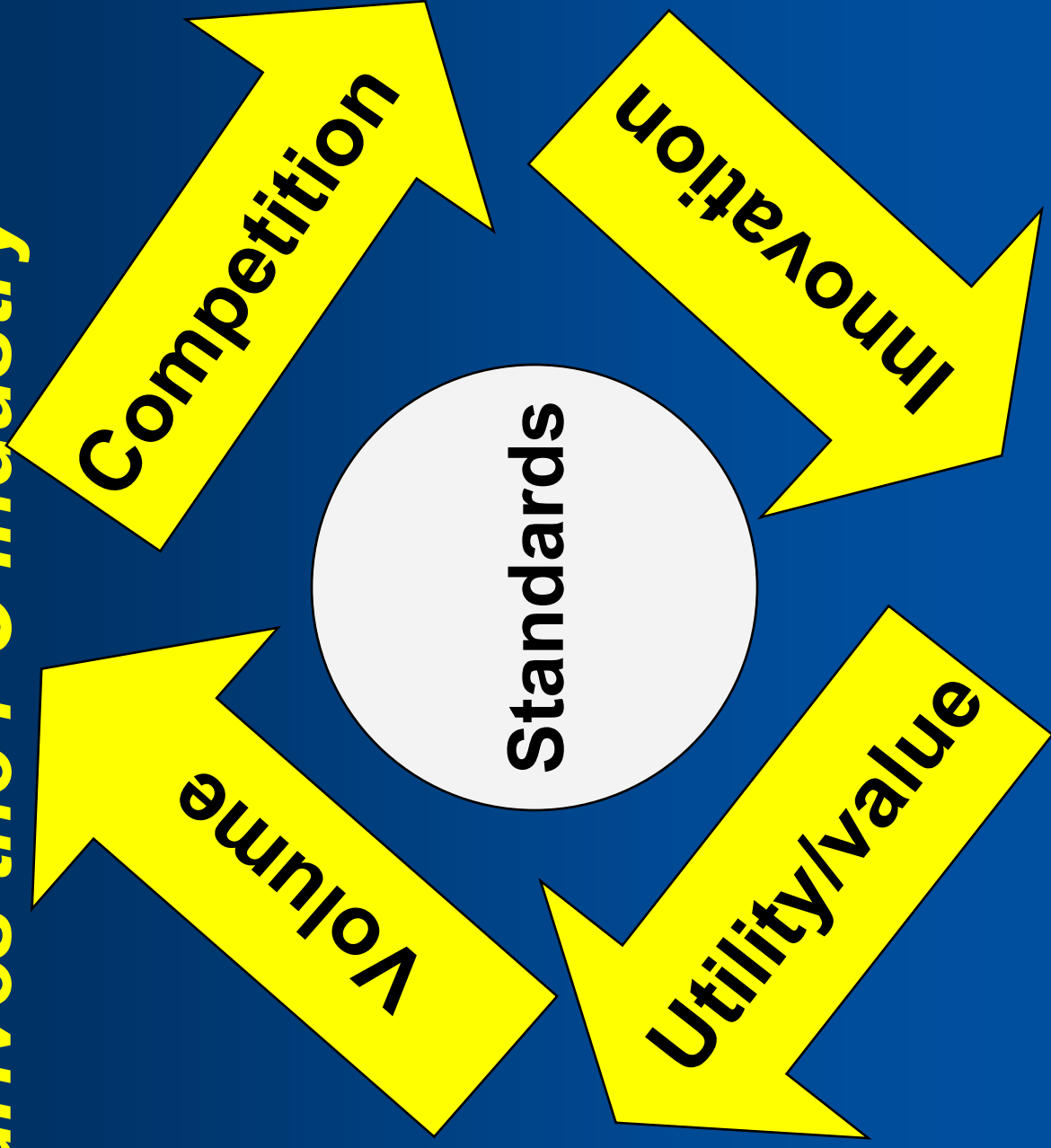



Moore's First Law

- Transistor density doubles every 18 months
60% increase per year
 - Chip density transistors/die
 - Micro processor speeds
- Exponential growth:
 - The past does not matter
 - 10x here, 10x there ... means REAL change
- PC costs decline faster than any other platform
 - Volume and learning curves
 - PCs are the building bricks of all future systems

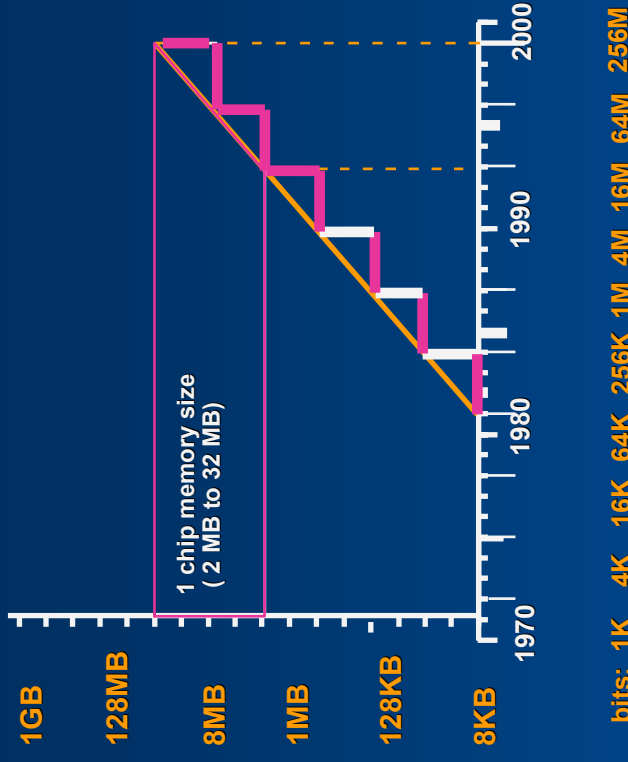

Computer components must all evolve at the same rate

- Amdahl's law: one instruction per second requires one byte of memory and one bit per second of I/O
- Storage evolved at 60%; after 1995: 100
- Processor performance evolved at 60%.
 - Clock Performance flat >1995 until multi-cores
 - Multi processors.
 - Graphics Processing Unit to exploit parallelism
- Wide Area Network speed evolved at >60%
- Local Area Network speed evolved 26-60%
- Grove's Law: Plain Old Telephone Service

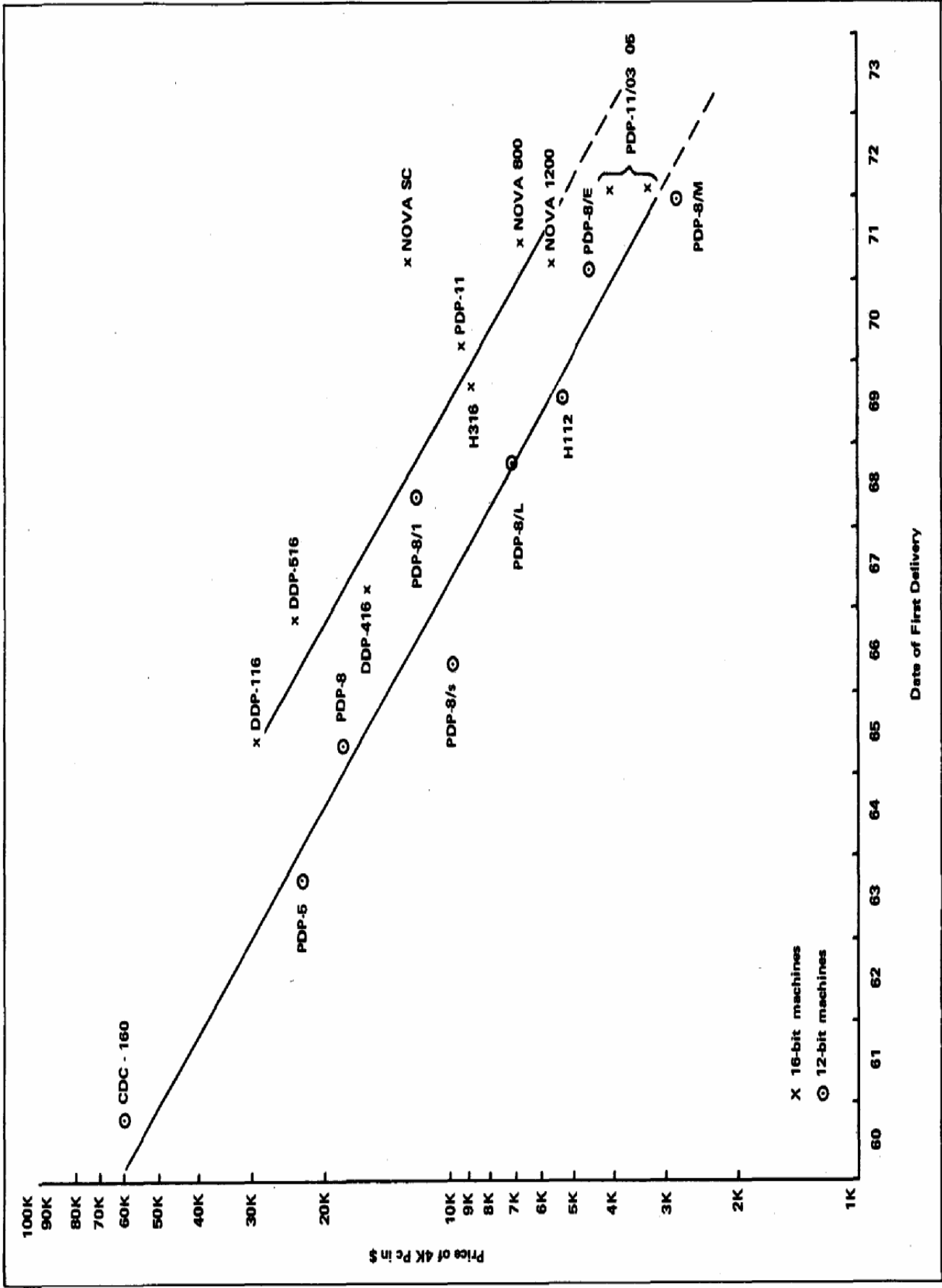
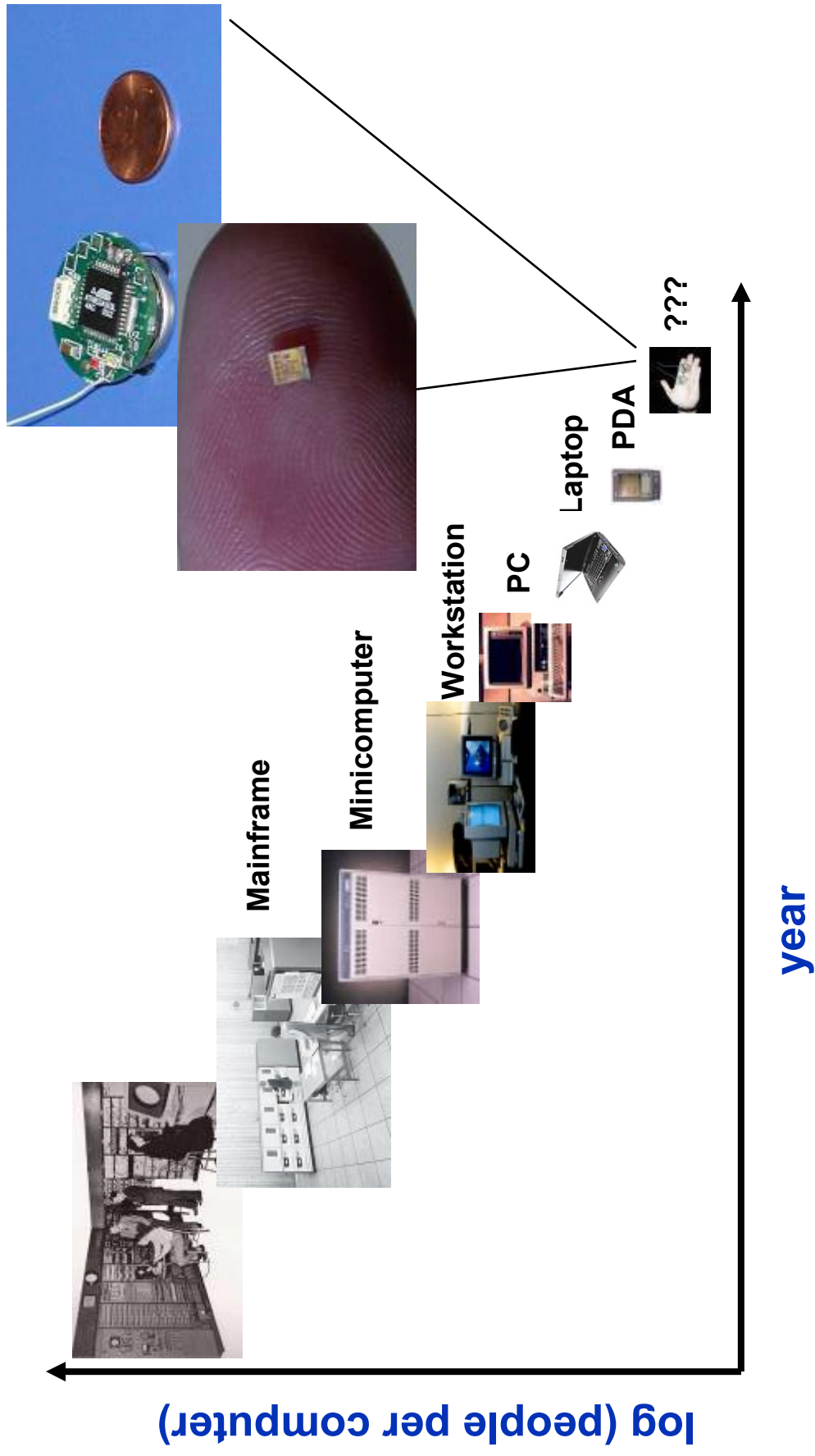
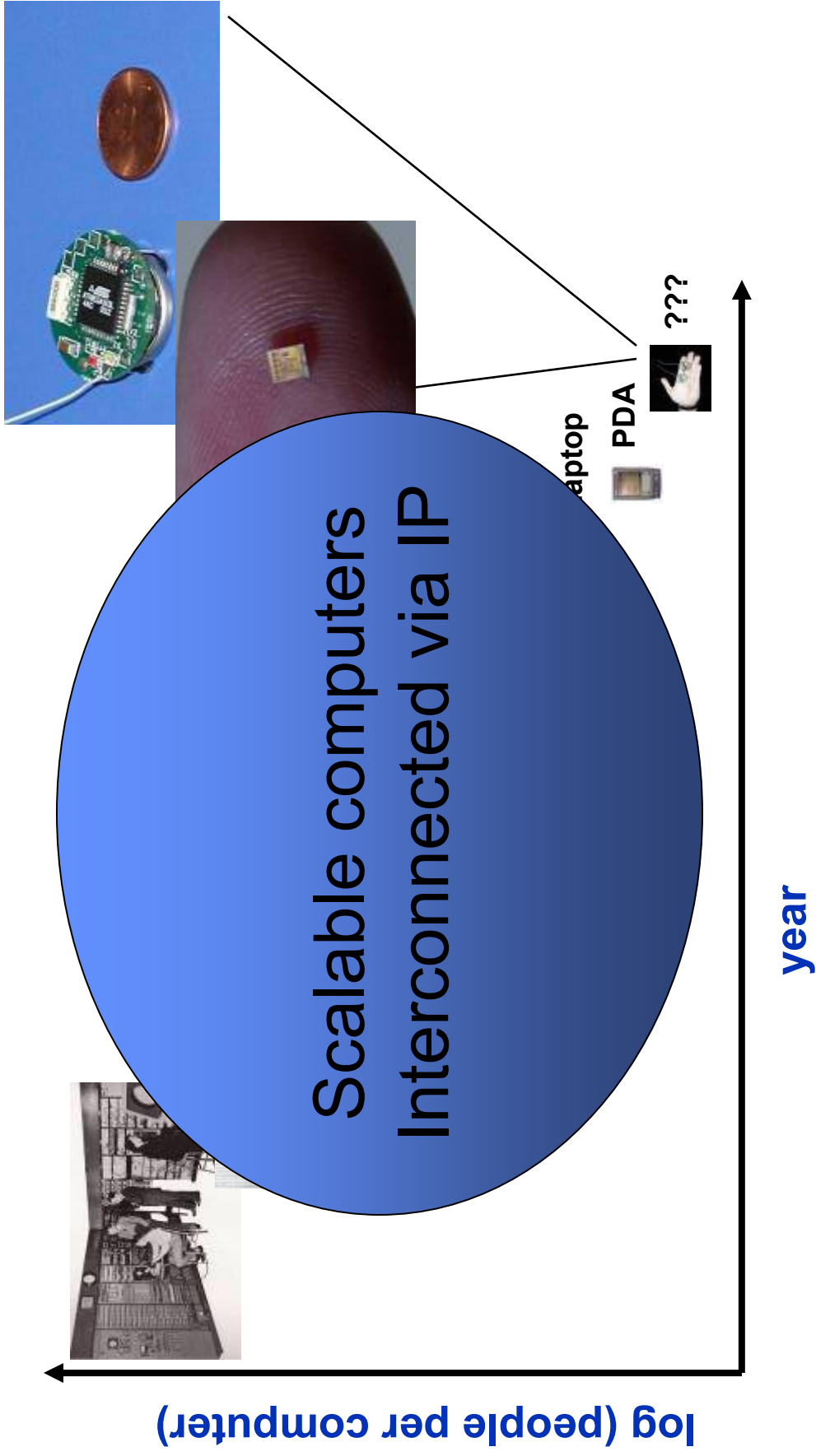

Fig. 1. Plot of cost of 12 and 16 bit machines, based on 4K Pc's, beginning in 1960 and extended through 1970. (Data taken from House and Henzel, 1971, courtesy of Computer Design Magazine.)

The classes, sans phones, 2006



The classes, sans phones, 2006



Bell View 1985 with the intro of Multis

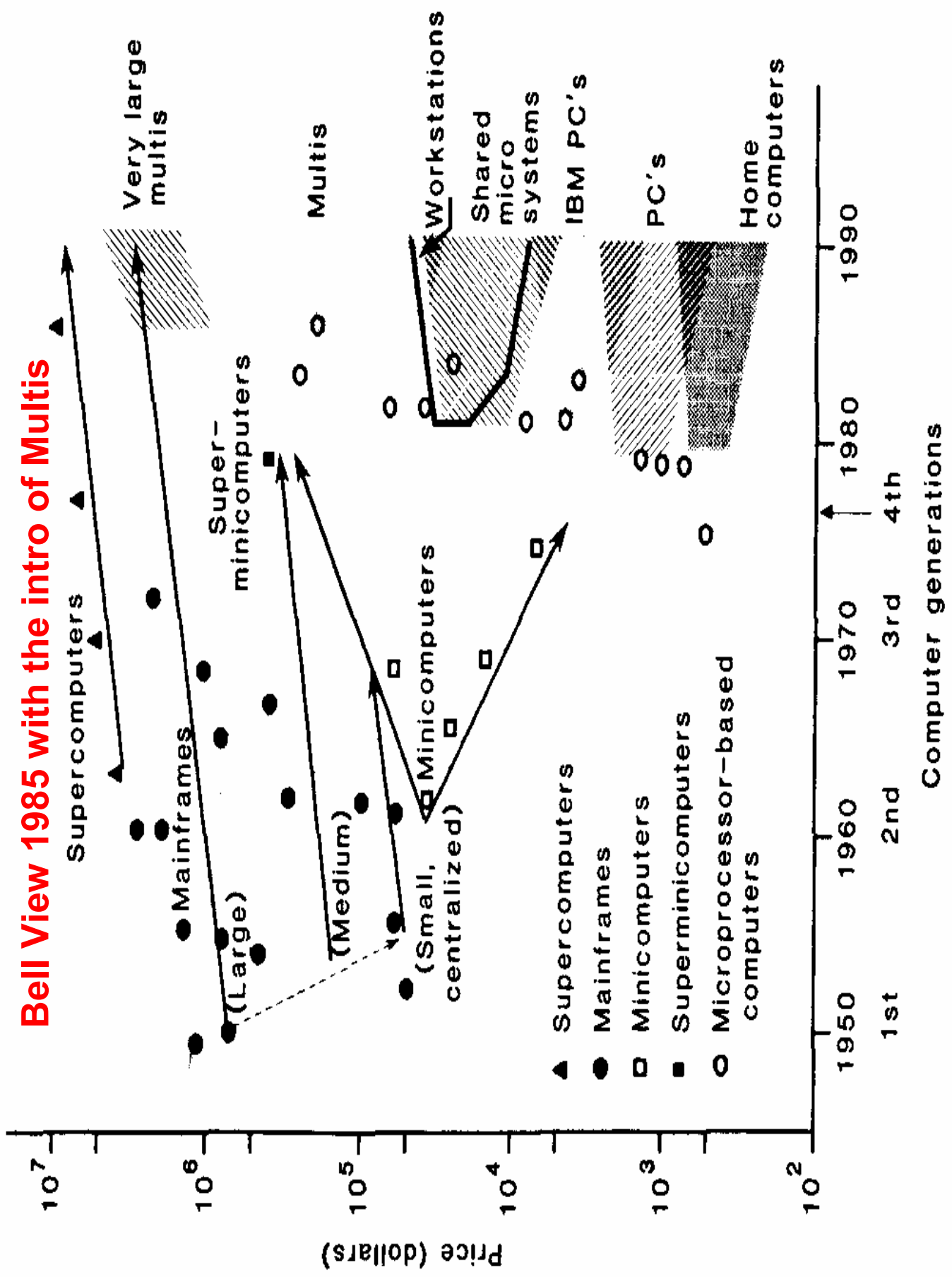

How Will Future Computers Be Built?

Thesis: **SNAP: Scalable Networks and Platforms**

- upsize from desktop to world-scale computer
- based on a few standard components

Because:

- Moore's law: exponential progress
- Standardization & commoditization
- Stratification and competition

When: Sooner than you think!

- massive standardization gives massive
- economic forces are enormous

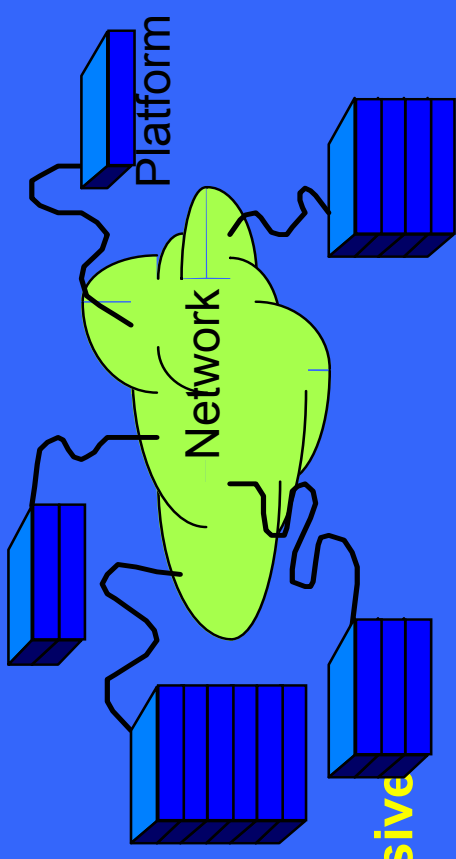

Class conflict with SNAP

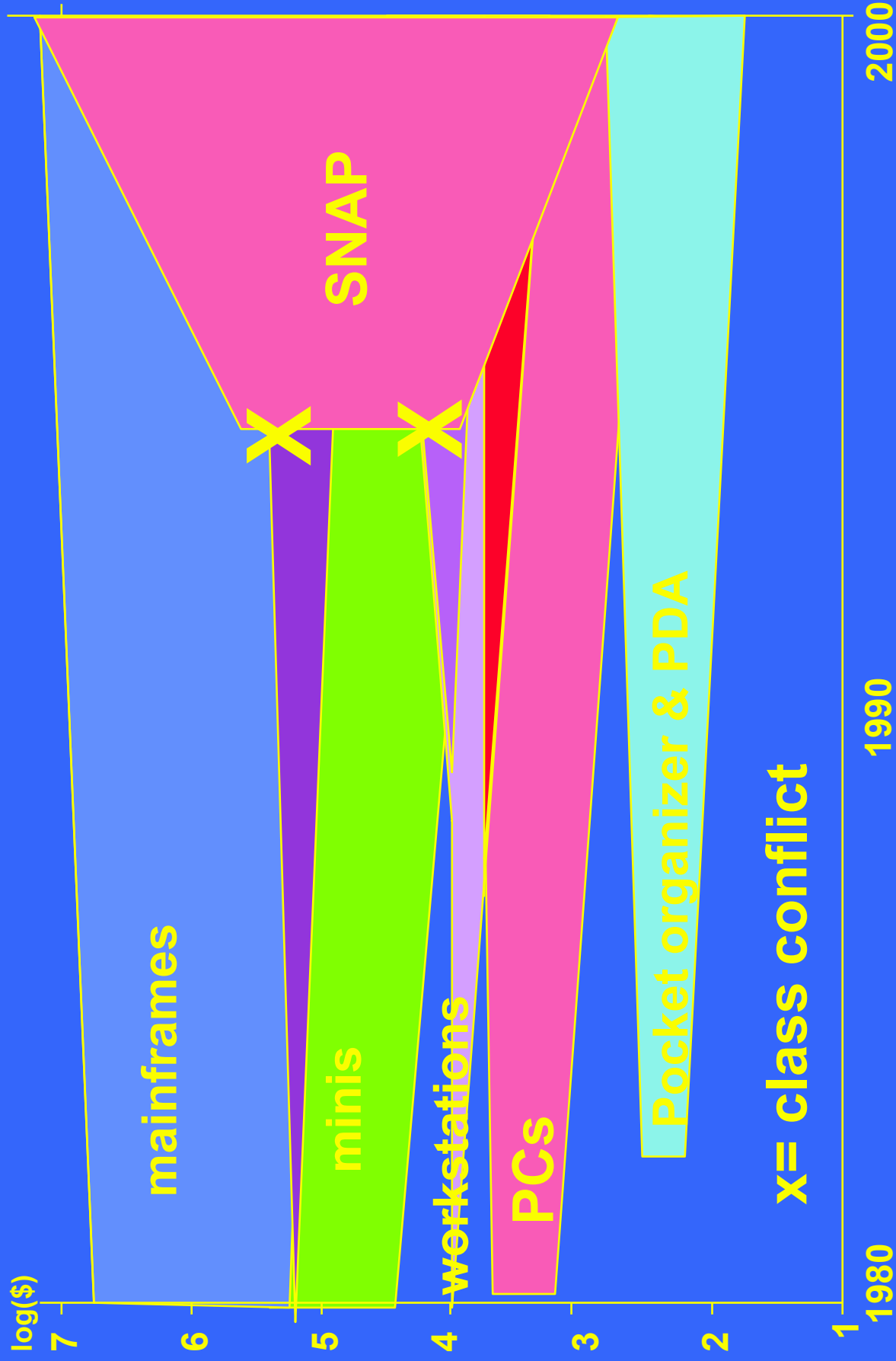

1990

2000

Copyright G Bell and J Gray 1996

Large servers... new services
are added “in flight”

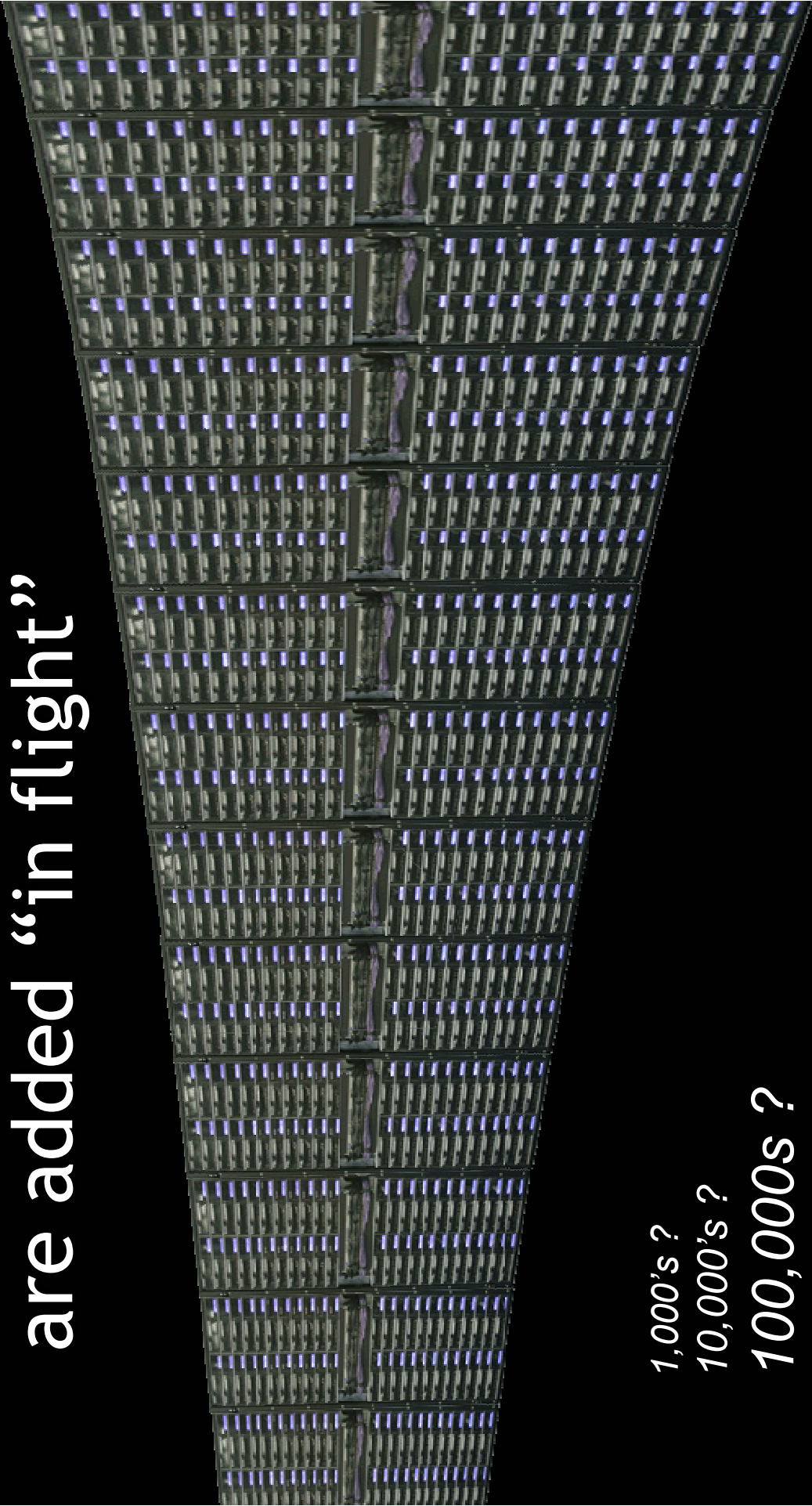

1,000's ?
10,000's ?
100,000s ?
1,000,000s ?

Bell's Law of Computer Classes

Hardware technology improvements i.e. Moore's Law for semis,... disks, enable two evolutionary paths(t) for computers:

- 1. constant price, increasing performance**
- 2. Constant or decreasing performance, decreasing cost by a factor $O(10)X$
.. leading to new structures or a new computer class!**

Bell's Law of Computer Classes

Technology enables two evolutionary paths:

1. constant performance, decreasing cost
2. constant price, increasing performance

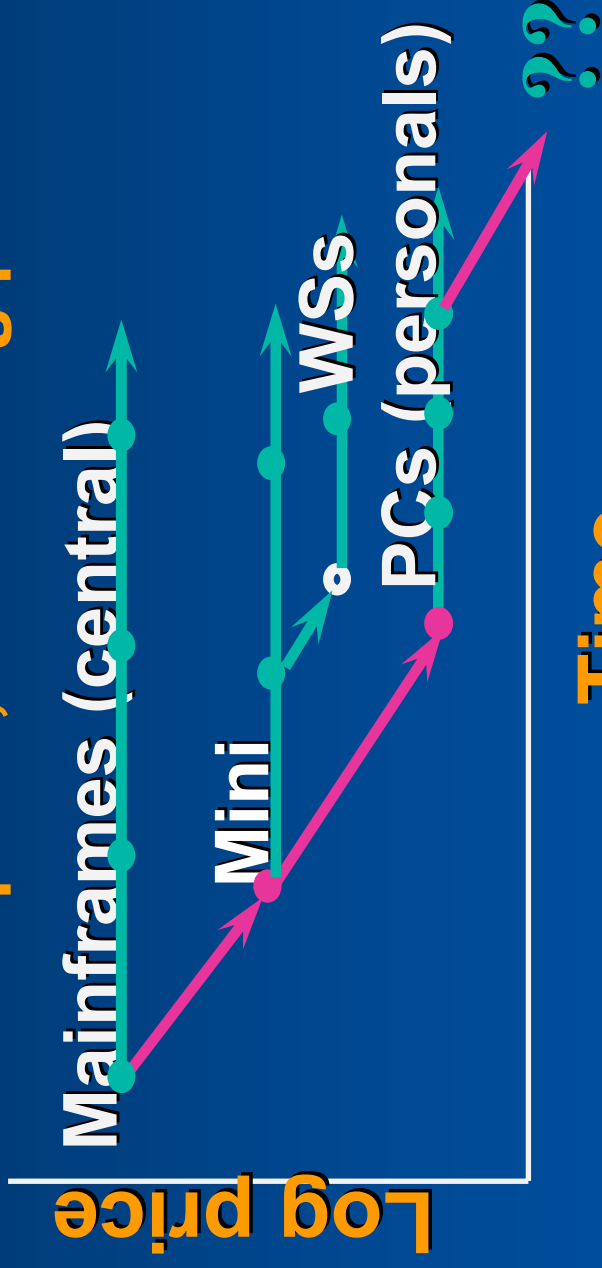

1.26 = $2x/3$ yrs -- 10x/decade; $1/1.26 = .8$

1.6 = $4x/3$ yrs --100x/decade; $1/1.6 = .62$

Conspiracies: Why old companies can't create new computer classes

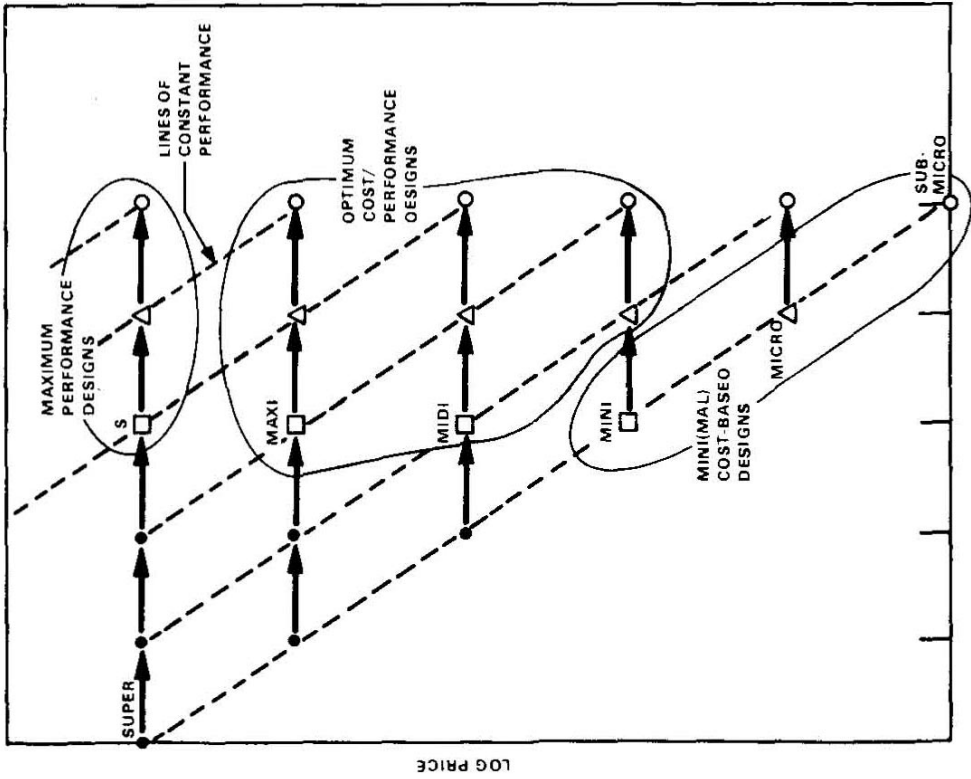

Introduction (generation)	Time			
	t	t + 1	t + 1	t + 1
Design style	Base case	Constant price/increased performance	Constant performance/decreased price	Constant performance/decreased price
Application	Base	Base	Base	New base
Computer price	1	1	0.5	0.5
Operating costs (range)	2-4	2-4	2-4	1-2
Total cost	3-5	3-5	2.5-4.5	1.5-2.5
Performance (and improvement)	1	2	1	1
Improvement (in total cost)	1	1	0.83-0.9	0.5
Performance/price (computer only and improvement)	1	2	2	2
Performance/total cost	0.33-0.2	0.66-0.4	0.4-0.22	0.66-0.4
Improvement (in performance/total cost)	1	2	1.21-1.1	2

t - 3 t - 2 t - 1 t t + 1 t + 2
 TIME →

Price, performance, and class of various goods & services

Computer price = \$10 x 10 class#

Computer weight = .05 x 10 class#

Car price = \$6K x 1.5 class #

Transportation artifact prices =
k x \$10 type (shoes,...cars,... trains,... ICBMs)

French Restaurants(t='95) =
f(ambiance, location) x \$25 x 1.5 stars

Platform, Interface, & Network Computer Class Enablers

“The Mini & PC/WS Web browser,
Computer” Timesharing

Platform
Mainframe

tube, core, SSI-MSI, disk, micro, floppy, PC, scalable
drum, tape, timeshare disk, bit-map servers,
batch O/S O/S display, mouse,
dist'd O/S

Interface
direct > terminals via
batch commands

WIMP Web, HTML

Network

POTS

LAN

Internet

Bell's Law of Computer Classes... Every Decade a new class emerges

•Every decade a new, lower (1/10) cost class of computers emerge to cover cyberspace with a

New computing platform

New Interface to humans or a part of physical world

New networking and/or interconnect structure

New classes --> new apps --> new industries

•The classes... a decade in price every decade

60s	\$millions	mainframes		
80s	\$10K	workstations & PCs;	<u>MICROS</u>	
70s	\$10K-100K	minis		
90s	\$1K	PCs		
00s	\$100s	PDA's & cellphones		
10s	\$10	SFF & CPSDs, sensors, motes		

Bell's Nine Computer Price Tiers

1\$:	embeddables e.g. greeting card
10\$:	wrist watch & wallet computers
100\$:	pocket/ palm computers
1,000\$:	portable computers
10,000\$:	personal computers (desktop)
100,000\$:	departmental computers (closet)
1,000,000\$:	site computers (glass house)
10,000,000\$:	regional computers (glass castle)
100,000,000\$:	national centers

Super server: costs more than \$100,000
“Mainframe”: costs more than \$1 million
an array of processors, disks, tapes, comm ports

The Vertical Dis-integration of the IT Industry: The Rise of Category Killers

Hierarchy of Value:

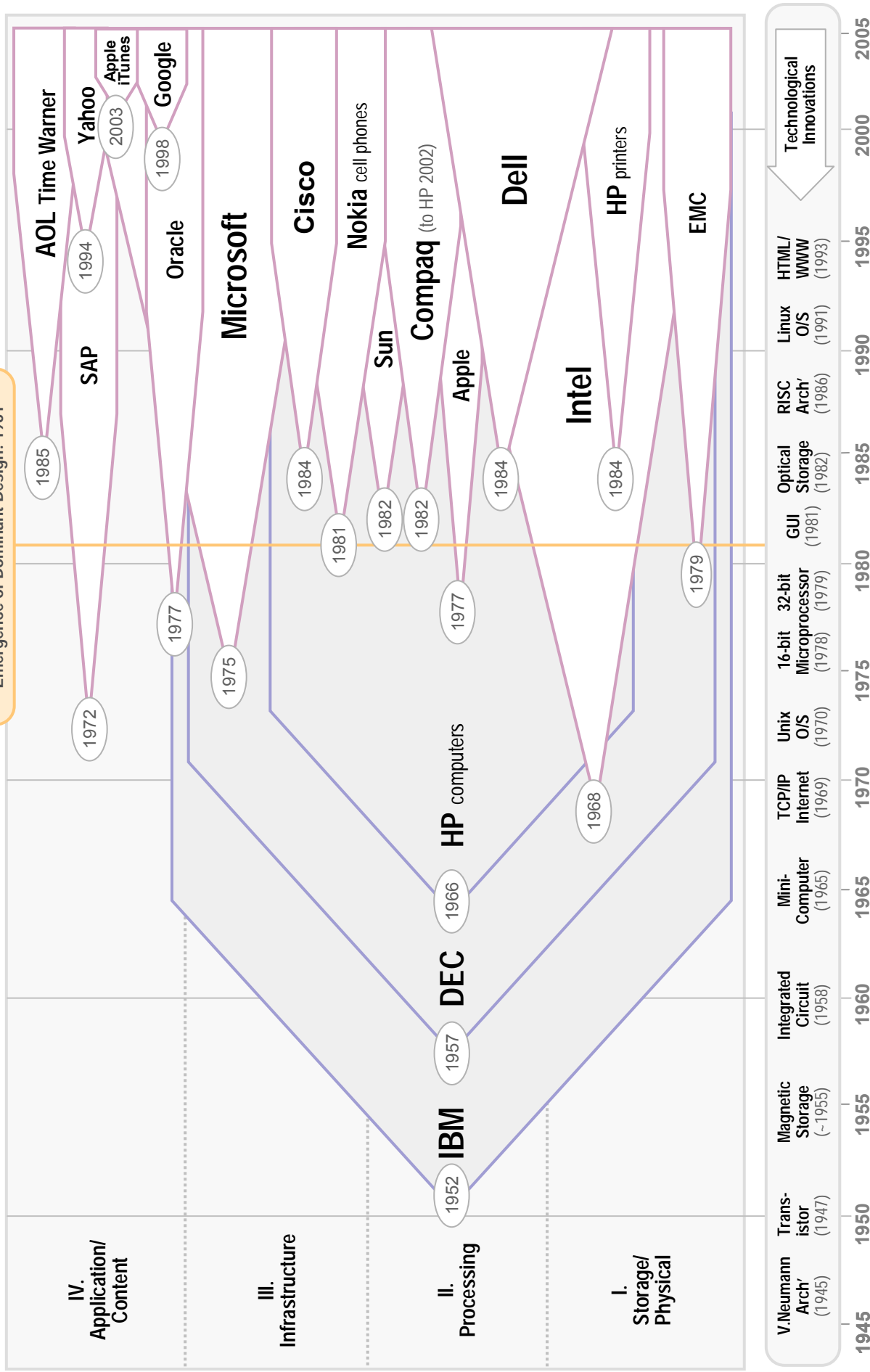

Provided Courtesy of Paul Kampas © All Rights Reserved

Pyramid of networked - computing, communicating, and storage devices

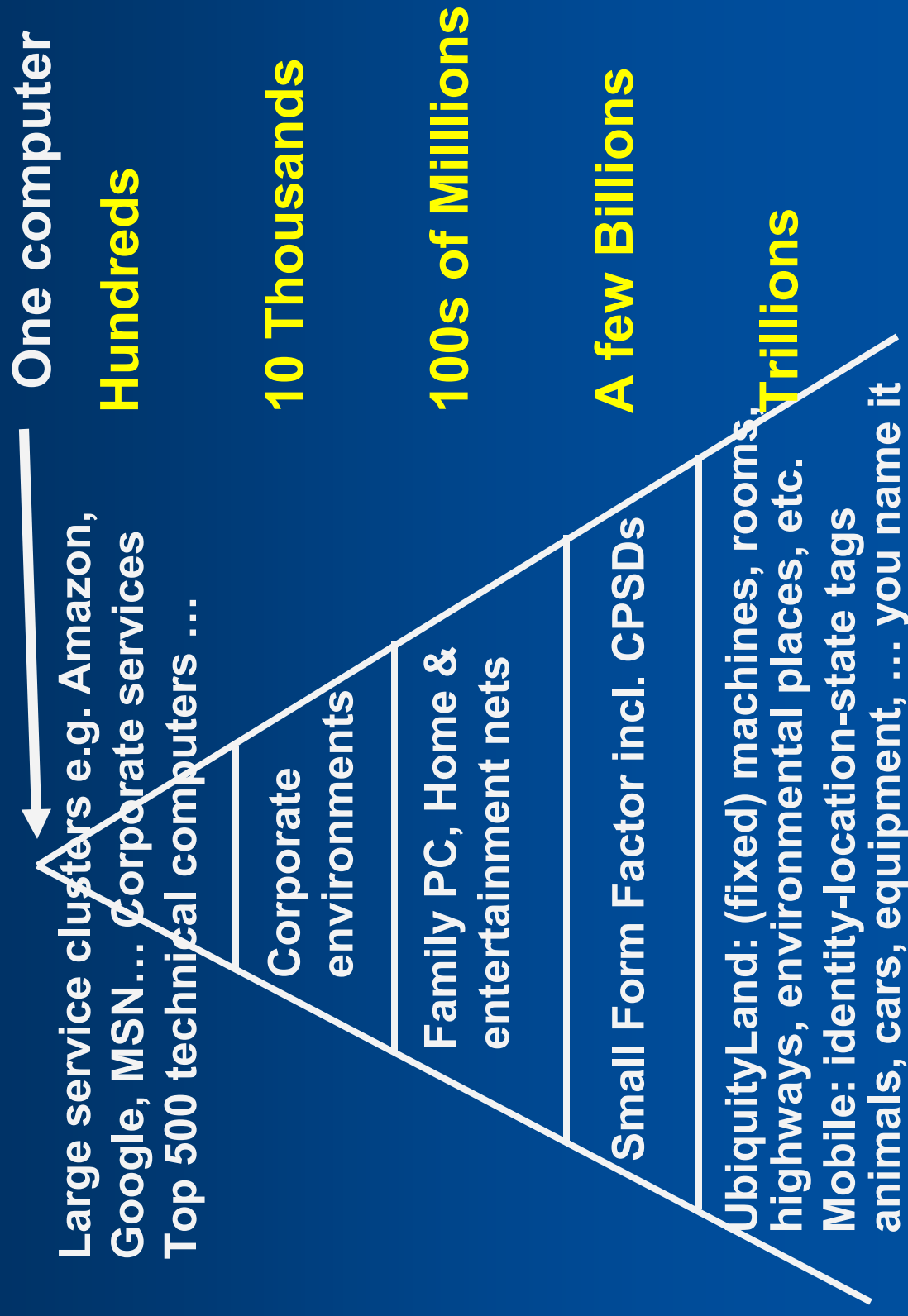

Computer Industry 1982

Solutions

Applications

OS

Computers

Processors

IBM

DEC

HP

NCR

Computing Laws

Law of Dis-integration: forming A Horizontal Computer Industry

- Horizontal integration is new structure
- Each layer picks best from lower layer
- All layers run //
- Desktop (C/S) market

- 1991: 50%
- 1995: 75%

Function	Example
Operation	AT&T
Integration	EDS
Applications	SAP
Middleware	Oracle
Baseware	Microsoft
Systems	Compaq
Silicon & Oxide	Intel & Seagate

Courtesy Andy Grove

Computing Laws

Structure of industry around DEC c1982

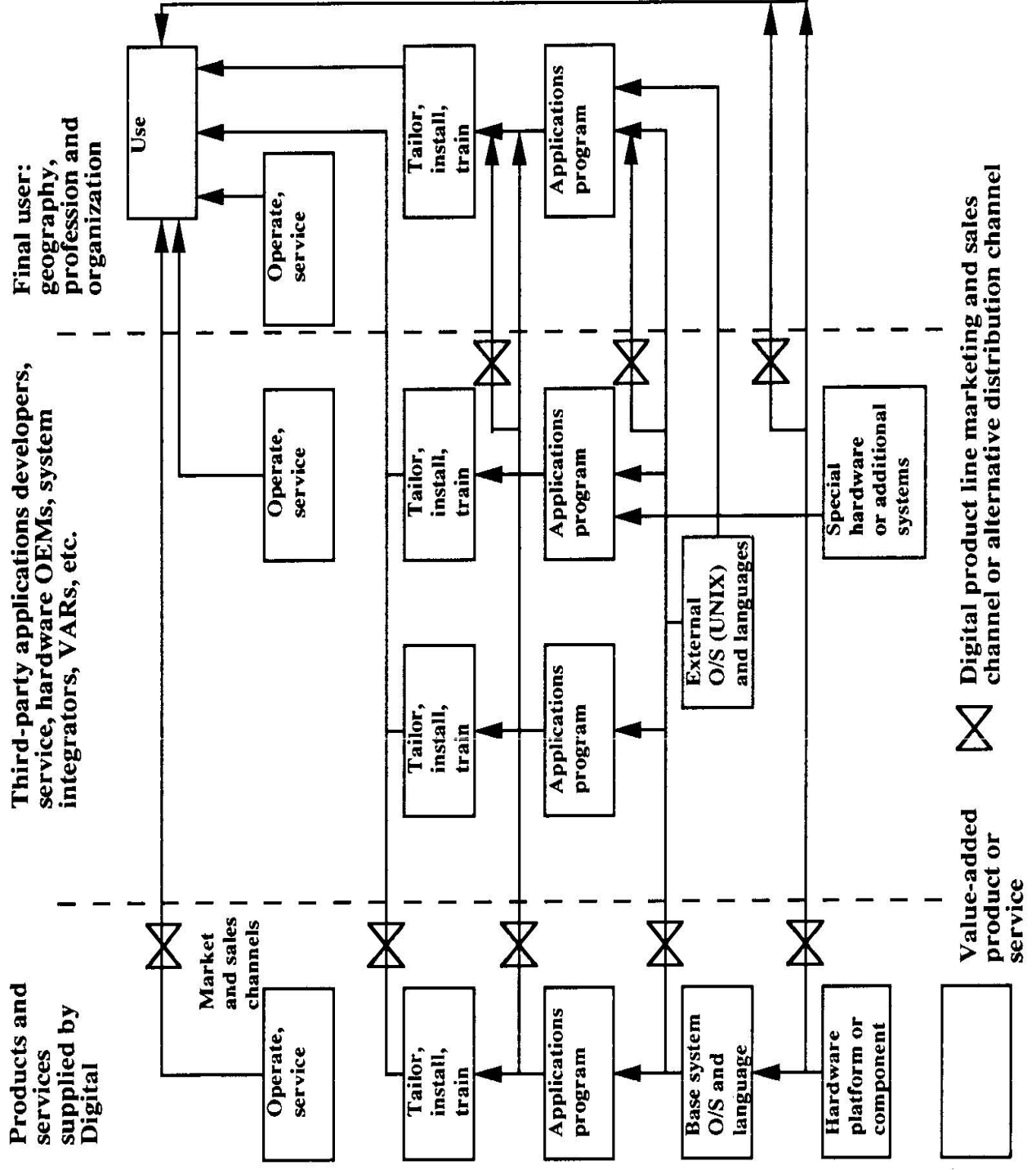

Bell's Law of Computer Classes & their Formation

End

Computing Laws

The 41 year life and trials of Digital Equipment Corp. aka DEC

- 1960: Birth of DEC from MIT Lincoln Lab... its evolution
- 1965-1984+?: Birth and death of the minicomputer industry
- **Theory: Bell's Law (of Computer Classes)**
- **1978: VAX and the VAX Strategy to become number 2**
- 1985-: PCs, workstations, “killer micros” and standards take on all comers
- **The DEC Organization and Culture... What happened?**
- **Summary...**

- Stories
 - PDP-1; ITT Store & Forward Switch... UART
 - PDP-6 from PDP-3. Compiler
 - PDP-5 how it was created & PDP-8
 - PDP-11 at CMU
 - VAX and VAX Strategy... address bit problem
 - Ethernet DIX, Liddle,

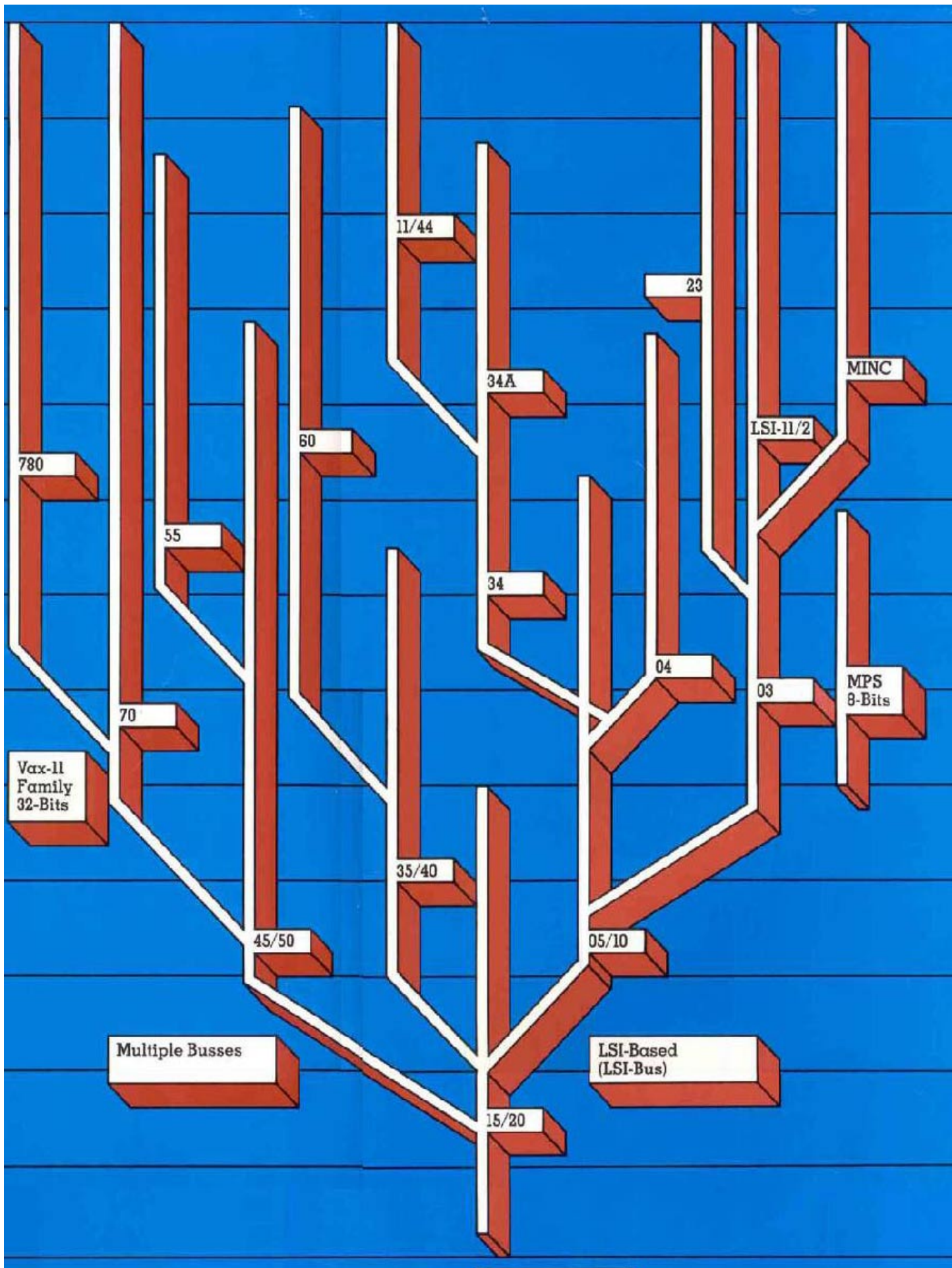

VAX-A Bluebook 1 April 1975

Bell, Cutler, Hastings, Lary, Rothman, Strecker

Had we the foresight, it was clear the pure, 16-bit 11 was born to have a short, happy, prolific, profitable life. In 1969, an address of 16-18 bits, and a system size being sold of 13-15 bits, left only 3 bits of address growth left. At the constant-price historical memory growth rates of 26 to 41 percent per year, only 6 to 9 years of comfortable lifetime is allowed, bringing it to 1975-1978.

“There is only one mistake that can be made in a computer design that is difficult to recover from – not providing enough address bits for memory addressing and memory management. The PDP-11 followed the unbroken tradition of nearly every known computer.

VAX Planning Model

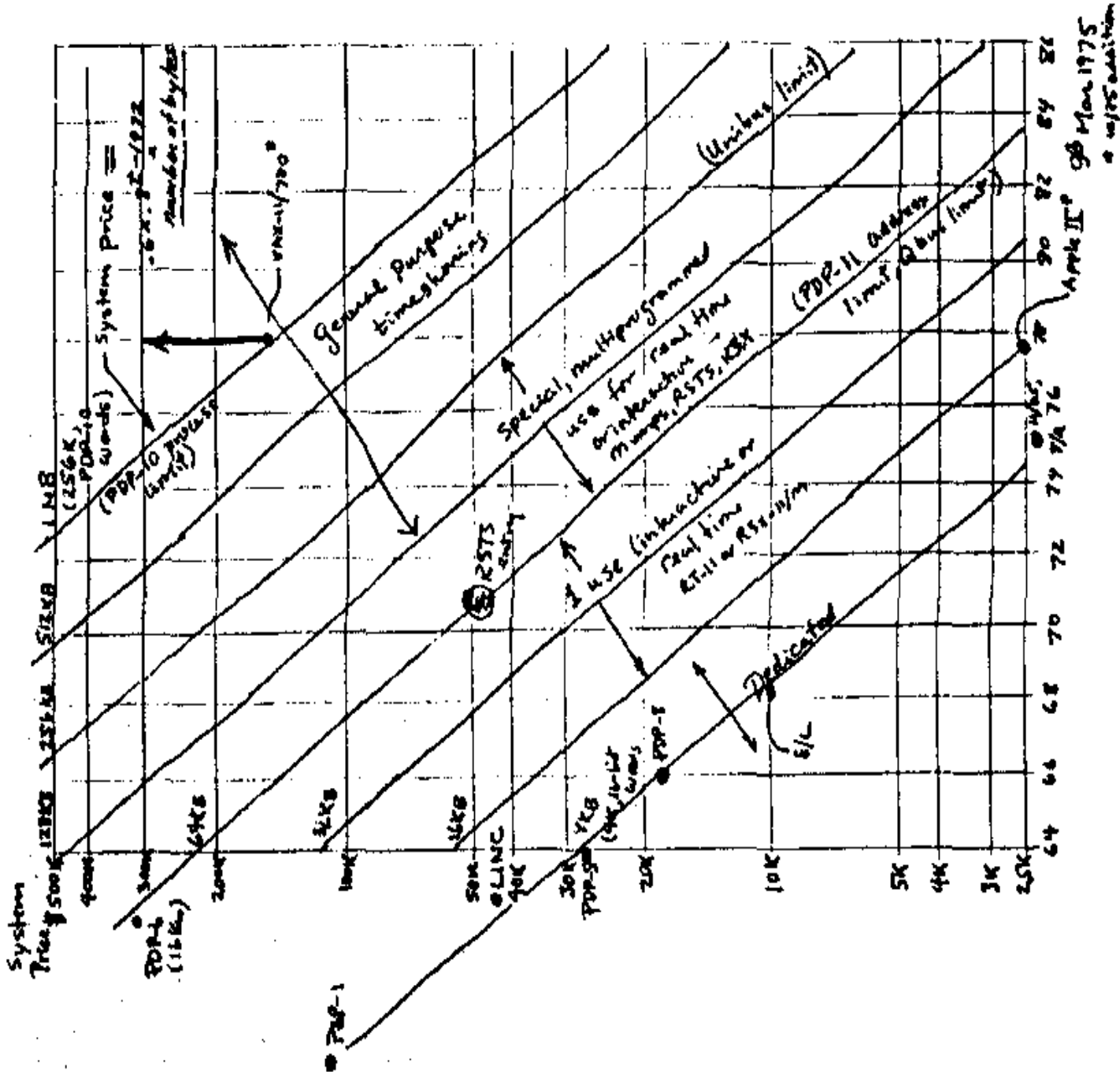

Gordon Bell's 1975 VAX Planning Model...

I Didn't Believe It!

System Price = 5 x 3 x .04 x memory size/ 1.26 (t-1972) K\$

- ◆ **5x: Memory is 20% of cost**
- ◆ **3x: DEC marku .04x: \$ per byte**
- ◆ **Didn't believe: the projection \$500 machine**
- ◆ **Couldn't comprehend implications**

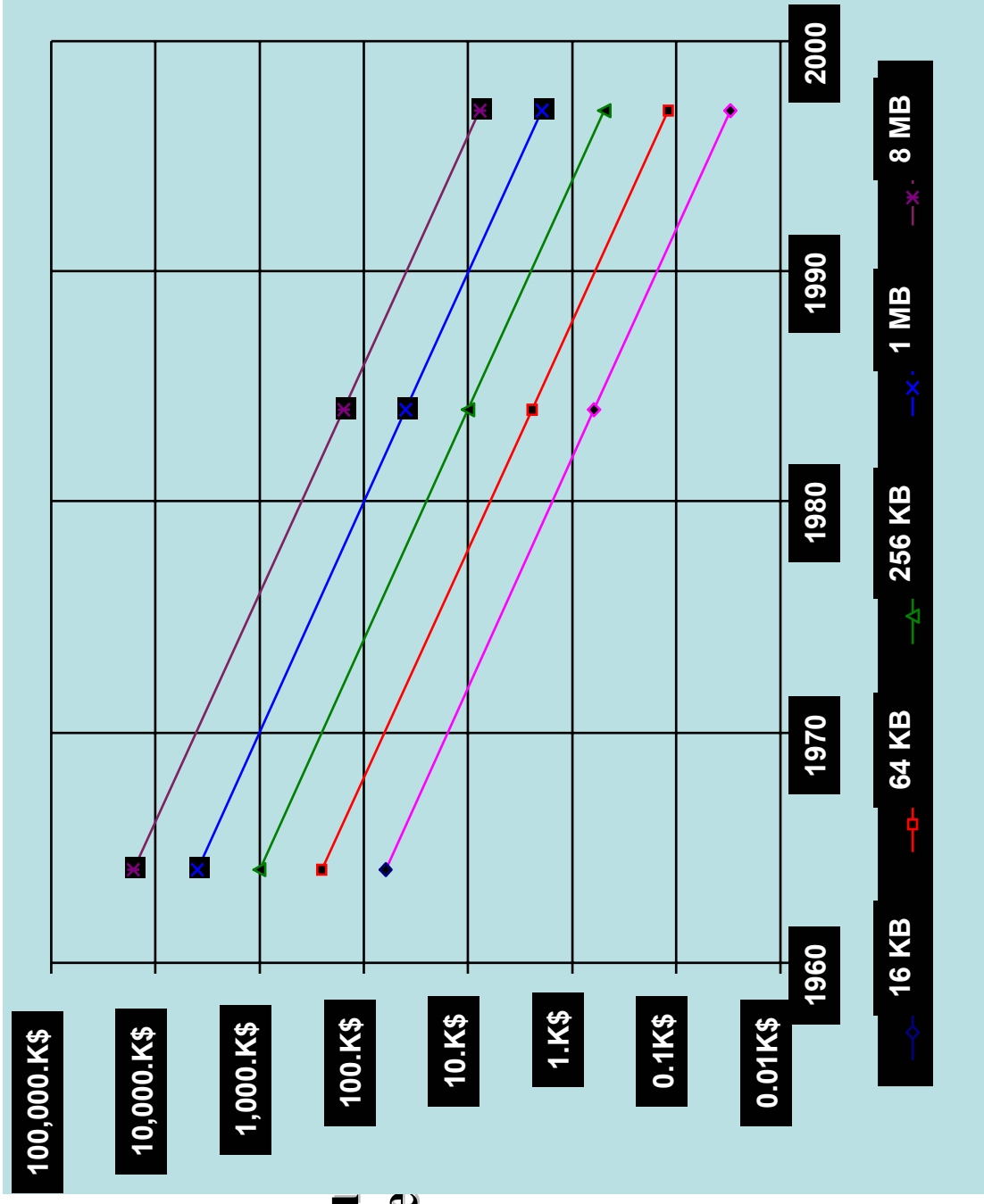

VAX/VMS Strategy (c1978)



- ...a homogeneous, distributed-computing system, where users interface, store information, & compute without reprogramming or extra work:
- via a **cluster of large computers using CI**,
- at local minis, workstations, & PC clusters,
- with interfaces to industry standard systems,
- interconnected via LANs (**Ethernet agreement was essential**), Campus Area, & WANs

DEC Value Migration

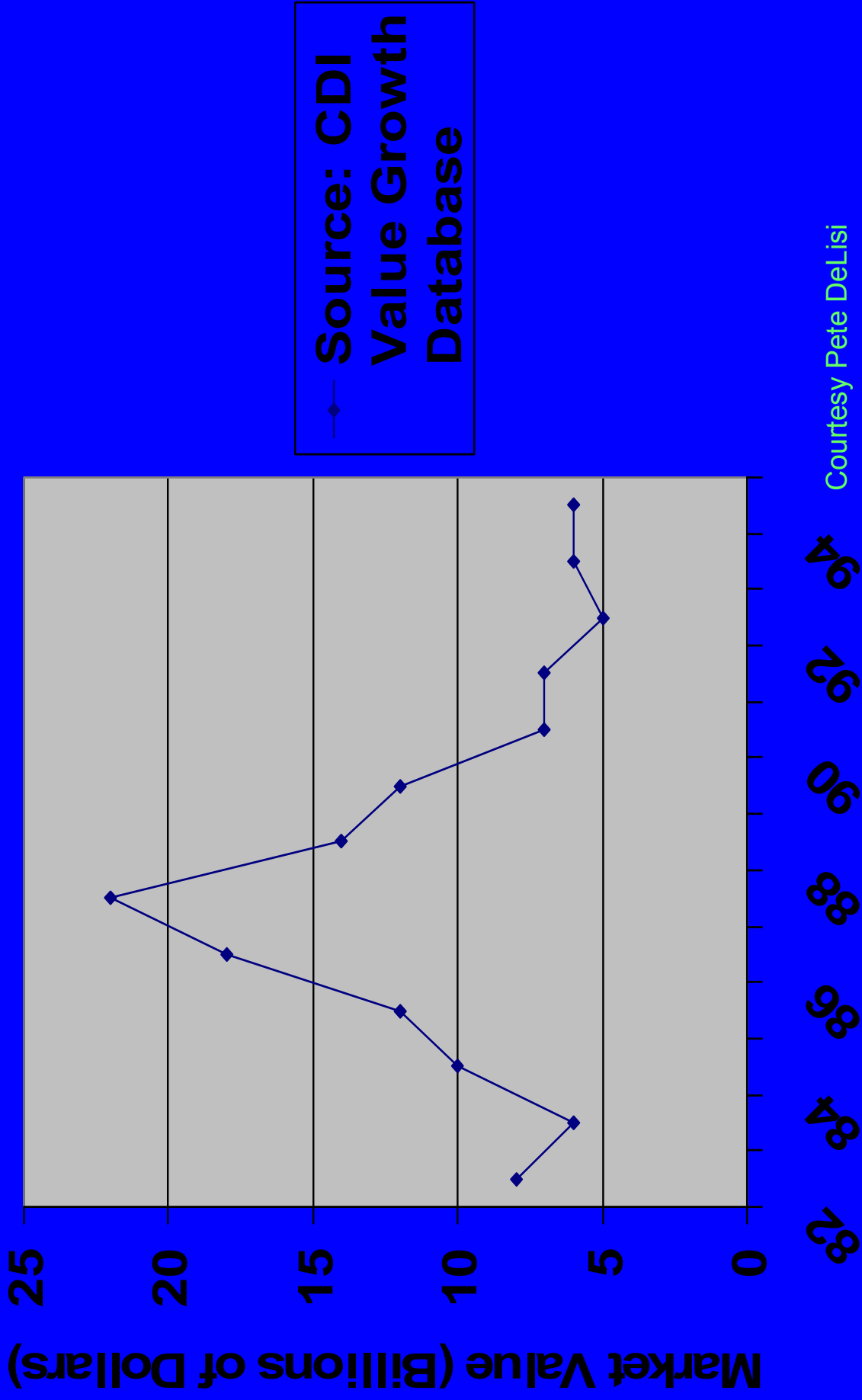

Source: CDI Value Growth Database

Courtesy Pete DeLisi

The 41 year life and trials of Digital Equipment Corp. aka DEC

- 1960: Birth of DEC from MIT Lincoln Lab... its evolution
- 1965-1984+?: Birth and death of the minicomputer industry
- **Theory: Bell's Law (of Computer Classes)**
- 1978: VAX and the VAX Strategy to become number 2
- **1985-: "killer micros" enable PCs, workstations, and standards to take on all comers**
- **The DEC Organization and Culture... What happened?**
- **Summary...**
- Stories
 - PDP-1; ITT Store & Forward Switch... UART
 - PDP-6 from PDP-3. Compiler
 - PDP-5 how it was created & PDP-8
 - PDP-11 at CMU
 - VAX and VAX Strategy... address bit problem
 - Ethernet DIX, Liddle,

Motorola 68K, UNIX License, PC Standard:

Anyone can manufacture computers

```
procedure Entrepreneur_Venture_Cycle
begin
  while Frustration > Reward {Push
    from Old_co} and
    Greed > Fear {Pull to New
      company} do
    begin
      get (PC, spreadsheet);
      IF System_Company then
        write (Beat_Vax_Plan);
      ELSE
        write (Plan)_
          New_Company
      get (Venture_capital);
      {from Old_Venture_Co}
      exit {job};
      start (New_Company);
    end
```

```
get (UNIX License, developers)
get (Vax, development_tools);
build (product); sell (product);
sell (New_Company);
  { @ 100 x sales }
venture_funds := Co_Sale
start (New_Venture_Co.);
end
```

Multis: Multiple, shared memory Microprocessors (Bell, Science 4/25/1985)

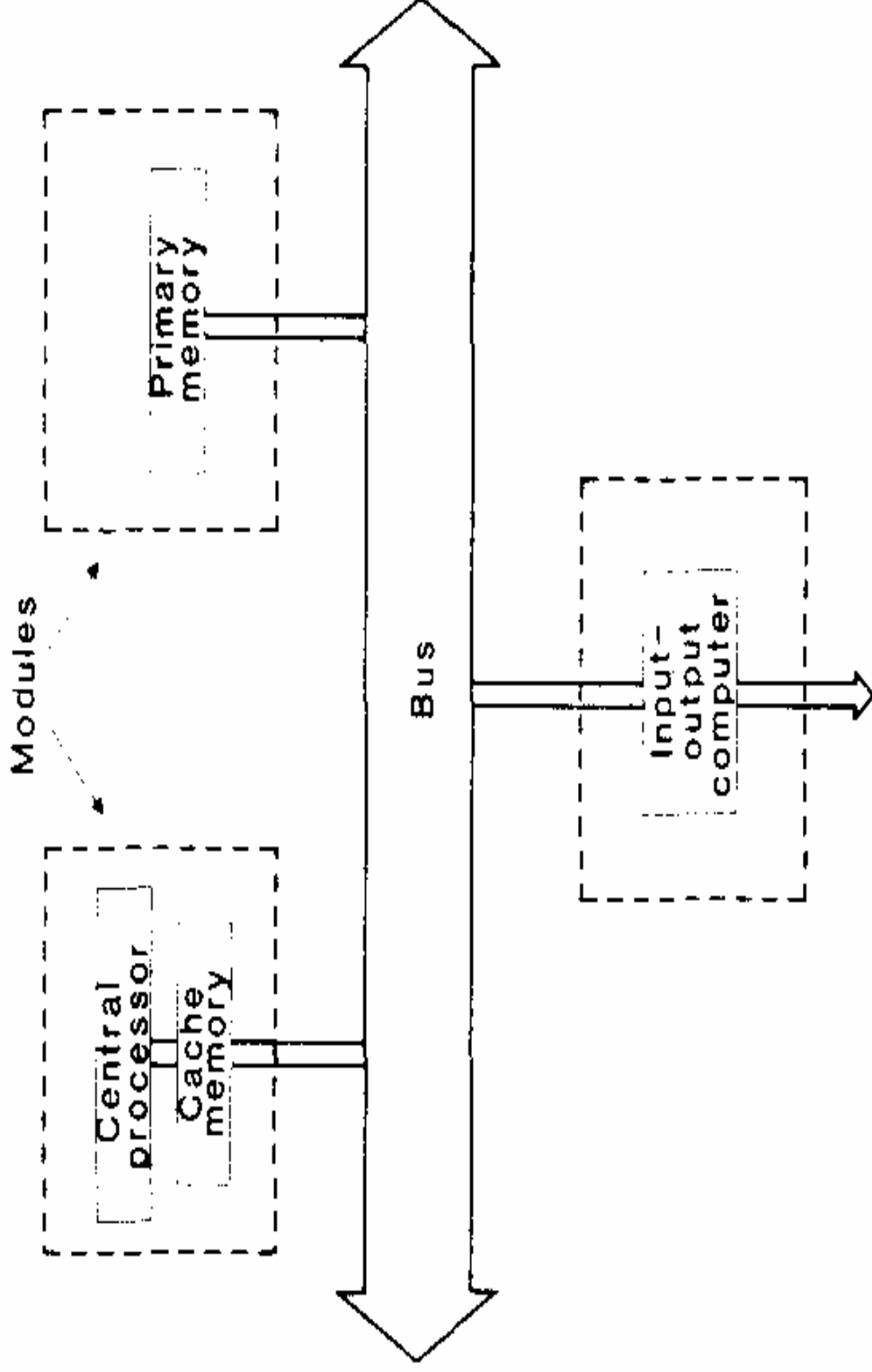

To disks, tapes, communications equipment,
local area networks, other buses

TTL & ECL to CMOS transition... Enter the "Killer Micro"!

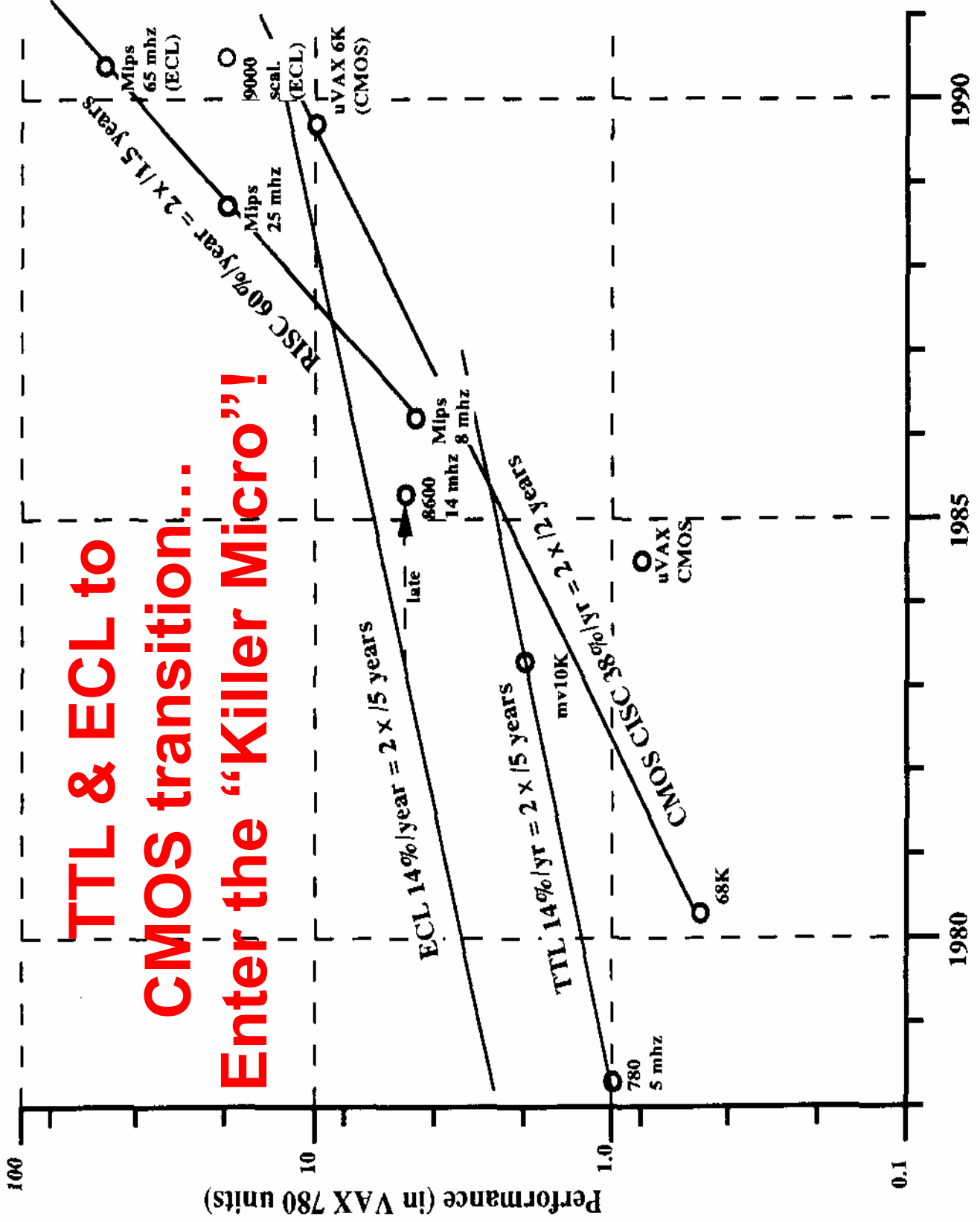

The Challenge: Dealing with technology *transitions* and any ensuing standards

Technology = Change = Disruption

- 1957: Vacuum tube to Transistor circuits (high bar)
- 1965: Transistors to ICs... 100 mini companies
- 1971: 8 bit Microprocessor >> master VLSI;
- 1981: IBM PC >> failure to embrace, only extend
- 1983: VLSI overtakes TTL AND ECL >> 9000 fail
- 1984+?+: UNIX and 32-bit micros >> standards fail
- “Either make the standard, or follow the standard.
If you fail to set the standard, you get to do it twice.”
- 1992: WWW Altavista, servers, clients. Mrkt'ng fail.

Digital's Trials by Technology...

With time, high tech becomes a commodity.

“DEC found guilty of violating Moore's Law ...” –gbell

1. Designing and building first transistor circuits. 1957-1965
2. Transition to integrated circuits & modulo 8 bits 1965-1975
3. Design with VLSI; *manufacturing VLSI* 1975-2002
4. Design of “clusters” as the ultimate computer 1983- ????
5. **Quadruple whammy c1983** – “killer” micros, UNIX: PC, Workstations, CMOS AND UNIX , as “standards”
Anyone can manufacturer computers in their dorm!
“You mean to say, our new ECL mainframe is not equal to our latest CMOS chip?” –Ken Olsen c1990
6. **Fail to exploit: networks, WWW, printers, clusters...**

Kampas' Pros & Cons products

- Leading 12, 16, 32-bit minis & OS's
 - Leading video terminals
 - Leading printing terminals (LA-xx), first desktop lasers
 - First www products
 - Leading OEM business
 - Leading office software
 - Effective divisional structure
 - MicroVAX II (M68000 + 8yrs)
 - VAX 8600 (8 years after 780)
 - VAX 9000 was unsuccessful >\$1B investment (1990)
 - RISC/Alpha (via MIPS; 6 years after Sun/HP)
 - Never fully endorsed Unix
 - Olsen: "snake oil"
 - Late to TCP/IP from OSI
 - Late to IBM-compatible PC
 - (Rainbow, Pro, DECmate)
 - Failed to divisionalize
 - Failed at low cost capability
- In the end: SEVEN Platforms VAX, X86, MIPS and Unices**

The Rise and Fall of DEC: Annotated Timeline

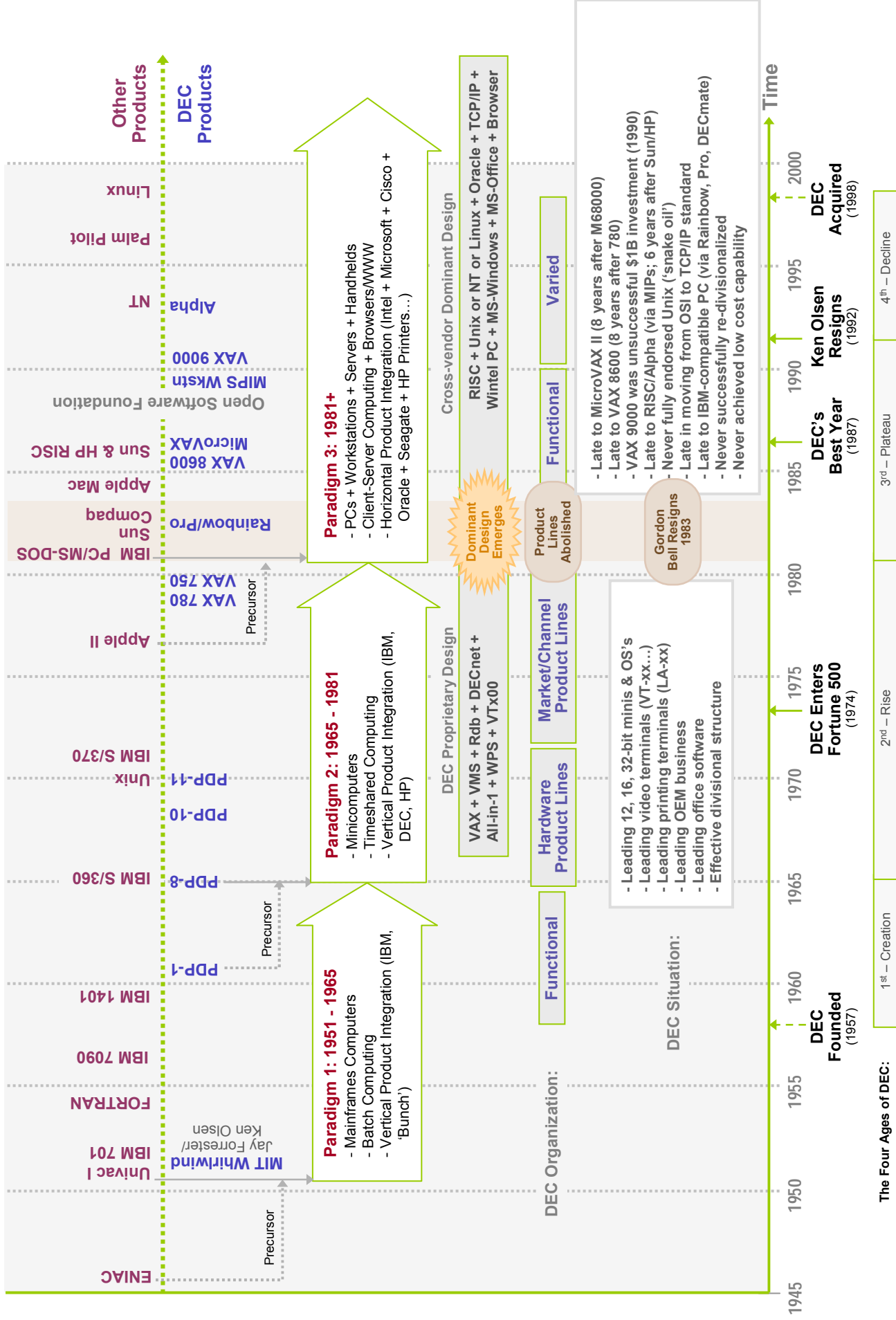

The 41 year life and trials of Digital Equipment Corp. aka DEC

- 1960: Birth of DEC from MIT Lincoln Lab... its evolution
- 1965-1984+?: Birth and death of the minicomputer industry
- **Theory: Bell's Law (of Computer Classes)**
- 1978: VAX and the VAX Strategy to become number 2
- 1985-: PCs, workstations, “killer micros” and standards take on all comers
- **The DEC Organization and Culture... What happened?**
- **Summary...**
- Stories
 - PDP-1; ITT Store & Forward Switch... UART
 - PDP-6 from PDP-3. Compiler
 - PDP-5 how it was created & PDP-8
 - PDP-11 at CMU
 - VAX and VAX Strategy... address bit problem
 - Ethernet DIX, Liddle,

Cross-sectional View of the DEC Organizational System c.1970s: "The DEC Way"

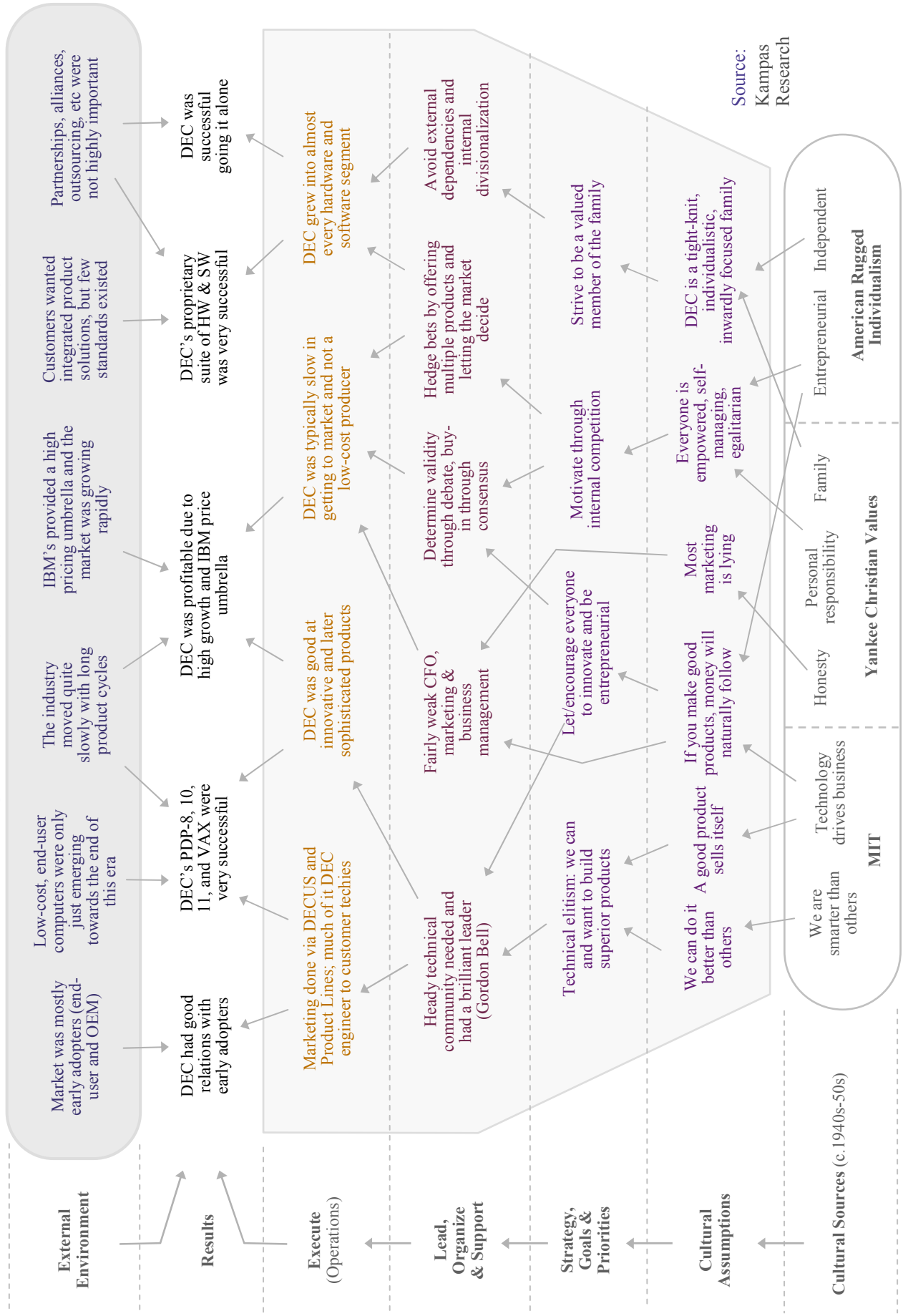

What Does a Technology Company Look Like? (A look at Microsoft and Digital aka DEC)

Gordon Bell

Perspective from the depths of
Microsoft Research

Three part comparison with MSFT

- Observations on high tech organization cultures based on my experience at Digital aka DEC, Microsoft, and various high tech startups
 - Is it scalable?
 - Built productively on appropriate technology?

Microsoft Secrets

Cusumano and Selby

1. Organizing and managing the company
 - Find smart people who know technology & business
 - Hiring pool, interviews, turn-over...
2. Managing creative people and technical skills
 - Small teams, overlapping functional specialists
3. Compete with products and standards *NOT brand Bodies!*
 - Pioneer and orchestrate mass markets... try many
4. Defining products and development processes
 - Focus creativity on evolution and fixing resources
5. Develop and ship products
 - Do it in parallel, synchronize and stabilize
6. Build a learning organization
 - Improve through continuous self-critiquing, feedback, and sharing
7. Attack the future... be or be in, the mainstream... home, games, SAAS/SAS (SW as Services).

Microsoft

- Product and process. Architecture for // development
- HBR Article: Architecture, interfaces, int/ext developers
 - Growing, increasingly valuable platform
- Small teams, interconnect with sync
- One development site w/ research. Large capital expenditures.
- Common language. Common development environment.
...whole company tests (we eat our own dog food)
- No single point of developer failure
- Managers who create technology, make technical decisions
- Quick decision making re. business etc. issues
- Feedback from users...e.g. *Do you want to send this to MS?*
- Learn from the past... v3 is great
- *Try things, don't give up...* be prepared to fail vod, webtv, ...
- *An understanding and appreciation for the individual... stock*
- Research!

DEC Cultural Beliefs (Ed Schein ms.) unconscious, shared, tacit assumptions

1. “Rational & Active Problem Solving”
2. Giving People Freedom Will Make Them Responsible
3. Responsibility means Being on Top of One’s Job, and owning one’s own Problems. (He who plans, does.)
4. “Truth through Conflict” and “Buy-In”
5. Internal Competition and “Let the Market Decide”
6. Management by Passion, but Work should be Fun and Enjoyable. Benign Manipulation or Controlled Chaos
7. Perpetual Learning
8. Loyalty and Life Time Employment
9. *Moral commitment to customers*

Digital according to Schein

- Individualism
- Truth through conflict
- Personal responsibility
- Engineering arrogance
- Market competition...let it decide
- Paternalistic commitment to people
- Organizational idealism
- Moral commitment to customers

Digital-gb 1

- Great responsibility, freedom, and trust in the individual.
 - **“Do the right thing.” Open door-email.**
 - ***Scalability is a problem.***
 - **Paternalistic organization.**
- “He who proposes, does.” Very little was top-down
 - **Product managers are part of the product (conflict at low level)**
 - **Small, responsible teams. Make their own schedules.**
 - **CDC: Cray left, machines obsolete, ETA had no legacy, Price (CEO) thought top decides, bottom executes**
- Conflict is good. Came from starting from M.I.T. Data decides
- OK to have competing and overlapping technology/projects/products, *but know when to cut them! When DEC started down, it had almost 10 platforms*

Digital gb-2

- **Focus on Customer. Let them decide the strategy.**
- **Profit is essential ...all products were measured**
- **“Either make the standard or follow it, if you fail to make the standard you get to do it twice.” IBM PC versus 3**
- **“Make what you can sell, not what you can buy.”
Therefore: sell everything you make.” semi**
- **Wilkes: “Stay in the mainstream” ... SOS, ECL**
- **Beware of complex structures. Buyer-seller relationships versus matrix**

DEC: Schein View of What's Learned

- “1. Don't judge a company by its public face.
2. A culture of innovation does not scale up; “functional familiarity” and “truth through debate” are lost with size; “do the right thing” becomes dysfunctional; managerial sense of responsibility changes with age and maturity; buy-in becomes superficial agreement.
3. If a culture of innovation only works at a certain small size, the organization must either find a way to break away small units that continue to innovate or abandon innovation as a strategic priority.
4. A culture that breeds success and growth over a considerable time becomes stable and embedded even if it contains dysfunctional elements; changing the culture means changing key people who are the culture carriers
5. Cultures are sometimes stronger than organizations
6. A successful technical vision will eventually create its own competition and, therefore, changes in technology and in the market conditions; dominant designs will emerge and commoditization will occur.
7. Successful growth based on a technical vision will hide business problems and inefficiencies until an economic crisis reveals them or until the business gene is switched on; recognition of those problems will not necessarily produce remedial action.
8. If a growing business lacks the business gene, the Board must act to introduce that gene.
9. If you try to do everything, you may end up not doing anything very well.
10. How the market evolves may not reflect either the best technology or the most obvious logic.
11. A technical vision that is right for its time can blind you to technical evolution
12. The value of “listening to your customers” depends upon which customers you choose to listen to.
13. The type of Governance System an organization uses must evolve as the organization matures
14. The events and forces act in unison”

A Puzzling Question

What would cause one of the industrial stars of the 20th century, and one of the first truly digital economy companies, at the very zenith of its success, to begin a precipitous decline that would eventually result in its demise?

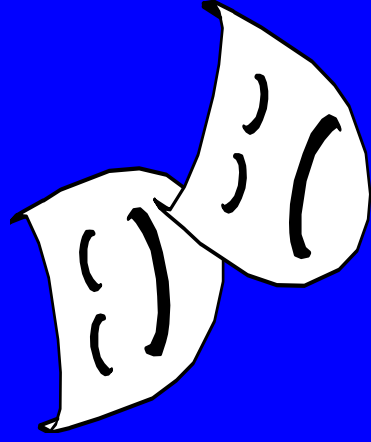

Courtesy Pete DeLisi

Why did Digital fail (GB)

- **The top 3-5 execs didn't understand computing**
 - Moore's Law, Standards and their effect
 - Platforms and their support
 - Levels of integration, make-buy, and ISVs
 - Competitor metrics: it simply got "out of control"
- Destroyed its marketing organization, requiring a complex matrixed organization, but lacking ISVs
- Didn't exploit: printing (e.g. HP), networking (e.g. Cisco), the Web, and UNIX
- Did: ECL mainframe, non-compatible PC, too many platforms, semi-fabs without partnerships

Manufacturing has never been DEC's strength as a high overhead, bureaucratic, slow-moving, conservative old boy network organization. It is slow to get products to the marketplace with a low degree of automation. Cost reduction consists of going overseas to low cost producers to buy out from Tandy. DEC will be unable to compete with Japanese producers in the future years. It had a strong Taiwan group.

Products overall are not bad. Communication is DEC's strongest position. The CMOS VAX micros have saved DEC. DEC should have made a very large multiprocessor with 20-50 microprocessor for transaction processing that would have betat IBM, Tandem, etc. and kept higher selling price and margins. The ECL 9000 is not especially cost-competitive as a mainframe. Unlike HP, DEC failed to respond to the PC as a standard that sits on every desk. The product flaw is there are TOO MANY!

Engineering and technology have been DEC's past strengths, especially in architecture, networking, software, semiconductor and large disks. The ECL 9000 took too many resources, robbing the company of potential gains elsewhere. DEC spends more on R&D than any other mfg. outside of IBM. Engineering failed to build a competitive workstation or PC, hence is disproportionately higher than it should be. Strength in terminals and low cost systems were not used to get competitive products in the PC and small server product space. DEC missed key products, technologies, and cost-reductions.

Control seems very poor... namely the company seems unable to do what it says it's going to do. The greatest source of poor control is in productivity, when it started buying more from outside and failed to downsize.

Financeability will not continue without improvements in all the key dimensions, together with a vision for the company of how it is to respond to the key exogenous pressures: demand for commodity standards which put enormous pressure on the expense lines; lower cost systems that yield exceptional price per MIPS and do the work of yesterday's systems that cost 10X the price. DEC has to position itself so as to not look like a losing mini company such as DG, HP, WANG, Prime or a traditional mainframe company such as Unisys, CDC, Bull.

DEC missed 3 major market segments: PCs, Workstations, and minisupers, all of which ate into minis. It missed RISC as a technology. Betting on the company in the 1990s is unwise given the overall situation in the market and in all other dimensions.

Every customer, employee, and stockholder is concerned with DEC's strategy or Vision. Is it simply: we provide every possible platform, you choose and find the Application software?

Business Plan & Vision

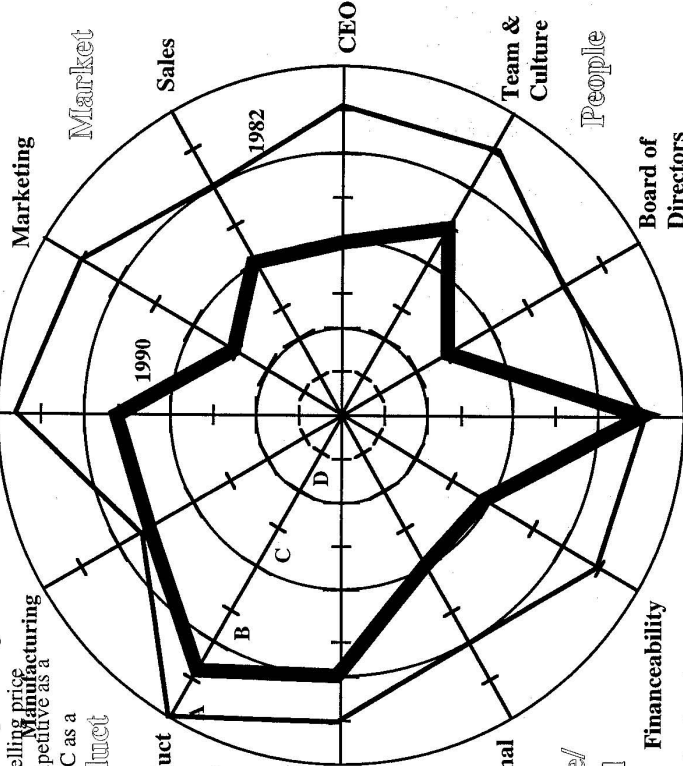

Marketing is the number two problem. It has completely lost the communication between customer application segments (e.g. ECAD, insurance office, semiconductor manufacturer) and the product planning. As such it has no way to decide what to get for applications software or what platforms to recommend. The vast array of products with no market means the customer has to decide.

Sales is led by a non-salesman, such an organization is flawed. Until DEC puts the field organization on a commission plan where the salesmen are really forced to produce, the sales folks will probably spend more time concerned about politics than customers and selling. Distribution of computing is moving from the 100K salesman. to the retail level.

KHO is clearly a legend. Recent performance is poor and he has no suitable successor. He now shares the CEO slot with someone with less stature. It is ironic that someone who failed in products and controlling manufacturing cost is COO. His failure is simply not being the CEO and seeing to it that he has a quality team and organization.

Is the top level team fundamentally weak without a representation of the marketing, sales, and a disconnect of the product builders? In the early 1980s, the Operations Committee was extremely strong. The problem then was that the team was not led by KHO to resolve and find a product direction that would be successful in personal computing. The result, IBM walked away with it.... Compaq formed, etc. Similar stories can be told about worstations, minisupers, and RISC.

The Board is considerably weaker with the loss of General. Doriot who is probably the only person that Ken could talk with or listen to. Everett is the only board member who has an understanding of computers. Although the board members are ok, and have been connected, all are retired and are not in touch with the issues of the 1980s vis a vis computation. The average PC user (a few 10 millions of them) is in better touch with computing than the board, top level team, and the CEO.

Cash (\$, ¥)
DEC has a healthy cash position, but this will evaporate quickly with loss. The question is what is the true balance sheet of the company, given that an appreciable amount is in real estate and factory?

Board of Directors
The Board is considerably weaker with the loss of General. Doriot who is probably the only person that Ken could talk with or listen to. Everett is the only board member who has an understanding of computers. Although the board members are ok, and have been connected, all are retired and are not in touch with the issues of the 1980s vis a vis computation. The average PC user (a few 10 millions of them) is in better touch with computing than the board, top level team, and the CEO.

Bell-Mason Diagnostic Relational Graph With A Plot of Gordon Bell's Evaluation of Digital Equipment Corp. 11/90

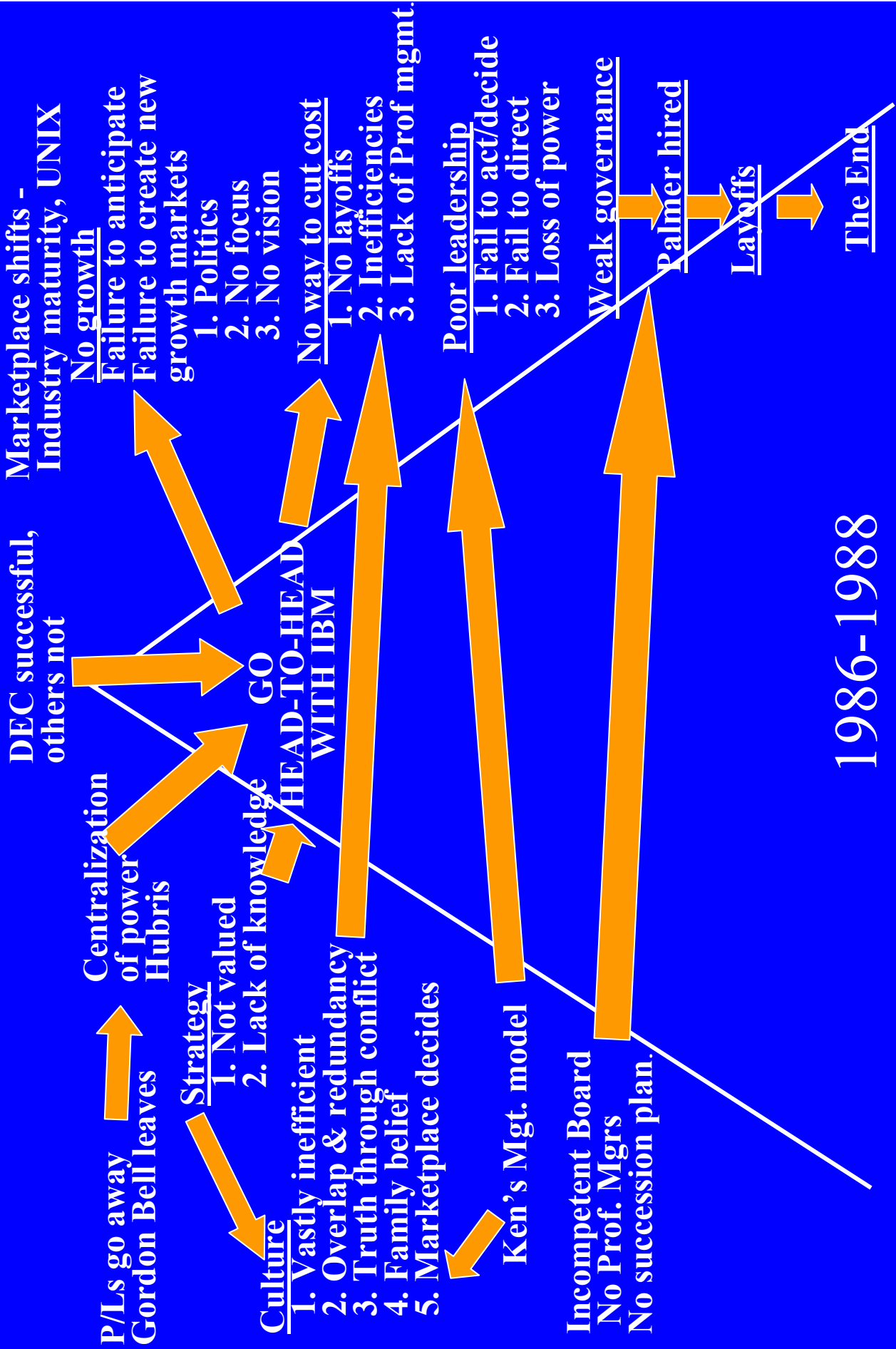

Courtesy Pete DeLisi

Digital's Trials by Technology...

With time, high tech becomes a commodity.

“DEC found guilty of violating Moore's Law ...” –gbell

1. Designing and building first transistor circuits. 1957-1965
2. Transition to integrated circuits & modulo 8 bits 1965-1975
3. Design with VLSI; *manufacturing VLSI* 1975-2002
4. Design of “clusters” as the ultimate computer 1983- ????
5. **Quadruple whammy c1983** – “killer” micros, UNIX: PC, Workstations, CMOS AND UNIX , as “standards”
Anyone can manufacturer computers in their dorm!
“You mean to say, our new ECL mainframe is not equal to our latest CMOS chip?” –Ken Olsen c1990
6. **Fail to exploit: networks, WWW, printers, clusters...**

Paul Kampas' View of the Computer Industry and DEC Failure

The Vertical Dis-integration of the IT Industry: The Rise of Category Killers

Hierarchy of Value:

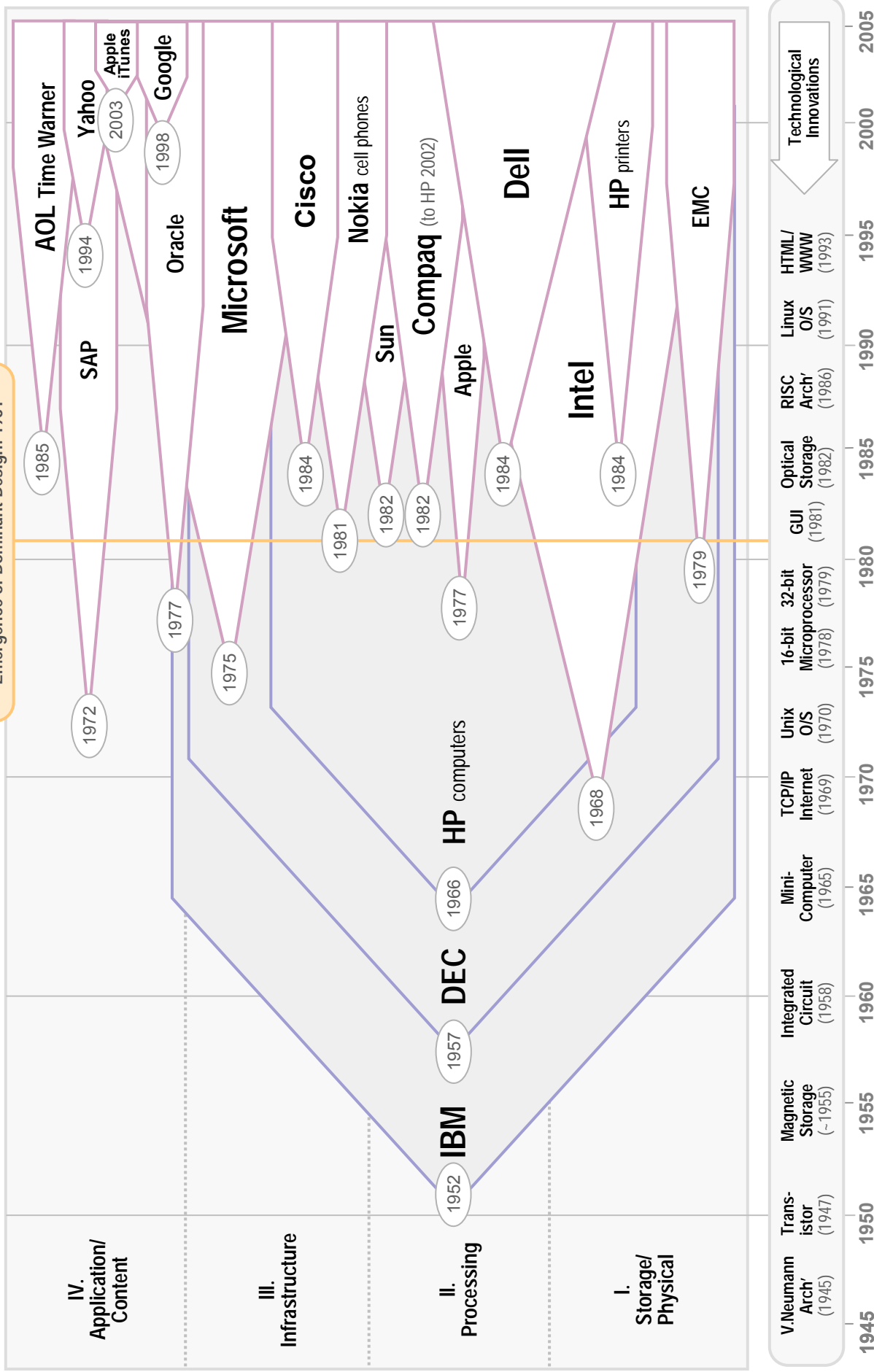

Provided Courtesy of Paul Kampas © All Rights Reserved

The Rise and Fall of DEC: Annotated Timeline

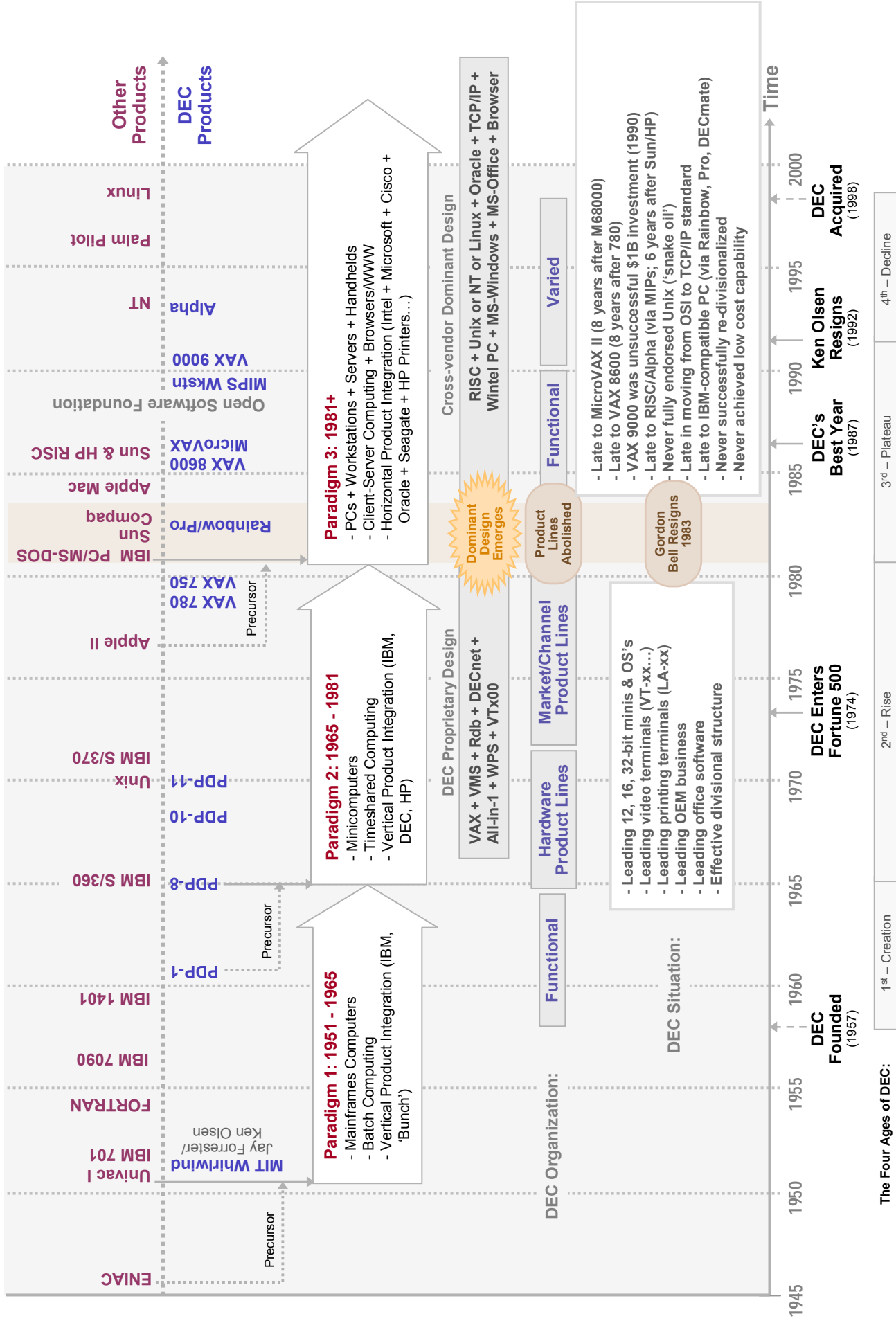

Cross-sectional View of the DEC Organizational System c.1970s: "The DEC Way"

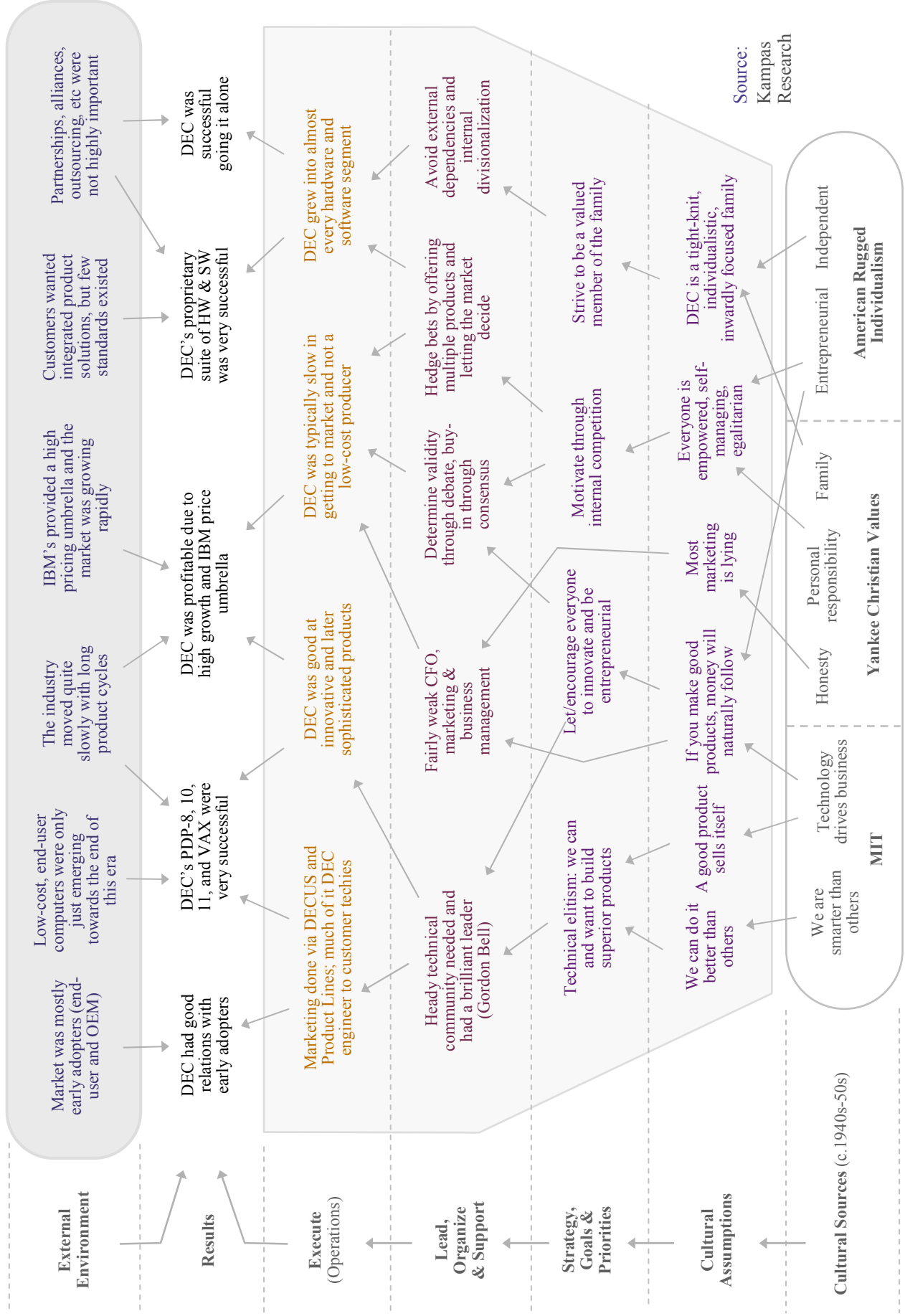

DEC's Position in the Evolving Computer Industry Landscape: 1976 - 2001

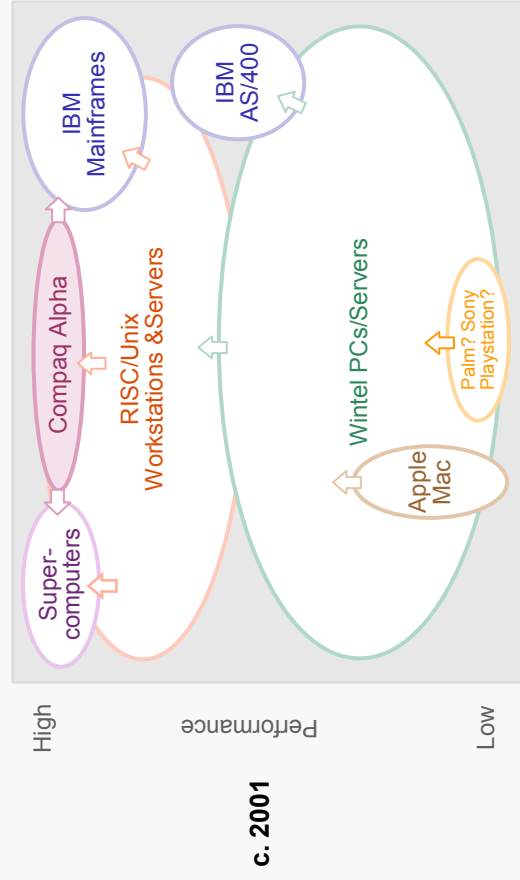
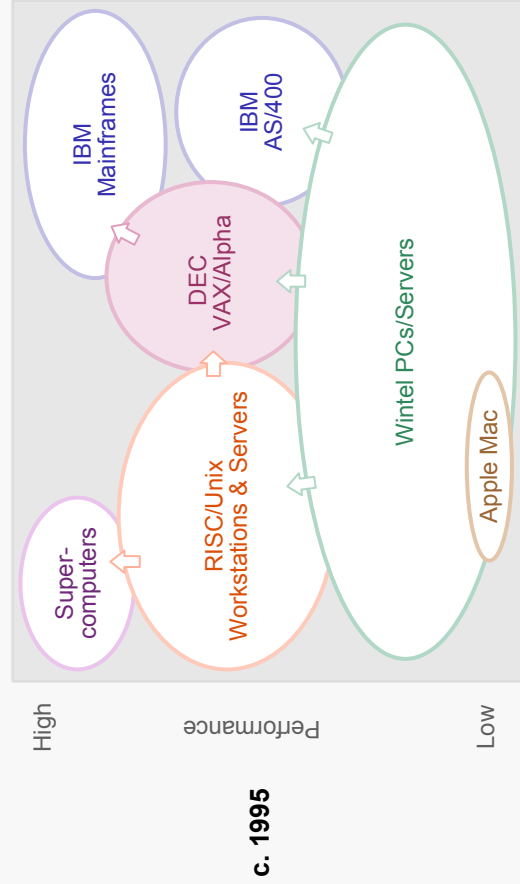
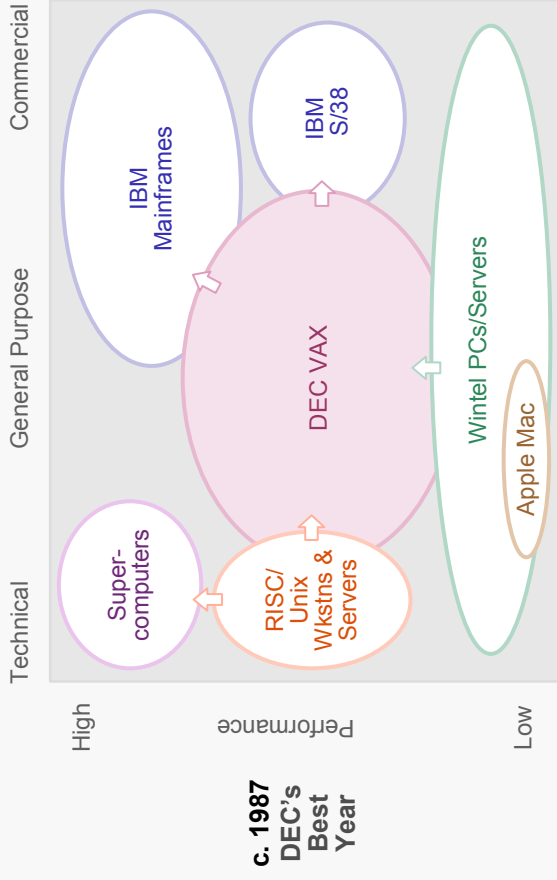
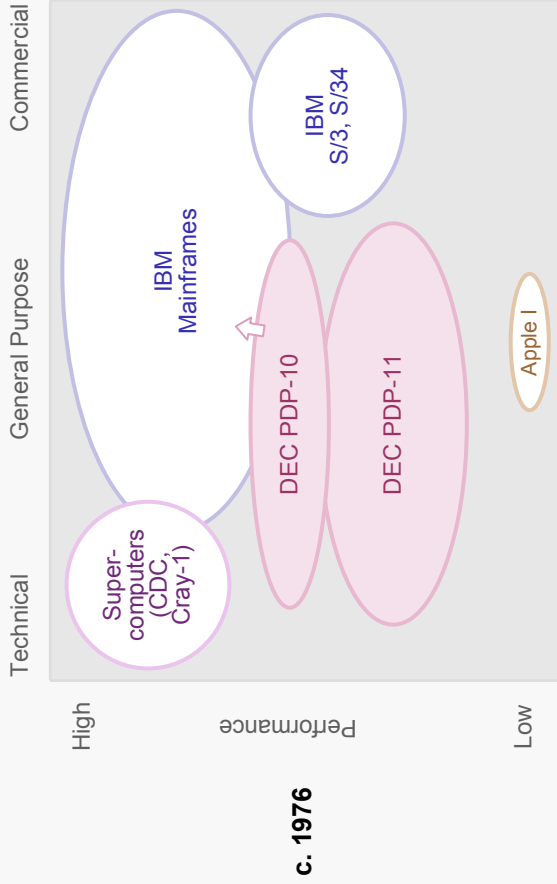

Notes: Only selected systems shown; Size of bubble represents market coverage, not necessarily revenue

DEC Analysis and Lessons Learned Across Its Four Ages

Org' System:	1st Age (1957-65): Creation Establish industry, Transistors	2nd Age (1965-81): Rise ICs: minicomputers form	3rd Age (1981-92): Plateau (The PC Industry forms...)	4th Age (1992-98): Decline (Scalable Computers take all)
Execution/ Results	<ul style="list-style-type: none"> •DEC sells modules to generate early revenue stream and profits •DEC introduces first PDP's in search of the right formula for small, interactive computers 	<ol style="list-style-type: none"> 1.PDP-8 is first big, high volume hit 2.PDP-11, VAX, and DECnet introduced and succeed wildly 3.16-bit and 32-bit microprocessors powering PCs and workstations emerge as potential disruptive technologies 	<ol style="list-style-type: none"> 1.Rainbow/DECmate/Pro fail against IBM PC 2.Sun successfully attacks VAX with UNIX and RISC ('87) in tech market 3.DEC unsuccessfully attacks IBM with VAX 9000 and services 4.DEC has burst of success in '85-'87 with high-end VAXes, DECnet, Office 	<ol style="list-style-type: none"> 1.Alpha introduced and experiences only limited success, mostly in VAX base 2.DEC sells almost exclusively to installed base 3.DEC services misses systems integration wave that IBM catches
Steering/ Infrastructure	<p>1.DEC wisely attacked an uncontested market space</p> <ol style="list-style-type: none"> 1.Company organized by function 2.Multiple projects allowed to proceed in parallel 3.Computer architect Ben Gurley leaves <p>1.Product innovation and organizational innovation were closely linked, both reflecting the culture</p>	<ol style="list-style-type: none"> 1.DEC's innovation focus paid off 2.DEC was a pioneer in knowledge mgt using email & VAXnotes <ol style="list-style-type: none"> 1.DEC's strategy is "offensive" 2.Product lines and matrixed functions established 3.Gordon creates networked VAX strategy 4.Kaufmann and Mazarrese leave <p>1.Two sort-of-in-a-box (Ken and Gordon) worked well</p> <p>2.DEC pioneered product lines plus matrixed functions org' structure</p>	<ol style="list-style-type: none"> 1.DEC unwisely attacked IBM head-on 2.DEC's Bias A culture caused prod's to be late, expensive, and closed <ol style="list-style-type: none"> 1.DEC strategy becomes "defensive" 2.Ken moves from devil's advocate to advocate 3.Product lines abolished 4.Gordon Bell and many execs leave 5.Smith and Shields consolidate power <p>•DEC org' structure did not change when industry structure changed</p> <p>•DEC failed to grow general managers</p> <p>1.DEC's consensus decision-making was poorly suited for hard choices</p>	<p>1.DEC's big service org wasn't good at systems integration due to lack of discipline, standard methods</p> <ol style="list-style-type: none"> 1.Palmer is named CEO, hires many new execs, and moves to "market driven" organization 2.Palmer's reorganization fails and many new execs leave 3.Massive layoffs and sell-offs <p>•DEC's weak board was a liability, waiting too long to act</p> <p>•DEC's board should have gone for an outside CEO</p>
Vision/ Drive	<ol style="list-style-type: none"> 1.DEC's founding vision is to build affordable, interactive computers 2.Everyone is encouraged to innovate <p>1.DEC attracted and hired the best and the brightest early, building a strong base for future leadership</p>	<ol style="list-style-type: none"> 1.DEC's vision of computing is widely accepted by the market 2.Entrepreneurial engineers move into many related product categories <p>1.DEC was highly imprinted by this "heyday" era of great success, making changes in future more difficult</p>	<ol style="list-style-type: none"> 1.DEC's timesharing vision runs out of gas as client-server emerges 2.Self-managing culture turns into "country club" as company politicizes <p>1.DEC's vision was not "built to last"</p> <p>2.DEC's high levels of org' autonomy and internal competition were barriers to process innovation and low cost</p>	<ol style="list-style-type: none"> 1.No new vision emerges for reinventing DEC 2.Layoffs demoralize DEC culture <p>1.Cost cutting without new vision was not sufficient to reinvent a company</p>
Culture	<ul style="list-style-type: none"> •Ken adapts MIT/Lincoln Labs culture to DEC in creating a Bias A culture •Ken started early in making culture a strategic weapon at DEC 	<ul style="list-style-type: none"> •Bias A culture proliferates and takes hold as it is reinforced by much success <p>DEC's heavily Bias A culture was well aligned with pre-dominant design stage of industry</p>	<ul style="list-style-type: none"> •Bias A culture becomes maladapted and resists change toward Bias B •"Family responsibility" of culture gets in the way of needed layoffs <p>•DEC's heavily optimized Bias A culture didn't evolve well</p> <p>•The culture was difficult to change with the founder present</p>	<ul style="list-style-type: none"> •Bias A culture resists change even with new management •The reclusive Palmer was not well-suited to lead cultural change •Ken Olsen had been too central to culture, making succession hard

Dominant Design Emerges

Key Events Across DEC's Four Ages

First Age (1957-65)	Second Age: A (1965-75), B (1975-81)	Third Age (1981-1992)	Fourth Age (1992-98)
Technology:			
1958: Integrated circuit – SSI 1964: Automated wirewrap	1965: MSI 1969: LSI, Arpanet 1970: UNIX 1972: 8-Bit microprocessor	1981: Graphical User Interface 1986: RISC architecture	1993: World Wide Web
Products:			
1957: Logic modules 1961: PDP-1 1964: PDP-6,	1965: PDP-8 (1st minicomputer) 1967: PDP-10, PDP-X 1970: PDP-11	1981: Robin (VT-180) 1982: Rainbow, Pro, DECmate II 1983: Jupiter/10s/20/s killed 1984: 8600 1985: MicroVAX II	1992: DEC PC clone 1993: Alpha
Organization:			
1964: Hardware product lines + matrix management	1969: Hired outside P Line mgrs 1970: "Palace Revolt"(Kaufmann) 1972: Market product lines 1972: Doriot joins the board	1974: Central Engr formed (GB) 1974: Components Group (AK) 1978: Service (Shields) spun out from sales (Johnson) 1980: Julie Pita (Bus'n Week) interview of KO	1992: Ken Resigns; replaced by Palmer
People:			
1957: KO, Stan O, Harlan Anders'n 1958: Ted Johnson, Jack Smith 1959: Ben Gurley (left 1962) 1960: Gordon Bell 1961: Jack Shields 1962: Win Hindle, Nick Mazzaresse,	1966: Pete Kaufmann 1966: Harlan Anderson leaves 1966: Gordon Bell goes to CMU 1968: DeCastro left, founded DG 1969: Knowles, Marcus, Cady 1972: Mazzaresse left 1972: Gordon B returns	1981: Stan Olsen left 1982: Ted Johnson left 1983: Gordon Bell (to Encore), Andy Knowles, Julius Marcus, Bob Puffer, Dick Clayton, Larry Portner, Roger Cady, Bernie LaCroute (to Sun), Dave Rogers all left	1992: Ken resigns
Business:			
1967: \$39M rev's, \$4.5M profit	1966: DEC IPO 1974: Enters Fortune 500 (475)	1987: DEC's best year 1987: October '87 black Friday	
Competition:			
1964: IBM 360	1975: IBM S/32 mini 1976: IBM Series/1 1978: Apple II	1981: IBM PC 1982: Sun/UNIX workstation	1993: Microsoft NT

Industry Forces Across DEC's Four Ages

External Context				
Theme:	1st Age (1957-65): Creation	2nd Age (1965-81): Rise	3rd Age (1981-92): Plateau	4th Age (1992-98): Decline
Technology maturity	<ul style="list-style-type: none"> •Computers are moving from vacuum tubes to transistors and early integrated circuits (ICs) •Timesharing is emerging as a more user-friendly computing paradigm than batch •Programming languages emerge, but almost no packaged applications exist (so users must write their own applications) 	<ol style="list-style-type: none"> 1. Timesharing becomes a dominant computing wave 2. Microprocessors emerge in the early '70s, precipitating the emergence of personal computers and workstations in the late '70s 3. The Arpanet and UNIX emerge in 1969 and 1970 respectively, both of which later became the basis of key standards 4. Packaged applications begin to emerge in the mid-1970s 	<ol style="list-style-type: none"> 1. The IBM PC (1981) and client-server architecture emerge as the dominant design of computing 2. High performance RISC (Reduced Instruction Set Computing) architecture hits the market in 1986 3. Microprocessors overtake traditional board-based computers in performance by the end of this age 4. Packaged applications become a driving force as hardware standardizes 	<ol style="list-style-type: none"> 1. The World Wide Web emerges in 1993, running over the Internet (formerly the Arpanet)
Environmental Determinism	<ul style="list-style-type: none"> •Hardware is complicated, unreliable, and proprietary, giving hardware vendors the upper hand 	<ol style="list-style-type: none"> 1. Software vendors emerge in the mid-70s and gain some power, but hardware vendors still have the upper hand 	<ol style="list-style-type: none"> 1. With the emergence of standards (de factor and de jure), software vendors and customers gain power over hardware vendors 	<ol style="list-style-type: none"> 1. Many hardware system vendors become sandwiched between Intel and Microsoft running 3rd party software, resulting in undifferentiated products, and thus losing much market power
Customer Mix	<ul style="list-style-type: none"> •Early adopter companies enter 	<ol style="list-style-type: none"> 1. Early majority companies join early adopters 	<ol style="list-style-type: none"> 1. Late majority companies and early adopter consumers enter 	<ol style="list-style-type: none"> 1. Laggard companies and early majority consumers enter
Competition	<ul style="list-style-type: none"> •Not much direct competition; most computers were expensive and built by IBM and the BUNCH (Burroughs, Univac, NCR, CDC, and Honeywell) 	<ol style="list-style-type: none"> 1. DG, HP, Tandem, IBM, Prime, Wang 	<ol style="list-style-type: none"> 1. Category killers emerge (Microsoft, Intel, Compaq, Dell, Sun, Cisco, EMC, HP printers, Oracle, Lotus, AOL) 	<ol style="list-style-type: none"> 1. Category killers continue to grow, many becoming "800 pound gorillas". Dell's process innovations help drive prices down and gain advantage.
Society	<ul style="list-style-type: none"> •Post-war society knocks down many barriers as women enter the workforce and computers enter the corporation. 	<ol style="list-style-type: none"> 1. Workers want more open access to information and computers, making timesharing and terminals a big success 	<ol style="list-style-type: none"> 1. Workers continue to seek more open access and control of their information destiny, and migrate from terminals to PCs 	<ol style="list-style-type: none"> 1. The World Wide Web and handheld computers give workers even more access and control of their info destiny

The End

* d i g i t a l *

TO: ENG STAFF:
JACK SMITH

DATE: MON 15 FEB 1982 6:55 AM EST
FROM: GORDON BELL
DEPT: ENG STAFF
EXT: 223-2236
LOC/MAIL STOP: ML12-1/A51

SUBJECT: TASK FORCES, COMMITTEES; NOD; C-I T/F; PRODUCTIVITY REV.

I just read the minutes of two meetings of a task force called Customer Installability. It is not a task force it is a sewing circle consisting of 21 people! If there weren't 3 people there who I know have real work to do and have done good work, I would ask that we simply dismiss the whole group.

The minutes contain no real information on the subject. We already have a spec on what CI is, and we have to do some work on products to get it. This is not the work of a committee.

My point, I would like you to come forward with a list of the various committees and task forces, etc that are working within your group during the productivity review. I don't want to look at them, but I expect you to have, and I want to know that you understand what's going on in your area.

I believe 1/2 of these people could be let go from DEC today and our productivity would take a sharp rise. If this is the case, I would like to have their names and since we have the reputation for never firing anyone we can put them in a new group I propose we start called NOD (No Output Division) where they won't take time from people who have real work to do.
PS

I'm quite serious about NOD. Since it is so difficult to get rid of people, I want to make us at least not have them mixed in with the workers and suck up good people's time.

15-FEB-82 06:55:06 S 31987 BURT

NOD: No Output Division

The Technology Balance Sheet

Plan with:
Schedule of
Milestones &
Resources

Eng. Specs:
User view (e.g., data sheets,
manuals) and Features, Functions,
Benefit (FFB)
Eng. view (e.g., product structure,
how to design)

**Quality Design
Methods/Processes**

**External (industry),
internal, & other standards**

**Indigenous (i.e., skills, tools,
& technical know how)
& exogenous technology
base (e.g., patents)**

**Operational Management
(ability to fulfil plans-
specs, resources, schedule)**

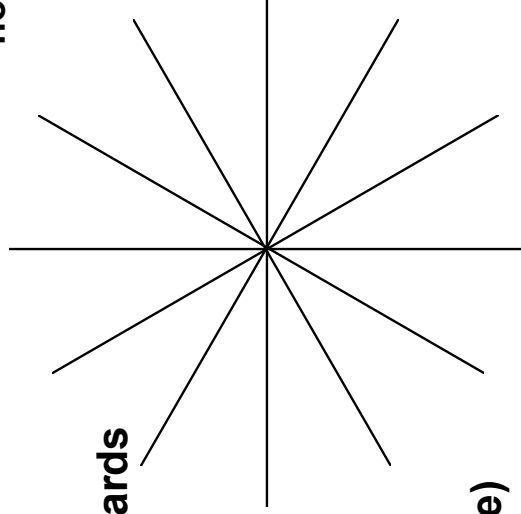

**Manufacturing Specs.
(i.e. How to
Produce Product)**

**Chief Technical Officer
(Eng. VP)**

**Team, Product Architect,
Engineering Culture**

Technology Advisory Board

Technology

Future --

Financeability (Cash / Budget) **\$s**

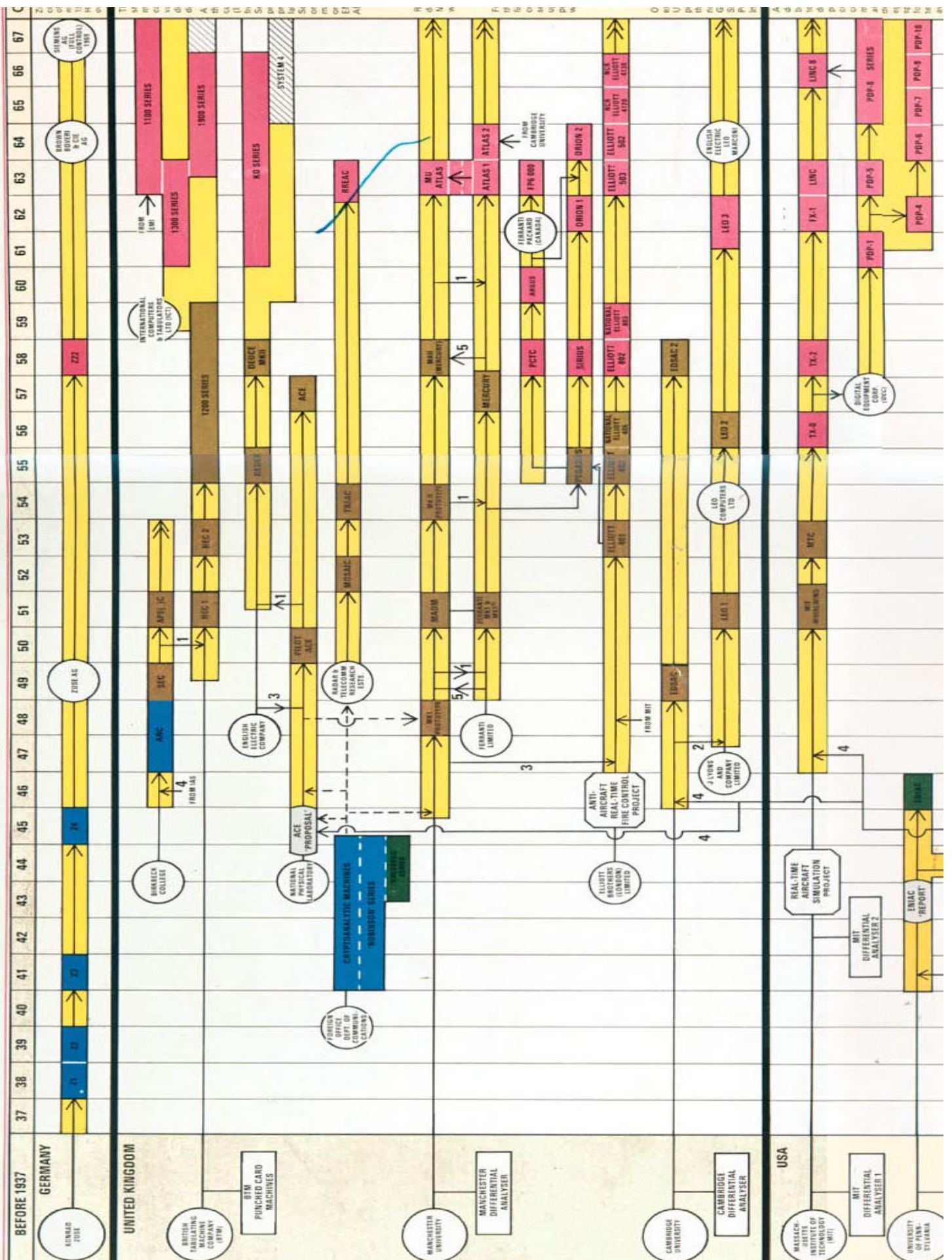

BEFORE 1937

GERMANY

UNITED KINGDOM

MANCHESTER DIFFERENTIAL ANALYSER

CAMBRIDGE DIFFERENTIAL ANALYSER

USA

MIT DIFFERENTIAL ANALYSER 1

MIT DIFFERENTIAL ANALYSER 2

UNIVERSITY OF PENNSYLVANIA

ENIAC REPORT