

CSE/EE 576
Computer Vision
Spring 2010

Professor Linda Shapiro
TA: Indriyati Atmosukarto (Indri)

Introduction

- What IS computer vision?

the analysis of digital images by a computer

- Where do images come from?

Applications: Medical Imaging

CT image of a
patient's abdomen



Visible Man Slice Through Lung

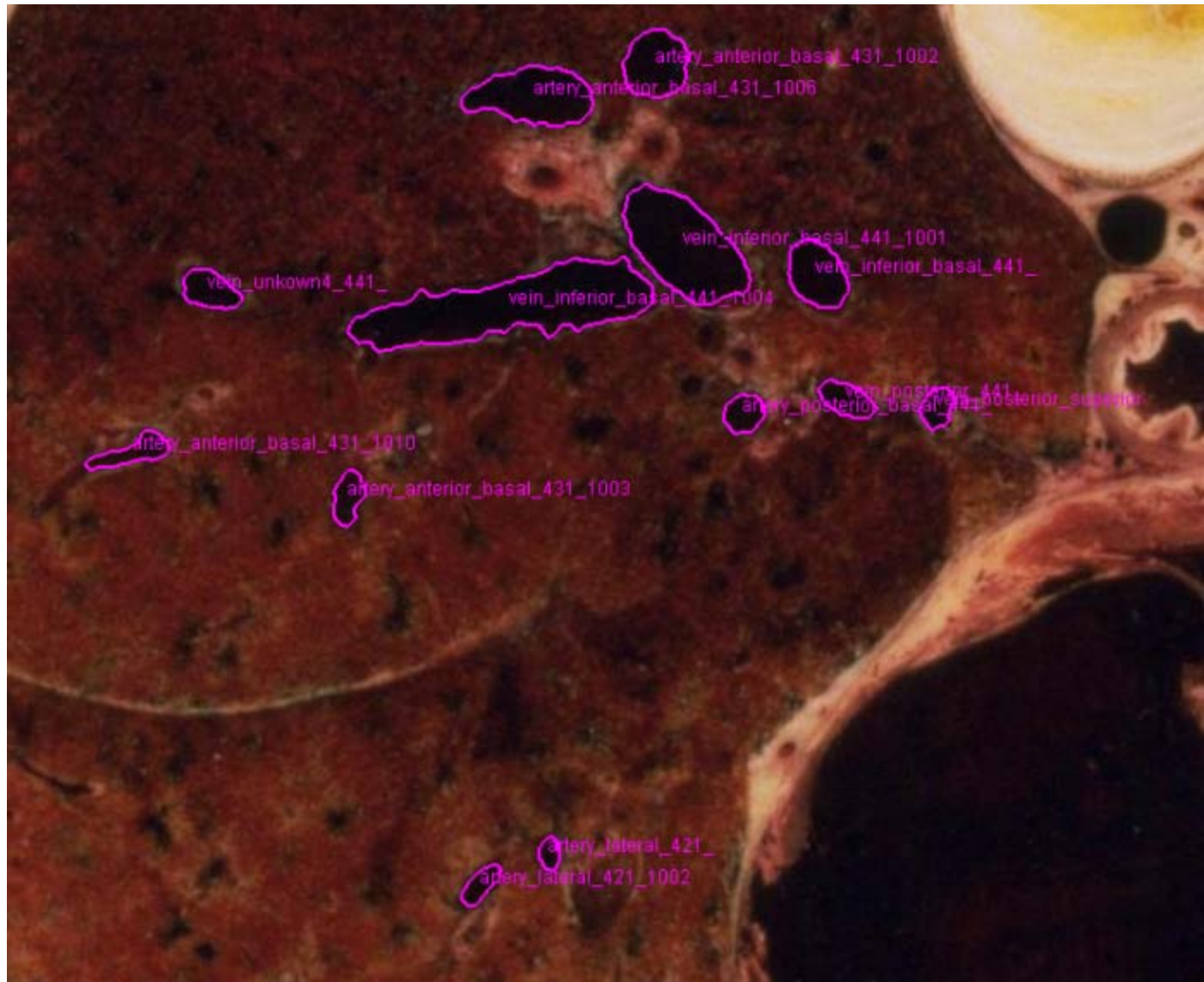

3D Reconstruction of the Blood Vessel Tree

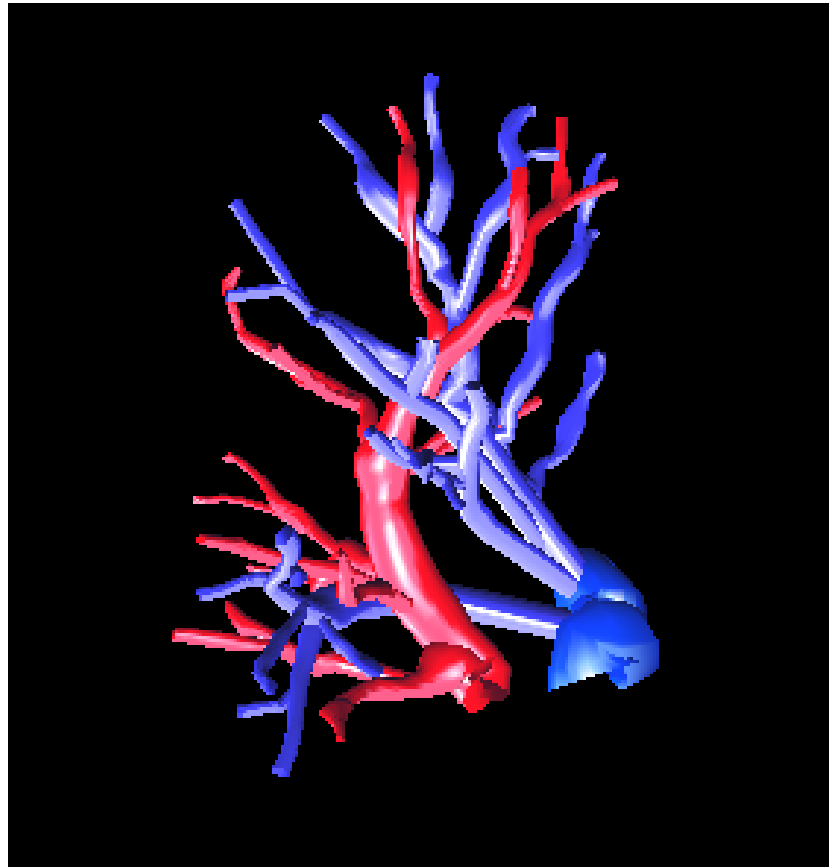

Slice of a Chicken Embryo's Inner Ear

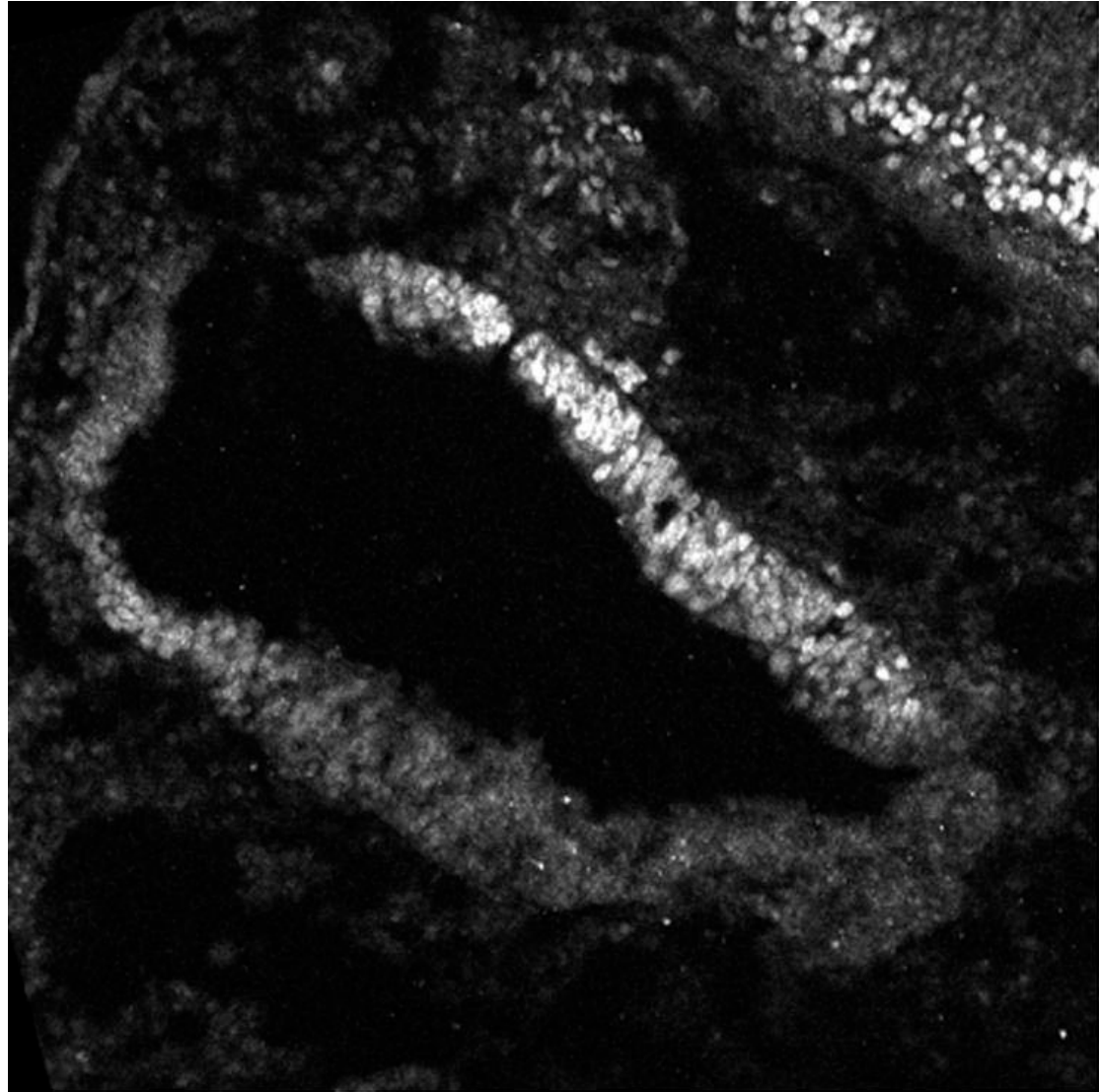

CBIR of Mouse Eye Images for Genetic Studies



Robotics

- 2D Gray-tone or Color Images

“Mars” rover



- 3D Range Images

What am I?

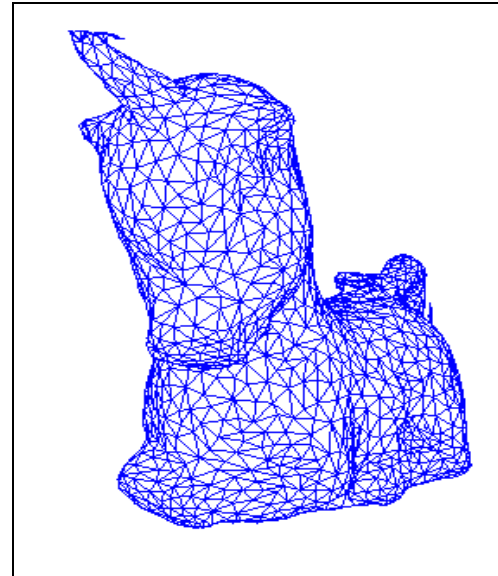

- Robot Soccer

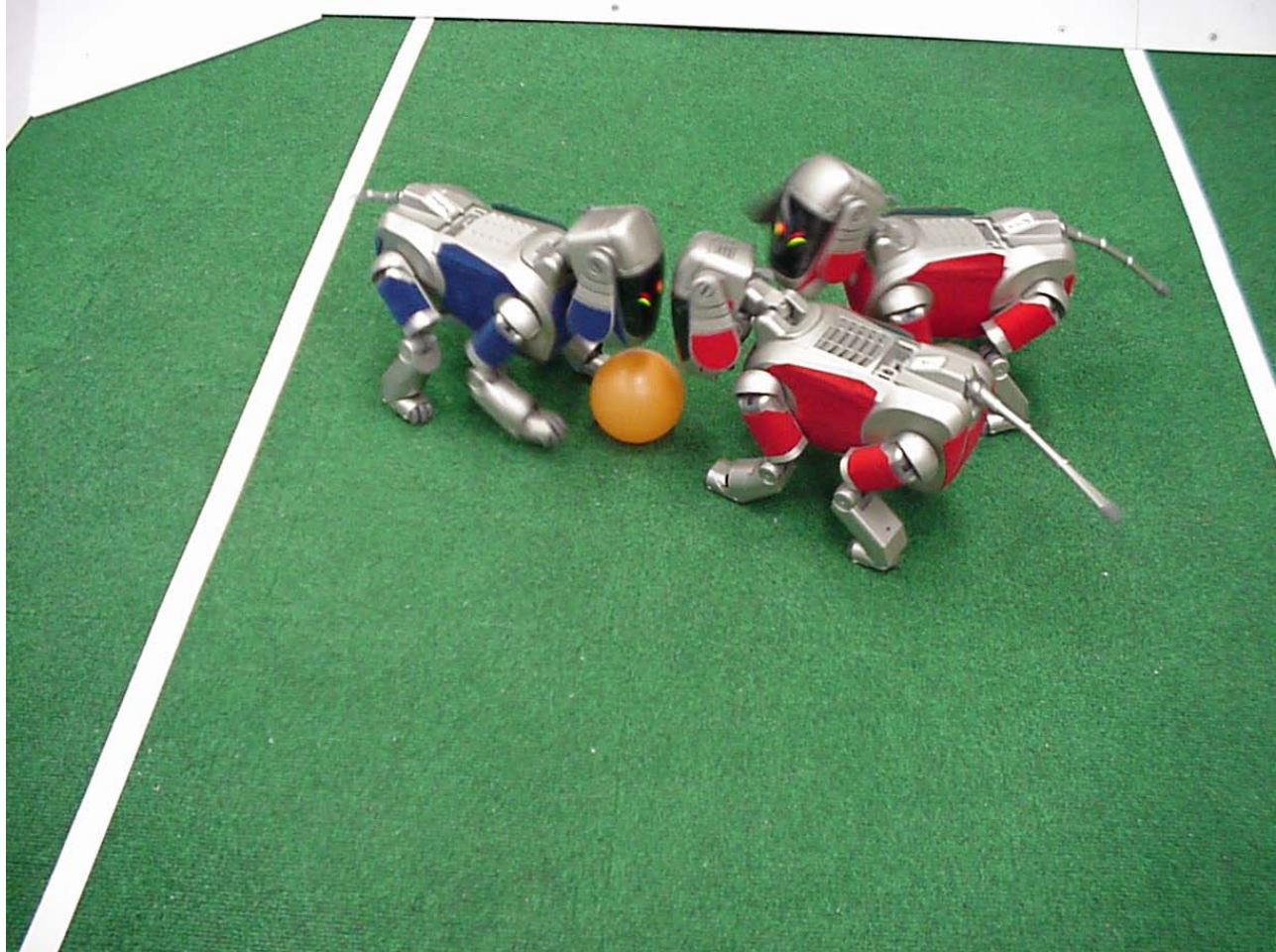

Image Databases:

Images from my Ground-Truth collection:

<http://www.cs.washington.edu/research/imagedatabase/groundtruth>



- retrieve images containing trees

Some Features for Image Retrieval

Original Images

Color Regions

Texture Regions

Line Clusters

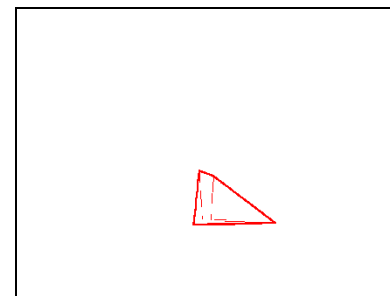
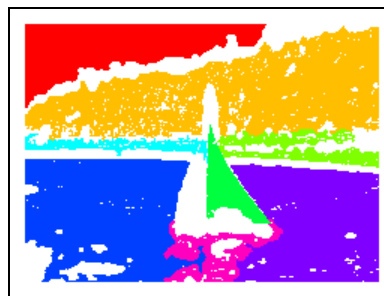
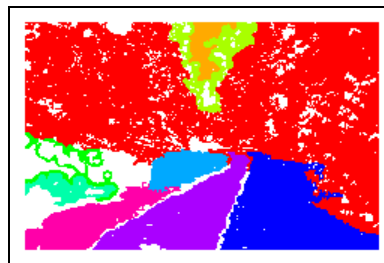
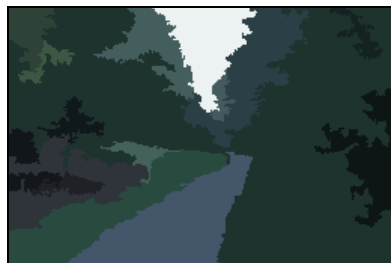
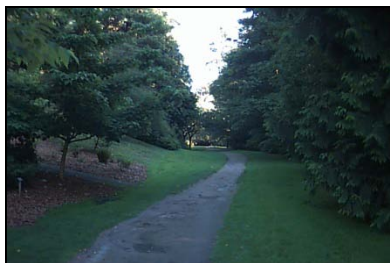
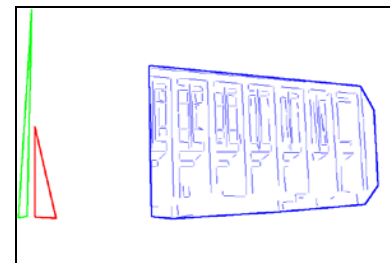
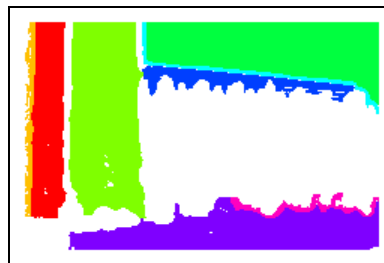

Documents:

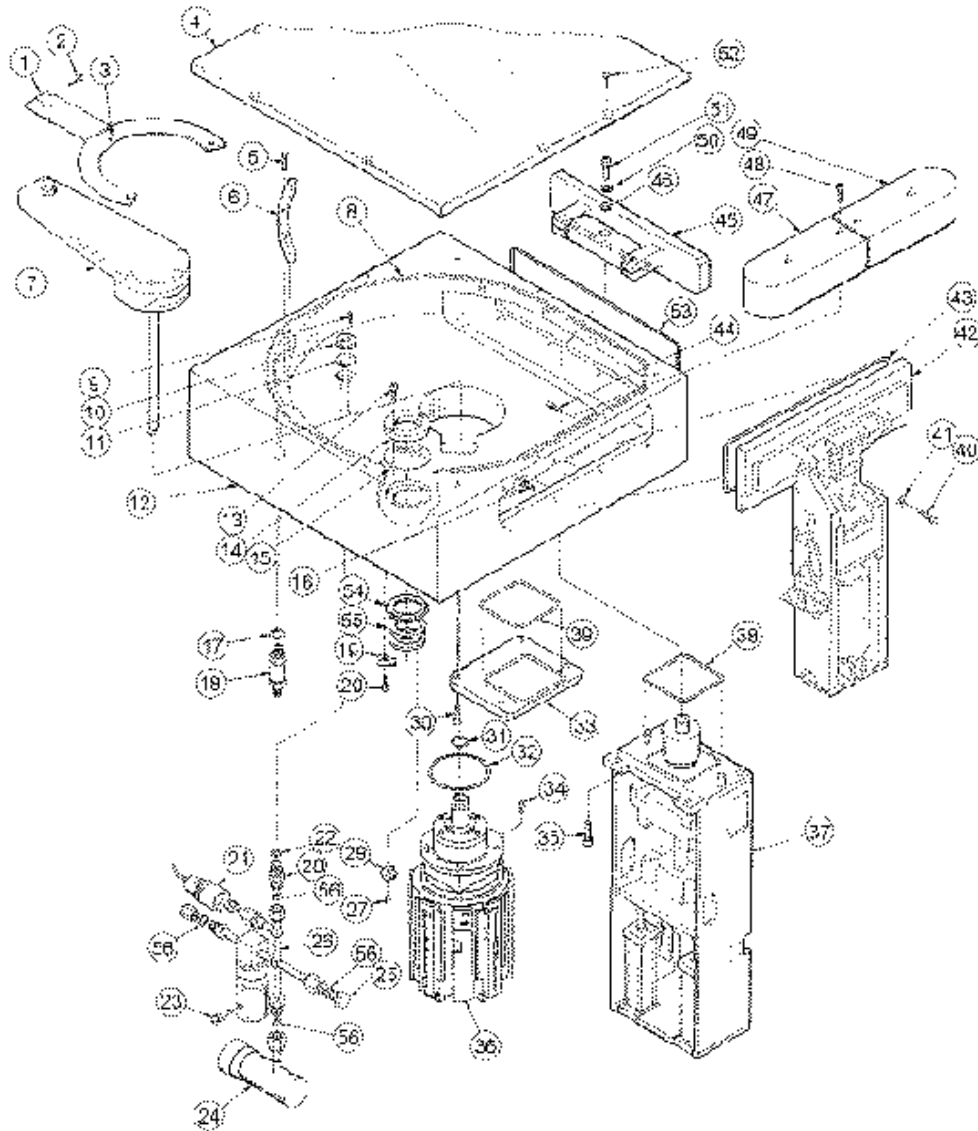

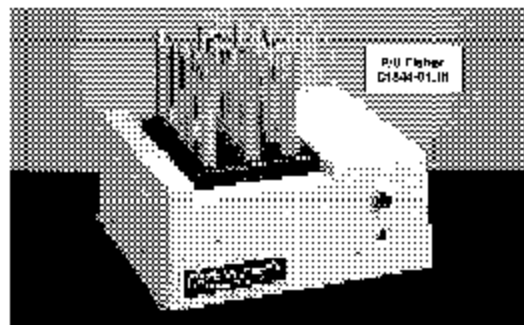

Model 145 Isotemp® Dry Bath Incubator

- Holds 1 to 4 heating blocks with choice of 11 well sizes
- Maintains every sample in within $\pm 0.1^\circ\text{C}$ of temperature

In a sample well, the shape so that a uniform circle delivers same amount of heat to all parts of the sample tube. No lameness, no gradient— neither on top of the bottom nor on cold or the top—that may invalidate tests. In tubes with drilled or indented walls. Sample tubes rest on insulating rings. No present localized heating. A low cost, density heater is mounted on a thick 1/4" alumina heat reflecting plate in the front of the bath. Plate is 1/2" thick, 5.5 mm. Dry bath maintains cleaner problems because tubes & wax stop.

Ambient to 125°C (255°F) with $\pm 0.1^\circ\text{C}$ control. Dial temperature controlled from 25° to 255°C. Ideal for enzyme reactions, inoculation of sera, Rh studies, blood cross-matching and bioassay determinations. Dimensions: 8.1 x 15.5" x 4" H. 128 x 28 x 11 cm. With top cover and plug. Heating blocks sold separately (see lower right).

Electrical Requirements	Cat. No.	Each
120V, 60Hz, 300W (CSA approved)	11-715-100	219.50
240V, 50/60Hz, 800W	11-715-101	306.00

Storage and/or Loan Contact: 317-370-2000
Pacemaker Model

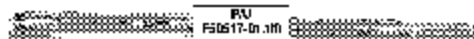

Incu-Block® Partial Immersion Thermometers

For all standard bath, ice blocks and water baths. Critical temperatures (25°, 30°, 37°, 56° C) are marked with arrows. Available with stainless steel, contamination proof Teflon® coating. Total length: 1.75 mm. In immersion: 35 mm.

Range, °C	Dia., cm	Teflon Coated	Cat. No.	Each
25-57	0.5	Yes	14-992	45.00
25-57	0.5	No	14-993	46.00

More Thermometers

For more thermometers, including digital types,

see page 952

Model 147 Isotemp® Dry Bath

- Holds single heating block with choice of 11 well sizes

Similar to Model 145, but with 35" thick (2.0 mm) plate. Ideal for labs with smaller volumes of enzyme and carbohydrate assays. Rh studies, and dry incubators. Forward heat-adjusted temperature control between ambient and 98°C (204°F). Observe thermometer panel in use. Sample tubes rest on adjust control, rough hole in front panel. Maintains set temperature with consistency and uniformity $\pm 0.05^\circ\text{C}$.

Supplier with strong nylon case. Thermistorally controlled heater and indicator amp. line case and plug. See instructions. Dimensions: 8.1 x 6.5" W x 3" H. 11.5 x 17 x 8 cm. CSA approved. Heating blocks sold separately (see below).

Electrical Requirements	Cat. No.	Each
120V 50/60Hz, 120W	11-715-102	223.50

Interchangeable Heating Blocks for Isotemp® Dry Baths

For Models 145 and 147 Dry Baths. Composed of black anodized aluminum alloy. (Chemical resistant). Dimensions: 1 x 0.75 x 1.25" H (25 x 19 x 32 mm).

The 11-715-123 block provides a safe dry bath alternative for warming 1-20 Spalte of tissue loops. Avoids hazardous use of burners and inflammable biological reagents.

The 11-715-120 block is specifically designed to hold twenty 9.5 mm Bertho Diagnostics Placenta® pregnancy test tubes. This special shallow well block is similar to the other blocks with 0.9 mm holes, but sample wells are only 1/2" deep (1.0 cm) to meet test requirements. Wells in all other blocks are 1 1/2" deep (1.4 cm).



Tube Size, mm	Wells/Block	Cat. No.	Each
6	35	11-715-105	71.00
8	20	11-715-107	71.00
10	20 (see below)	11-715-120	71.00
12	12	11-715-108	71.00
12.5	12	11-715-121	71.00
13	12	11-715-111	71.00
15	12	11-715-113	71.00
16	8	11-715-122	71.00
18	12	11-715-115	71.00
21	6	11-715-117	71.00
25	5	11-715-119	71.00

Incubation chamber
For use with 120V 50/60Hz, 120W (CSA approved) electrical power

Science



Classification Results:

Classified	as Cal	as Yor
Cal	171	16
Yor	0	99

Classified	as Cal	as Dor
Cal	114	72
Dor	70	133

Surveillance: Event Recognition in Aerial Videos



Original Video Frame

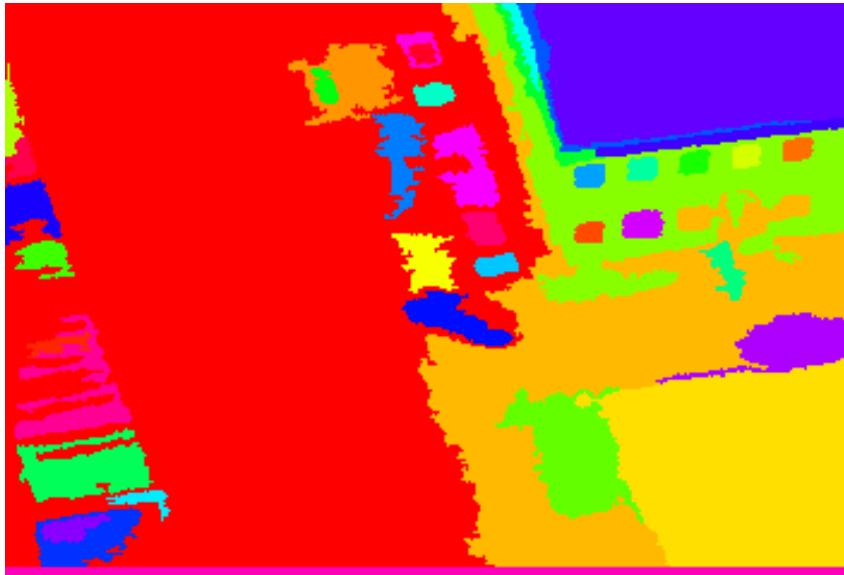

Color Regions



Structure Regions

Face Detection (and Recognition)



Graphics: Special Effects



Andy Serkis, Gollum, Lord of the Rings

3D Reconstruction and Graphics Viewer

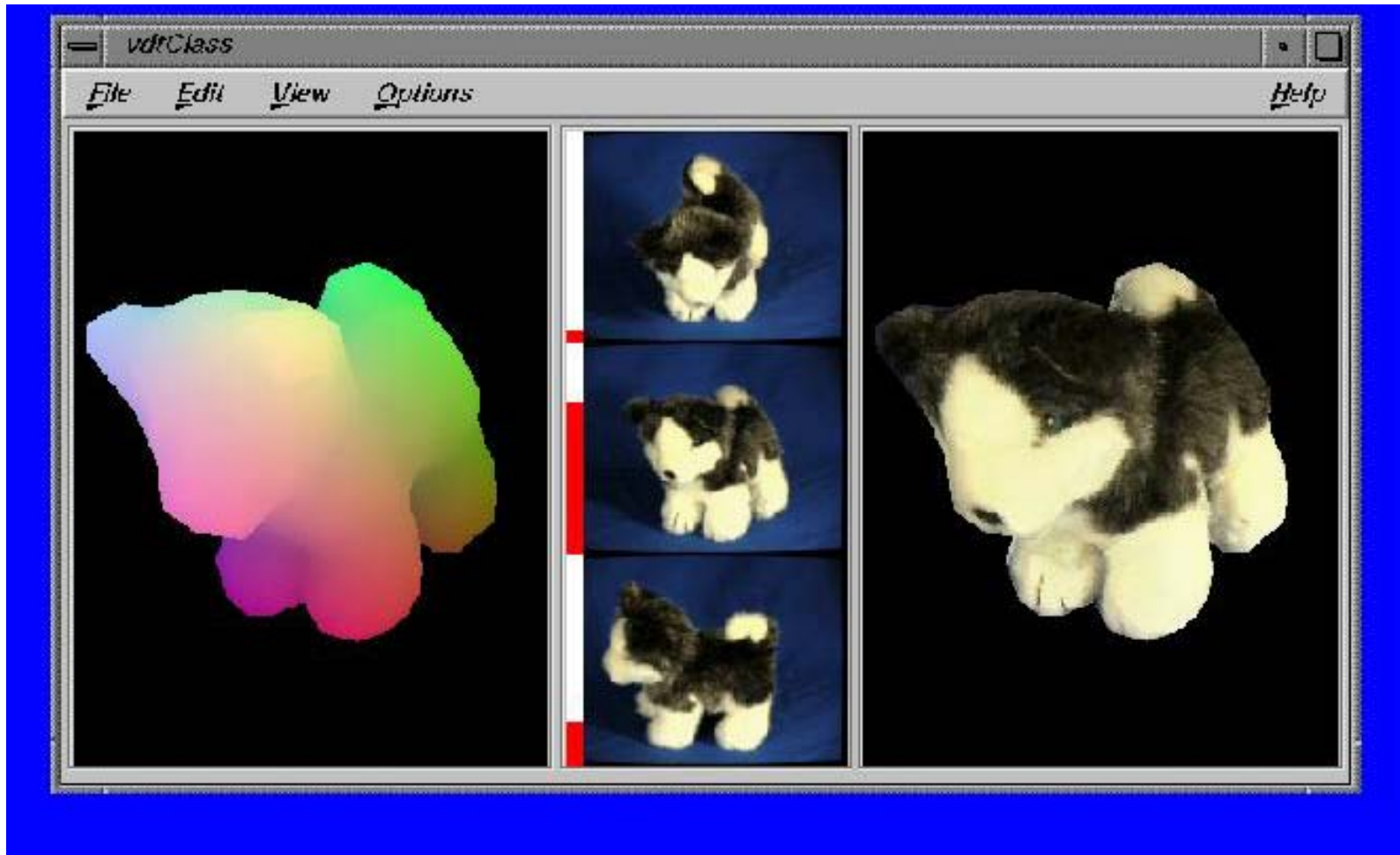

Object Recognition from “Parts”

Part 1 – Det:5e-18

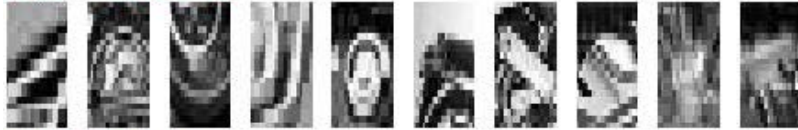

Part 2 – Det:8e-22



Part 3 – Det:6e-18

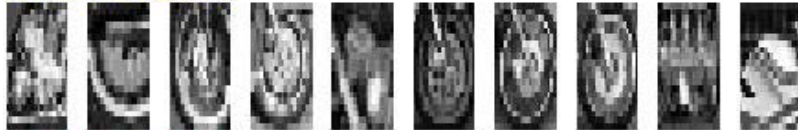

Part 4 – Det:1e-19

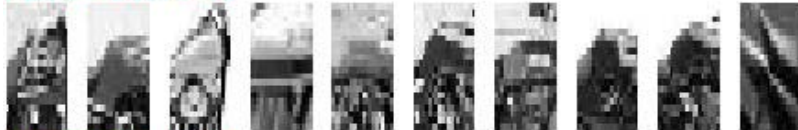

Part 5 – Det:3e-17

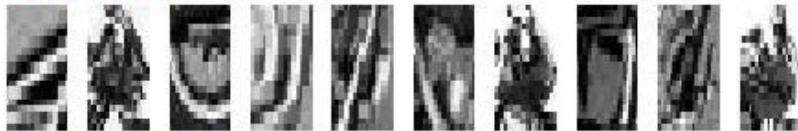

Part 6 – Det:4e-24



Background – Det:5e-19



Motorbike shape model

